

| | | |
|--|---|----|
| Pictorial index | Search by illustration | |
| For safety and security | Make sure to read through them (Main topics: Child seat, theft deterrent system) | 1 |
| Electric Vehicle system | Reading charging-related information (Main topics: Electric Vehicle system, charging methods) | 2 |
| Vehicle status information and indicators | Reading driving-related information (Main topics: Meters, multi-information display) | 3 |
| Before driving | Opening and closing the doors and windows, adjustment before driving (Main topics: Keys, doors, seats) | 4 |
| Driving | Operations and advice which are necessary for driving (Main topics: Starting Electric Vehicle system, driving support systems) | 5 |
| Interior features | Usage of the interior features (Main topics: Air conditioner, storage features) | 6 |
| Maintenance and care | Caring for your vehicle and maintenance procedures (Main topics: Interior and exterior, light bulbs) | 7 |
| When trouble arises | What to do in case of malfunction and emergency (Main topics: 12-volt battery discharge, flat tire) | 8 |
| Vehicle specifications | Vehicle specifications, customizable features (Main topics: Fluids, tire inflation pressure) | 9 |
| For owners | Reporting safety defects for U.S. owners, and seat belt, SRS airbag and headlight aim instructions for Canadian owners | 10 |
| Index | Search by symptom | |
| | Search alphabetically | |

| | | | |
|--|----|--|-----|
| For your information..... | 7 | 2-2. Charging | |
| Reading this manual..... | 12 | Charging equipment..... | 85 |
| How to search..... | 13 | AC charging cable..... | 87 |
| Pictorial index..... | 14 | Locking and unlocking AC charging connector..... | 93 |
| 1 For safety and security | | Power sources that can be used..... | 96 |
| 1-1. For safe use | | Charging methods..... | 98 |
| Before driving..... | 26 | Charging tips..... | 100 |
| For safe driving..... | 27 | Things to know before charging..... | 102 |
| Seat belts..... | 29 | How to use AC charging | 105 |
| SRS airbags..... | 34 | How to use DC charging | 113 |
| Front passenger occupant classification system..... | 44 | Using the charging schedule function..... | 118 |
| 1-2. Child safety | | Using My Room Mode... | 129 |
| Riding with children..... | 49 | When charging cannot be carried out..... | 133 |
| Child restraint systems..... | 50 | 3 Vehicle status information and indicators | |
| 1-3. Emergency assistance | | 3-1. Instrument cluster | |
| Safety Connect..... | 64 | Warning lights and indicators | 148 |
| 1-4. Theft deterrent system | | Gauges and meters..... | 152 |
| Immobilizer system..... | 68 | Multi-information display | 155 |
| Alarm..... | 69 | 4 Before driving | |
| 2 Electric Vehicle system | | 4-1. Key information | |
| 2-1. Electric vehicle system | | Keys..... | 162 |
| Electric Vehicle system fea- tures..... | 72 | Digital key..... | 165 |
| Electric Vehicle system pre- cautions..... | 76 | | |
| Battery Electric Vehicle driv- ing tips..... | 81 | | |
| Driving range..... | 83 | | |

| | | |
|---|---|--|
| <p>4-2. Opening, closing and locking the doors Side doors 167 Back door 172 Smart key system 187</p> <p>4-3. Adjusting the seats Front seats 192 Rear seats 193 Head restraints 196</p> <p>4-4. Adjusting the steering wheel and mirrors Steering wheel 199 Inside rear view mirror .. 200 Digital Rear-view Mirror 201 Outside rear view mirrors 210</p> <p>4-5. Opening, closing the windows Power windows 212</p> <p>4-6. Favorite settings My Settings 215</p> | <p>5 Driving</p> <p>5-1. Before driving Driving the vehicle 219 Cargo and luggage 225 Vehicle load limits 228 Trailer towing 229 Dinghy towing 230</p> <p>5-2. Driving procedures Power (ignition) switch .. 231 Transmission 236 Turn signal lever 242 Parking brake 243 Brake Hold 246</p> <p>5-3. Operating the lights and wipers Headlight switch 248 AHB (Automatic High Beam) 250 Windshield wipers and washer 253</p> | <p></p> <p>1</p> <p>2</p> <p>3</p> <p>4</p> <p>5</p> <p>6</p> <p>7</p> <p>8</p> <p>9</p> <p>10</p> |
|---|---|--|

5-4. Using the driving support systems

| | |
|--|-----|
| Software update | 257 |
| Toyota Safety Sense 3.0 | 259 |
| PCS (Pre-Collision System) | 265 |
| LTA (Lane Tracing Assist) | 276 |
| LDA (Lane Departure Alert) | 281 |
| RSA (Road Sign Assist) | 286 |
| Dynamic radar cruise control | 288 |
| Cruise control | 296 |
| Emergency Driving Stop Sys- tem | 299 |
| BSM (Blind Spot Monitor) | 302 |
| SEA (Safe Exit Assist)... | 307 |
| Intuitive parking assist... | 311 |
| RCTA (Rear Cross Traffic Alert)..... | 322 |
| RCD (Rear Camera Detec- tion) | 328 |
| PKSB (Parking Support Brake)..... | 331 |
| Static Objects Front and Rear of the Vehicle..... | 336 |
| Moving Vehicle Rear of the Vehicle..... | 339 |
| Pedestrians Rear of the Vehi- cle..... | 340 |
| Static Objects Around the Vehicle (vehicles with Advanced Park)..... | 342 |
| Toyota Teammate Advanced Park..... | 344 |
| Snow mode | 382 |

| | |
|---------------------------|-----|
| X-MODE | 382 |
| Driving assist systems... | 387 |

5-5. Driving tips

| | |
|--------------------------------------|-----|
| Winter driving tips..... | 393 |
| Utility vehicle precautions | 396 |

6 Interior features**6-1. Using the air conditioning system and defogger**

| | |
|--|-----|
| ALL AUTO ("ECO") control | 400 |
| Automatic air conditioning system | 402 |
| Remote Air Conditioning Sys- tem | 409 |
| Heated steering wheel/seat heaters/seat ventila- tors/radiant heater | 411 |

6-2. Using the interior lights

| | |
|----------------------------|-----|
| Interior lights list | 415 |
|----------------------------|-----|

6-3. Using the storage features

| | |
|---|-----|
| List of storage features.. | 418 |
| Luggage compartment fea- tures | 421 |

**6-4. Using the other interior fea-
tures**

| | |
|-----------------------------|-----|
| Electronic sunshade | 426 |
| Other interior features ... | 428 |
| Garage door opener | 439 |

7 Maintenance and care

7-1. Maintenance and care

- Cleaning and protecting the vehicle exterior 448
- Cleaning and protecting the vehicle interior 451

7-2. Maintenance

- Maintenance requirements 455
- General maintenance.... 456
- Emission inspection and maintenance (I/M) programs 459

7-3. Do-it-yourself maintenance

- Do-it-yourself service precautions..... 460
- Hood 462
- Positioning a floor jack.. 464
- Motor compartment..... 465
- Tires 472
- Replacing the tire 485
- Tire inflation pressure.... 491
- Wheels 493
- Air conditioning filter..... 494
- Electronic key battery.... 497
- Checking and replacing fuses 499
- Headlight aim 501
- Light bulbs..... 502

8 When trouble arises

8-1. Essential information

- Emergency flashers..... 504
- If your vehicle has to be stopped in an emergency 505
- If the vehicle is submerged or water on the road is rising 506

8-2. Steps to take in an emergency

- If your vehicle needs to be towed 507
- If you think something is wrong..... 511
- If a warning light turns on or a warning buzzer sounds 513
- If a warning message is displayed..... 522
- If you have a flat tire 527
- If the EV system will not start 537
- If you lose your keys..... 539
- If the electronic key does not operate properly 539
- If the 12-volt battery is discharged 541
- If your vehicle overheats 545
- If the vehicle becomes stuck 547

1

2

3

4

5

6

7

8

9

10

9 Vehicle specifications**9-1. Specifications**

Maintenance data 550

Tire information 556

9-2. Customization

Customizable features .. 566

9-3. Initialization

Items to initialize 577

10 For owners**10-1. For owners**Reporting safety defects for
U.S. owners..... 580Reporting safety defects for
Canadian owners 581Seat belt instructions for
Canadian owners (in
French) 581SRS airbag instructions for
Canadian owners (in
French) 583Headlight aim instructions for
Canadian owners (in
French) 590**Index**What to do if... (Troubleshoot-
ing) 594

Alphabetical Index 597

For your information

Main Owner's Manual

Please note that this manual applies to all models and explains all equipment, including options. Therefore, you may find explanations for equipment not installed on your vehicle and the illustrations used may differ from your vehicle.

All specifications provided in this manual are current at the time of printing. Over time, your vehicle may receive updates that modify the vehicle and make material in this manual incomplete and/or inaccurate. Because of Toyota's interest in continual product improvement, Toyota reserves the right to make changes to this manual at any time without notice.

If Toyota chooses to update the manual, updated versions can be viewed by selecting your vehicle by model and year at the following URL or on your mobile device if you have access to the Toyota app.

www.toyota.com/owners

Accessories, spare parts and modification of your Toyota

A wide variety of non-genuine spare parts and accessories for

Toyota vehicles are currently available in the market. You should know that Toyota does not warrant these products and is not responsible for their performance, repair, or replacement, or for any damage they may cause to, or adverse effect they may have on, your Toyota vehicle.

This vehicle should not be modified with non-genuine Toyota products. Modification with non-genuine Toyota products could affect its performance, safety or durability, and may even violate governmental regulations. In addition, damage or performance problems resulting from the modification may not be covered under warranty.

Also, remodeling like this will have an effect on advanced safety equipment such as Toyota Safety Sense 3.0 and there is a danger that it will not work properly or the danger that it may work in situations where it should not be working.

Installation of a mobile two-way radio system

The installation of a mobile two-way radio system in your vehicle could affect electronic systems such as:

- EV system
- Toyota Safety Sense 3.0

- Anti-lock brake system
- SRS airbag system
- Seat belt pretensioner system

Be sure to check with your Toyota dealer for precautionary measures or special instructions regarding installation of a mobile two-way radio system.

High voltage parts and cables on the battery electric vehicles emit approximately the same amount of electromagnetic waves as the conventional gasoline powered vehicles or home electronic appliances despite of their electromagnetic shielding.

Unwanted noise may occur in the reception of the mobile two-way radio.

Vehicle data recording

The vehicle is equipped with sophisticated computers that will record certain data, such as:

- Engine speed/ Electric motor speed (traction motor speed)
- Accelerator status
- Brake status
- Vehicle speed
- Operation status of the driving assist systems
- Images from the cameras
Your vehicle is equipped with cameras. Contact your Toyota dealer for the location of recording cameras.

The recorded data varies

according to the vehicle grade level and options with which it is equipped.

These computers do not record conversations or sounds, and only record images outside of the vehicle in certain situations.

● Data Transmission

Your vehicle may transmit the data recorded in these computers to Toyota without notification to you.

● Data usage

Toyota may use the data recorded in this computer to diagnose malfunctions, conduct research and development, and improve quality.

Toyota will not disclose the recorded data to a third party except:

- With the consent of the vehicle owner or with the consent of the lessee if the vehicle is leased
- In response to an official request by the police, a court of law or a government agency
- For use by Toyota in a lawsuit
- For research purposes where the data is not tied to a specific vehicle or vehicle owner

- Recorded image information can be erased by your Toyota dealer.

The image recording function can be disabled. However, if the function is disabled, data from when the system operates will not be available.

- To learn more about the vehicle data collected, used and

shared by Toyota please visit www.toyota.com/privacyvts/.

Usage of data collected through Safety Connect (U.S. mainland only)

If your Toyota has Safety Connect and if you have subscribed to those services, please refer to the Safety Connect Telematics Subscription Service Agreement for information on data collected and its usage.

- To learn more about the vehicle data collected, used and shared by Toyota, please visit www.toyota.com/privacyvts/.

Event data recorder

This vehicle is equipped with an event data recorder (EDR). The main purpose of an EDR is to record, in certain crash or near crash-like situations, such as an air bag deployment or hitting a road obstacle, data that will assist in understanding how a vehicle's systems performed. The EDR is designed to record data related to vehicle dynamics and safety systems for a short period of time, typically 30 seconds or less.

The EDR in this vehicle is designed to record such data as:

- How various systems in your

vehicle were operating;

- Whether or not the driver and passenger safety belts were buckled/fastened;
- How far (if at all) the driver was depressing the accelerator and/or brake pedal; and,
- How fast the vehicle was traveling.

These data can help provide a better understanding of the circumstances in which crashes and injuries occur.

NOTE: EDR data are recorded by your vehicle only if a non-trivial crash situation occurs; no data are recorded by the EDR under normal driving conditions and no personal data (e.g., name, gender, age, and crash location) are recorded. However, other parties, such as law enforcement, could combine the EDR data with the type of personally identifying data routinely acquired during a crash investigation.

To read data recorded by an EDR, special equipment is required, and access to the vehicle or the EDR is needed. In addition to the vehicle manufacturer, other parties, such as law enforcement, that have the special equipment, can read the information if they have access to the vehicle or the EDR.

- Disclosure of the EDR data
Toyota will not disclose the data

recorded in an EDR to a third party except when:

- An agreement from the vehicle's owner (or the lessee for a leased vehicle) is obtained
- In response to an official request by the police, a court of law or a government agency
- For use by Toyota in a lawsuit

However, if necessary, Toyota may:

- Use the data for research on vehicle safety performance
- Disclose the data to a third party for research purposes without disclosing information about the specific vehicle or vehicle owner

Scrapping of your Toyota

The SRS airbag and seat belt pretensioner devices in your Toyota contain explosive chemicals. If the vehicle is scrapped with the airbags and seat belt pretensioners left as they are, this may cause an accident such as fire. Be sure to have the systems of the SRS airbag and seat belt pretensioner removed and disposed of by a qualified service shop or by your Toyota dealer before you scrap your vehicle.

Perchlorate Material

Special handling may apply, See www.dtsc.ca.gov/hazardouswaste/perchlorate.

Your vehicle has components

that may contain perchlorate. These components may include the airbags, seat belt pretensioners, wireless remote control batteries, and the batteries in the tire pressure warning valve and transmitters.

“QR Code”

The word “QR Code” is registered trademark of DENSO WAVE INCORPORATED in Japan and other countries.



WARNING

General precautions while driving

Driving under the influence: Never drive your vehicle when under the influence of alcohol or drugs that have impaired your ability to operate your vehicle. Alcohol and certain drugs delay reaction time, impair judgment and reduce coordination, which could lead to an accident that could result in death or serious injury.

Defensive driving: Always drive defensively. Anticipate mistakes that other drivers or pedestrians might make and be ready to avoid accidents.

Driver distraction: Always give your full attention to driving. Anything that distracts the driver, such as adjusting controls, talking on a cellular phone or reading can result in a collision with resulting death or serious injury to you, your occupants or others.

 **WARNING****■ General precaution regarding children's safety**



Never leave children unattended in the vehicle, and never allow children to have or use the key.

Children may be able to start the vehicle or shift the vehicle into neutral. There is also a danger that children may injure themselves by playing with the side windows, or other features of the vehicle. In addition, heat build-up or extremely cold temperatures inside the vehicle can be fatal to children.

Reading this manual



Explains symbols used in this manual

Symbols in this manual

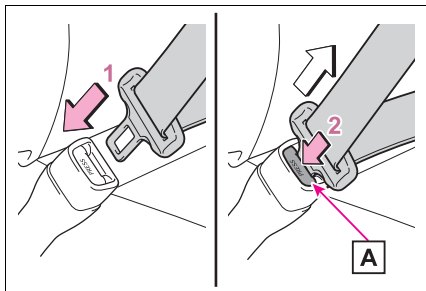

| Symbols | Meanings |
|---|---|
|  | WARNING: Explains something that, if not obeyed, could cause death or serious injury to people. |
|  | NOTICE: Explains something that, if not obeyed, could cause damage to or a malfunction in the vehicle or its equipment. |
| 1 2 3... | Indicates operating or working procedures. Follow the steps in numerical order. |

Symbols in illustrations

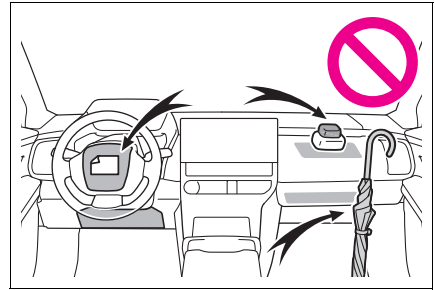

| Symbols | Meanings |
|---|---|
|  | Indicates the action (pushing, turning, etc.) used to operate switches and other devices. |
|  | Indicates the outcome of an operation (e.g. a lid opens). |



| Symbols | Meanings |
|---|--|
|  | Indicates the component or position being explained. |
|  | Means Do not , Do not do this , or Do not let this happen . |

How to search

■ Searching by name

- Alphabetical index: →P.597

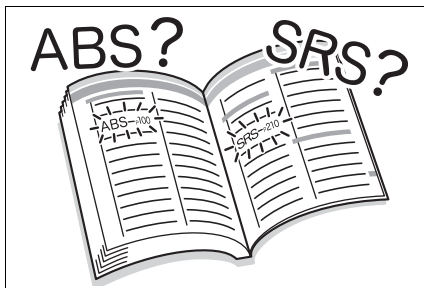

■ Searching by installation position

- Pictorial index: →P.14

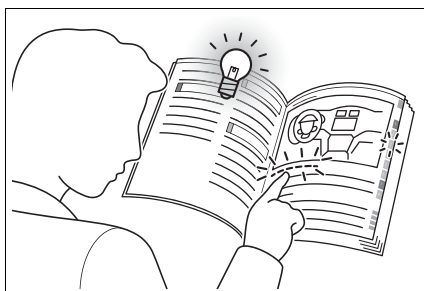

■ Searching by symptom or sound

- What to do if... (Troubleshooting): →P.594

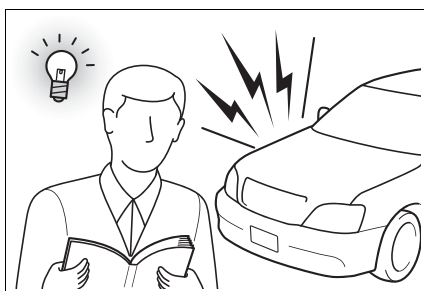

■ Searching by title

- Table of contents: →P.2

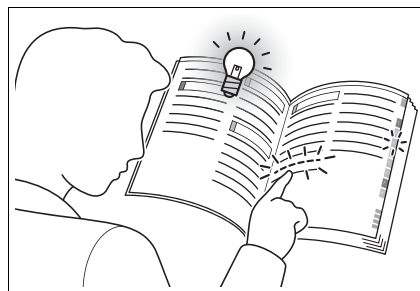

Pictorial index

■ Exterior

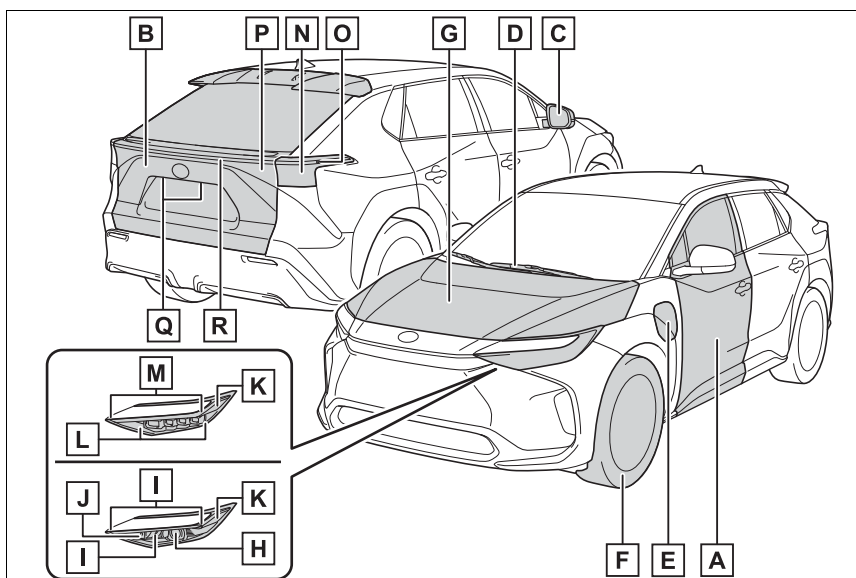

- A Side doors P.167**
 - Locking/unlocking P.167
 - Opening/closing the side windows P.212
 - Locking/unlocking by using the mechanical key P.539
 - Warning messages P.522
- B Back door P.172**
 - Locking/unlocking P.173
 - Opening/closing the back door P.174
 - Warning messages P.522
 - Power back door* P.175
- C Outside rear view mirrors P.210**
 - Adjusting the mirror angle P.210
 - Folding the mirrors P.210
 - Defogging the mirrors P.404
- D Windshield wipers P.253**

| | | |
|----------|---|--------------|
| | Precautions against winter season | P.393 |
| | To prevent freezing (windshield wiper de-icer)* | P.404 |
| | Precautions against car wash (Rain-sensing windshield wipers)* | P.449 |
| E | Charging port | P.85 |
| | Charging method | P.98 |
| F | Tires..... | P.472 |
| | Tire size/inflation pressure | P.555 |
| | Winter tires/tire chain | P.393 |
| | Checking/rotation/tire pressure warning system * | P.472 |
| | Coping with flat tires..... | P.527 |
| G | Hood..... | P.462 |
| | Opening | P.462 |
| | Coping with overheat | P.545 |
| | Warning messages | P.522 |

Light bulbs of the exterior lights for driving

(Replacing method: P.502)

| | | |
|----------|---|--------------|
| H | Headlights/daytime running lights | P.248 |
| I | Parking lights | P.248 |
| J | Turn signal lights | P.242 |
| K | Front side marker lights | P.248 |
| L | Headlights..... | P.248 |
| M | Parking lights/turn signal lights/daytime running lights | P.248 |
| N | Tail lights..... | P.248 |
| | Turn signal lights | P.242 |
| | Stop lights | |
| O | Rear side marker lights | P.248 |
| P | Tail lights..... | P.248 |
| | Back-up light | |

Shifting the shift position to R P.236

Q License plate lights..... P.248

R Tail lights..... P.248

*: If equipped

■ Instrument panel

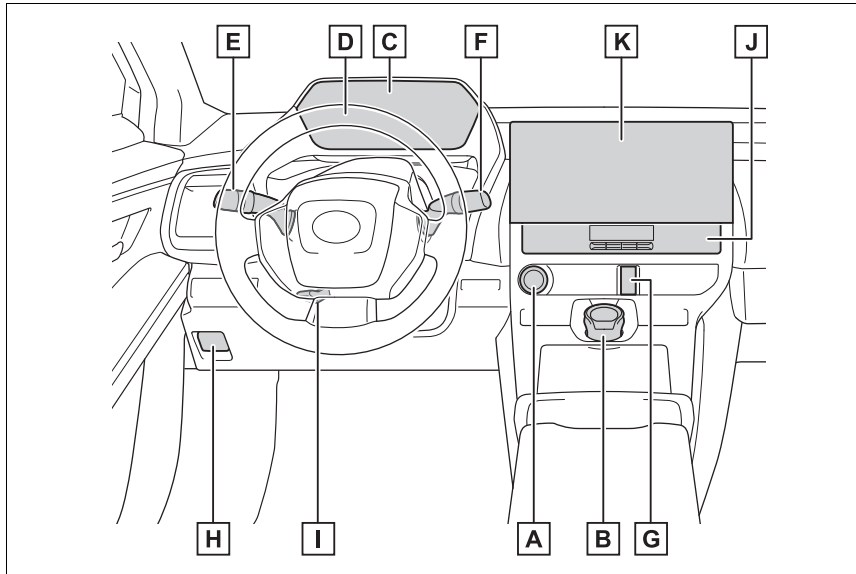

- A Power switch** P.231
 - Starting the EV system/changing the modes P.231, 234
 - Emergency stop of the EV system P.505
 - When the EV system will not start P.537
 - Warning messages P.522
- B Rotary shifter**..... P.237
 - Changing the shift position..... P.237
 - Precautions against towing P.507
- C Meters** P.152
 - Reading the meters/adjusting the instrument panel lightP.152, 155
 - Warning lights/indicator lights P.148
 - When the warning lights come on..... P.513
- D Multi-information display** P.155
 - Display P.155
 - When the warning messages are displayed P.522

| | | |
|----------|---|--------------|
| E | Turn signal lever | P.242 |
| | Headlight switch | P.248 |
| | Headlights/parking lights/tail lights/license plate lights/daytime running lights | P.248 |
| F | Windshield wiper and washer switch | P.253 |
| | Usage..... | P.253 |
| | Adding washer fluid..... | P.471 |
| | Warning messages | P.522 |
| G | Emergency flasher switch | P.504 |
| H | Hood lock release lever | P.462 |
| I | Tilt and telescopic steering lock release lever | P.199 |
| | Adjustment | P.199 |
| J | Air conditioning system | P.402 |
| | Usage..... | P.402 |
| | Rear window defogger | P.404 |
| K | Multimedia system * | |

*: Refer to "MULTIMEDIA OWNER'S MANUAL".

■ Switches

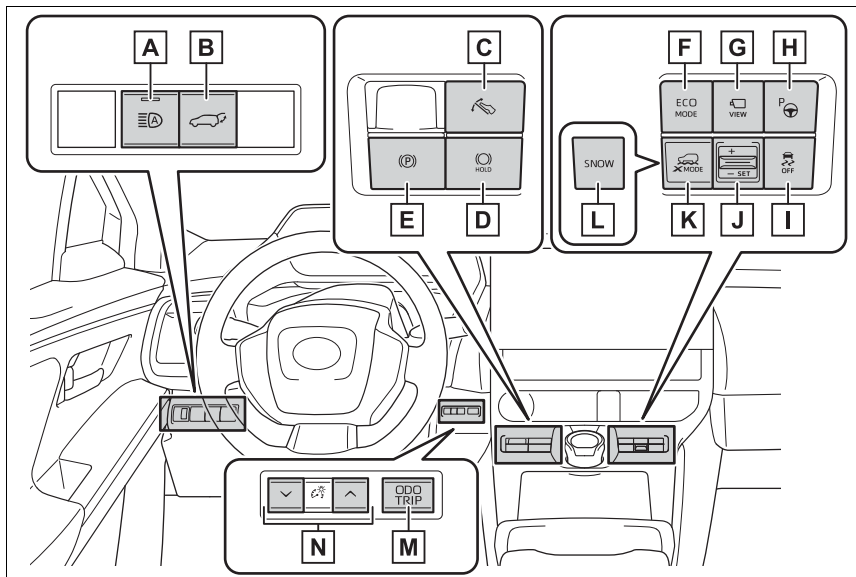

- A Automatic High Beam switch P.250**
- B Power back door switch^{*1} P.176**
- C Regeneration Boost switch..... P.240**
- D Brake hold switch P.246**
- E Parking brake switch P.243**
 Applying/releasing P.243
 Precautions against winter season P.394
 Warning buzzer/message P.245, 522
- F Eco mode switch..... P.241**
- G Camera switch^{*1, 2}**
 Panoramic view monitor^{*1, 2}
- H Advanced Park (parking assist system) main switch^{*1}.. P.344**
- I VSC off switch..... P.388**
- J Grip Control switch^{*1} P.382**

K "X-MODE" switch *1 P.382
L "SNOW" switch *1 P.382
M "ODO TRIP" switch P.154
N Instrument panel light control switches P.155

*1: If equipped

*2: Refer to "MULTIMEDIA OWNER'S MANUAL".

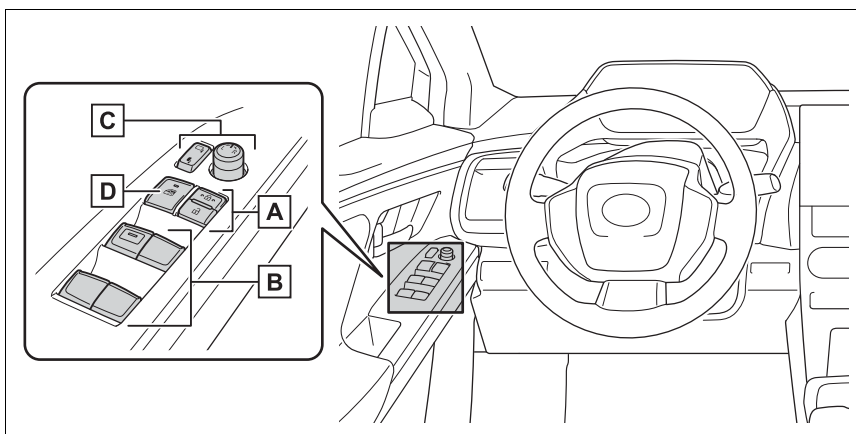

A Door lock switches P.170
B Power window switches P.212
C Outside rear view mirror switches P.210
D Window lock switch P.214

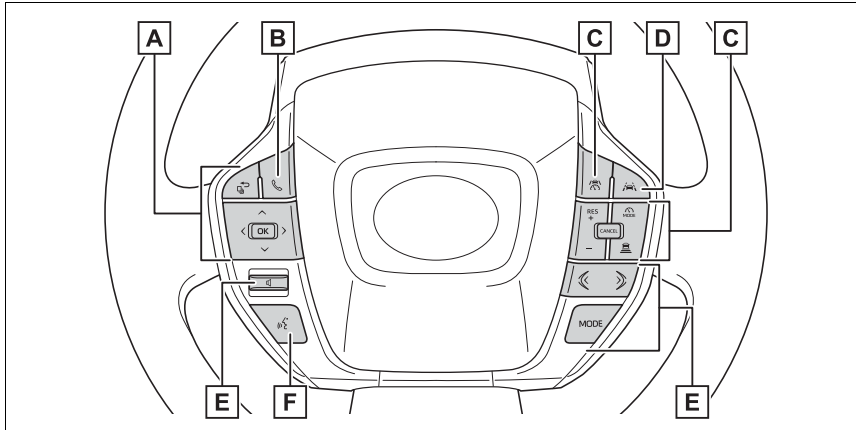

- A Meter control switches P.156**
- B TEL switch* P.156**
- C Cruise control switch**
 - Dynamic radar cruise control P.288
 - Cruise control P.296
- D LTA switch..... P.276, 281**
- E Audio remote control switches***
- F Talk switch***

*: Refer to "MULTIMEDIA OWNER'S MANUAL".

■ Interior

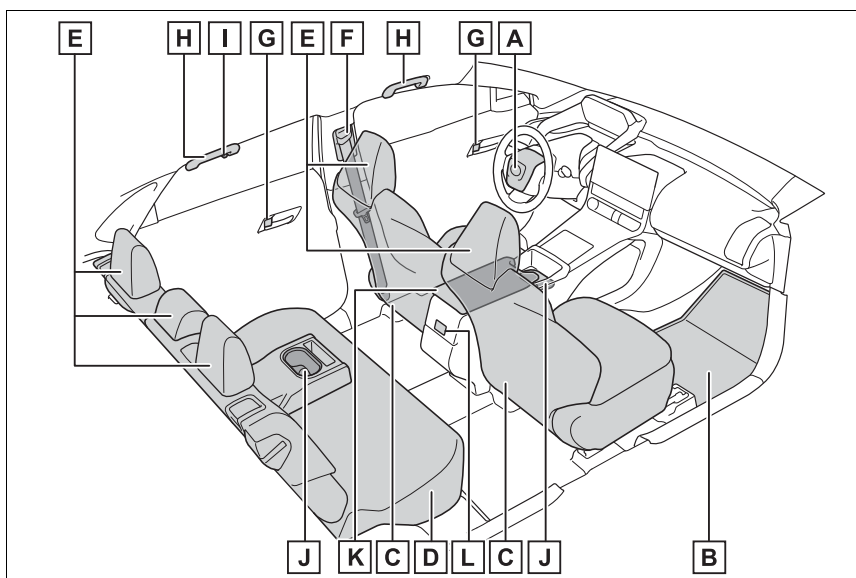

| | | |
|----------|---|--------------|
| A | SRS airbags | P.34 |
| B | Floor mats | P.26 |
| C | Front seats | P.192 |
| D | Rear seats | P.193 |
| E | Head restraints | P.196 |
| F | Seat belts | P.29 |
| G | Inside lock buttons | P.170 |
| H | Assist grips | P.438 |
| I | Coat hooks | P.437 |
| J | Cup holders | P.419 |
| K | Console box | P.419 |
| L | Rear seat heater switches *..... | P.412 |

* : If equipped

■ Ceiling

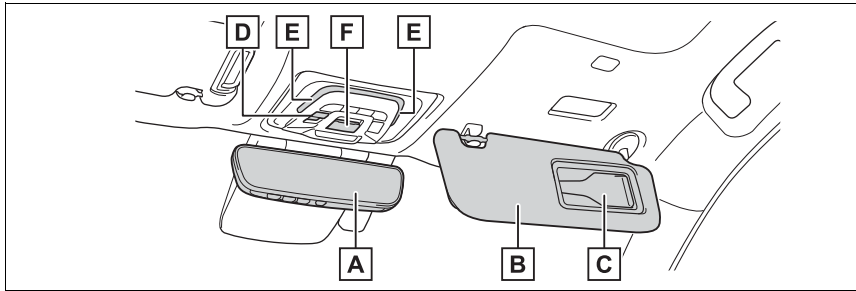

| | | |
|----------|--|-------|
| A | Inside rear view mirror ^{*1} | P.200 |
| | Digital Rear-view Mirror ^{*1} | P.201 |
| | Garage door opener switches ^{*1} | P.439 |
| B | Sun visors | P.428 |
| C | Vanity mirrors | P.428 |
| D | Electronic sunshade switches ^{*1} | P.426 |
| E | Interior lights ^{*2} | P.416 |
| | Personal lights | P.417 |
| F | “SOS” button | P.64 |

^{*1}: If equipped

^{*2}: The illustration shows the front, but they are also equipped in the rear.

For safety and security

1

25

1-1. For safe use

Before driving 26

For safe driving 27

Seat belts 29

SRS airbags 34

Front passenger occupant
classification system 44

1-2. Child safety

Riding with children 49

Child restraint systems... 50

1-3. Emergency assistance

Safety Connect 64

1-4. Theft deterrent system

Immobilizer system 68

Alarm..... 69

1

For safety and security

Before driving

Observe the following before starting off in the vehicle to ensure safety of driving.

Installing floor mats

Use only floor mats designed specifically for vehicles of the same model and model year as your vehicle. Fix them securely in place onto the carpet.

- 1 Insert the retaining hooks (clips) into the floor mat eye-lets.

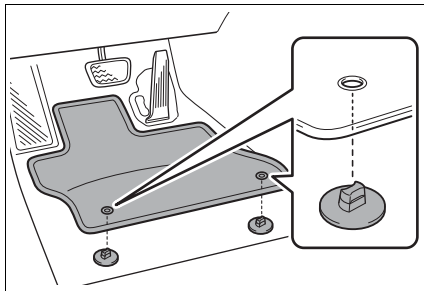

- 2 Turn the upper knob of each retaining hook (clip) to secure the floor mats in place.

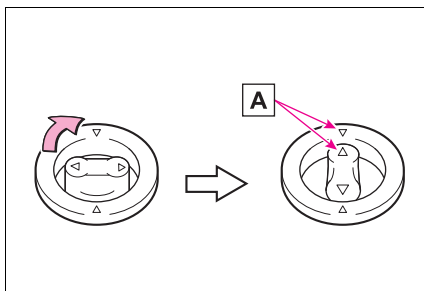

Always align the \triangle marks **A**.

The shape of the retaining hooks (clips) may differ from that shown in the illustration.

WARNING

Observe the following precautions. Failure to do so may cause the driver's floor mat to slip, possibly interfering with the pedals while driving. An unexpectedly high speed may result or it may become difficult to stop the vehicle. This could lead to an accident, resulting in death or serious injury.

When installing the driver's floor mat

- Do not use floor mats designed for other models or different model year vehicles, even if they are Toyota Genuine floor mats.
- Only use floor mats designed for the driver's seat.
- Always install the floor mat securely using the retaining hooks (clips) provided.
- Do not use two or more floor mats on top of each other.
- Do not place the floor mat bottom-side up or upside-down.

⚠ WARNING**■ Before driving**

- Check that the floor mat is securely fixed in the correct place with all the provided retaining hooks (clips). Be especially careful to perform this check after cleaning the floor.

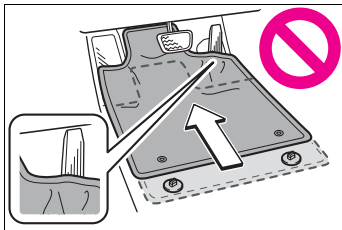

- With the EV system stopped and the shift position in P, fully depress each pedal to the floor to make sure it does not interfere with the floor mat.

For safe driving

For safe driving, adjust the seat and mirror to an appropriate position before driving.

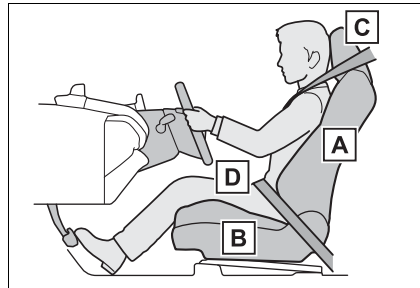
Correct driving posture

- A** Adjust the angle of the seat-back so that you are sitting straight up and so that you do not have to lean forward to steer. (→P.192)
- B** Adjust the seat so that you can depress the pedals fully and so that your arms bend slightly at the elbow when gripping the steering wheel. (→P.192)
- C** Lock the head restraint in place with the center of the head restraint closest to the top of your ears. (→P.196)
- D** Wear the seat belt correctly. (→P.30)

1

For safety and security

**WARNING**

Observe the following precautions.

Failure to do so may result in death or serious injury.

- Do not adjust the position of the driver's seat while driving. Doing so could cause the driver to lose control of the vehicle.
- Do not place a cushion between the driver or passenger and the seatback. A cushion may prevent correct posture from being achieved, and reduce the effectiveness of the seat belt and head restraint.
- Do not place anything under the front seats. Objects placed under the front seats may become jammed in the seat tracks and stop the seat from locking in place. This may lead to an accident and the adjustment mechanism may also be damaged.
- Always observe the legal speed limit when driving on public roads.
- When driving over long distances, take regular breaks before you start to feel tired. Also, if you feel tired or sleepy while driving, do not force yourself to continue driving and take a break immediately.

Correct use of the seat belts

Make sure that all occupants are wearing their seat belts before driving the vehicle. (→P.30)

Use a child restraint system appropriate for the child until the child becomes large enough to

properly wear the vehicle's seat belt. (→P.50)

Adjusting the mirrors

Make sure that you can see the rear of the vehicle clearly by adjusting the inside rear view mirror (if equipped), Digital Rear-view Mirror (if equipped) and outside rear view mirrors properly. (→P.200, 201, 210)

Seat belts

Make sure that all occupants are wearing their seat belts before driving the vehicle.

WARNING

Observe the following precautions to reduce the risk of injury in the event of sudden braking, sudden swerving or an accident. Failure to do so may cause death or serious injury.

■ Wearing a seat belt

- Ensure that all passengers wear a seat belt.
- Always wear a seat belt properly.
- Each seat belt should be used by one person only. Do not use a seat belt for more than one person at once, including children.
- Toyota recommends that children be seated in the rear seat and always use a seat belt and/or an appropriate child restraint system.
- To achieve a proper seating position, do not recline the seat more than necessary. The seat belt is most effective when the occupants are sitting up straight and well back in the seats.
- Do not wear the shoulder belt under your arm.
- Always wear your seat belt low and snug across your hips.

■ Pregnant women

Obtain medical advice and wear the seat belt in the proper way. (→P.30)

Women who are pregnant should position the lap belt as low as possible over the hips in the same manner as other occupants, extending the shoulder belt completely over the shoulder and avoiding belt contact with the rounding of the abdominal area.

If the seat belt is not worn properly, not only the pregnant woman, but also the fetus could suffer death or serious injury as a result of sudden braking or a collision.

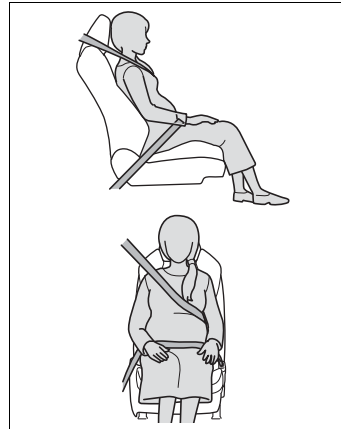

■ People suffering illness

Obtain medical advice and wear the seat belt in the proper way. (→P.30)

■ When children are in the vehicle

→P.58

■ Seat belt damage and wear

- Do not damage the seat belts by allowing the belt, plate, or buckle to be jammed in the door.

⚠ WARNING

- Inspect the seat belt system periodically. Check for cuts, fraying, and loose parts. Do not use a damaged seat belt until it is replaced. Damaged seat belts cannot protect an occupant from death or serious injury.
- Ensure that the belt and plate are locked and the belt is not twisted.
If the seat belt does not function correctly, immediately contact your Toyota dealer.
- Replace the seat assembly, including the belts, if your vehicle has been involved in a serious accident, even if there is no obvious damage.
- Do not attempt to install, remove, modify, disassemble or dispose of the seat belts. Have any necessary repairs carried out by your Toyota dealer. Inappropriate handling may lead to incorrect operation.

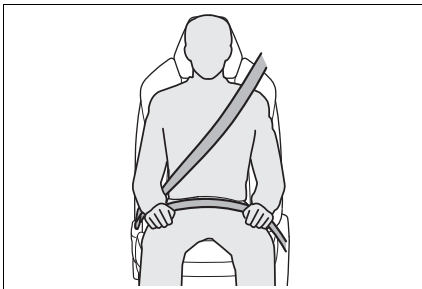
Correct use of the seat belts

- Extend the shoulder belt so that it comes fully over the shoulder, but does not come into contact with the neck or slide off the shoulder.

- Position the lap belt as low as possible over the hips.
- Adjust the position of the seatback.
Sit up straight and well back in the seat.
- Do not twist the seat belt.

■ Child seat belt usage

The seat belts of your vehicle were principally designed for persons of adult size.

- Use a child restraint system appropriate for the child, until the child becomes large enough to properly wear the vehicle's seat belt. (→P.50)
- When the child becomes large enough to properly wear the vehicle's seat belt, follow the instructions regarding seat belt usage. (→P.29)

■ Seat belt extender

If your seat belts cannot be fastened securely because they are not long enough, a personalized seat belt extender is available from your Toyota dealer free of charge.

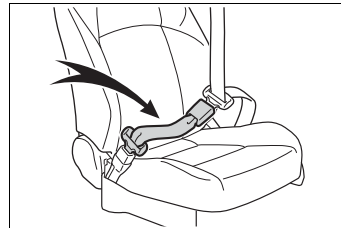
**⚠ WARNING****■ Using a seat belt extender**

Observe the following precautions to reduce the risk of injury in the event of sudden braking, sudden swerving or an accident. Failure to do so may cause death or serious injury.

⚠ WARNING

- Do not wear the seat belt extender if you can fasten the seat belt without the extender.
- Do not use the seat belt extender when installing a child restraint system because the belt will not securely hold the child restraint system, increasing the risk of death or serious injury in the event of an accident.
- The personalized extender may not be safe on another vehicle, when used by another person, or at a different seating position other than the one originally intended.

⚠ NOTICE**■ When using a seat belt extender**

When releasing the seat belt, press on the buckle release button on the extender, not on the seat belt.
This helps prevent damage to the vehicle interior and the extender itself.

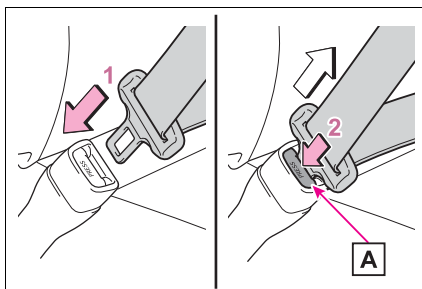
Fastening and releasing the seat belt

- 1 To fasten the seat belt, push the plate into the buckle until

a click sound is heard.

- 2 To release the seat belt, press the release button **A**.

■ Emergency locking retractor (ELR)

The retractor will lock the belt during a sudden stop or on impact. It may also lock if you lean forward too quickly. A slow, easy motion will allow the belt to extend so that you can move around fully.

■ Automatic locking retractor (ALR)

When a passenger's shoulder belt is completely extended and then retracted even slightly, the belt is locked in that position and cannot be extended. This feature is used to hold a child restraint system (CRS) firmly. To free the belt again, fully retract the belt and then pull the belt out once more.

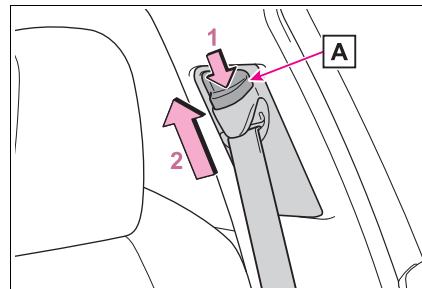
Adjusting the seat belt shoulder anchor height (front seats)

- 1 Push the seat belt shoulder anchor down while pressing the release button **A**.
- 2 Push the seat belt shoulder anchor up.

Move the height adjuster up and

down as needed until you hear a click.

⚠ WARNING

■ **Adjustable shoulder anchor**

Always make sure the shoulder belt is positioned across the center of your shoulder. The belt should be kept away from your neck, but not falling off your shoulder. Failure to do so could reduce the amount of protection in an accident and cause death or serious injuries in the event of a sudden stop, sudden swerve or accident.

Seat belt pretensioners (front and outboard rear seats)

The pretensioners help the seat belts to quickly restrain the occupants by retracting the seat belts when the vehicle is subjected to certain types of severe frontal collision or a vehicle roll-over.

The front seat belt pretensioners also activate when the vehicle is subjected to certain types of severe side collision.

The pretensioners do not activate in the event of a minor frontal impact, a minor side impact or a rear impact.

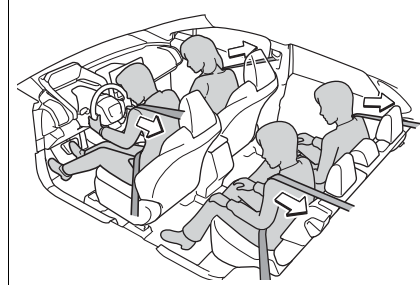

■ **Replacing the belt after the pretensioner has been activated**

If the vehicle is involved in multiple collisions, the pretensioner will activate for the first collision, but will not activate for the second or subsequent collisions.

■ **PCS-linked seat belt pretensioner control**

If the PCS (Pre-Collision System) determines that the possibility of a collision with a vehicle is high, the seat belt pretensioners will be prepared to operate.

⚠ WARNING

■ **Seat belt pretensioners**

Observe the following precautions to reduce the risk of injury in the event of sudden braking, sudden swerving or an accident. Failure to do so may cause death or serious injury.

- Do not place anything, such as a cushion, on the front passenger's seat. Doing so will disperse the passenger's weight, which prevents the sensor from detecting the passenger's weight properly. As a result, the seat belt pretensioner for the front passenger's seat may not activate in the event of a collision.



WARNING

- If the pretensioner has activated, the SRS warning light will come on. In that case, the seat belt cannot be used again and must be replaced at your Toyota dealer.

SRS airbags

The SRS airbags inflate when the vehicle is subjected to certain types of severe impacts that may cause significant injury to the occupants. They work together with the seat belts to help reduce the risk of death or serious injury.

SRS airbag system

■ Location of the SRS airbags

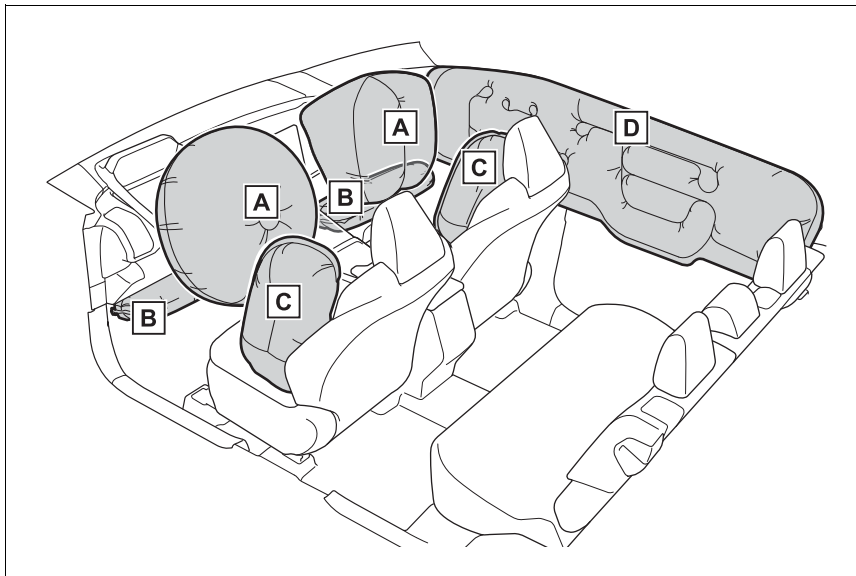

► SRS front airbags

A SRS driver airbag/front passenger airbag

Can help protect the head and chest of the driver and front passenger from impact with interior components

B SRS knee airbags

Can help provide driver and front passenger protection

► SRS side and curtain shield airbags

C SRS front side airbags

Can help protect the torso of the front seat occupants

D SRS curtain shield airbags

- Can help protect primarily the head of occupants in the outboard seats

- Can help prevent the occupants from being thrown from the vehicle in the event of vehicle rollover

■ SRS airbag system components

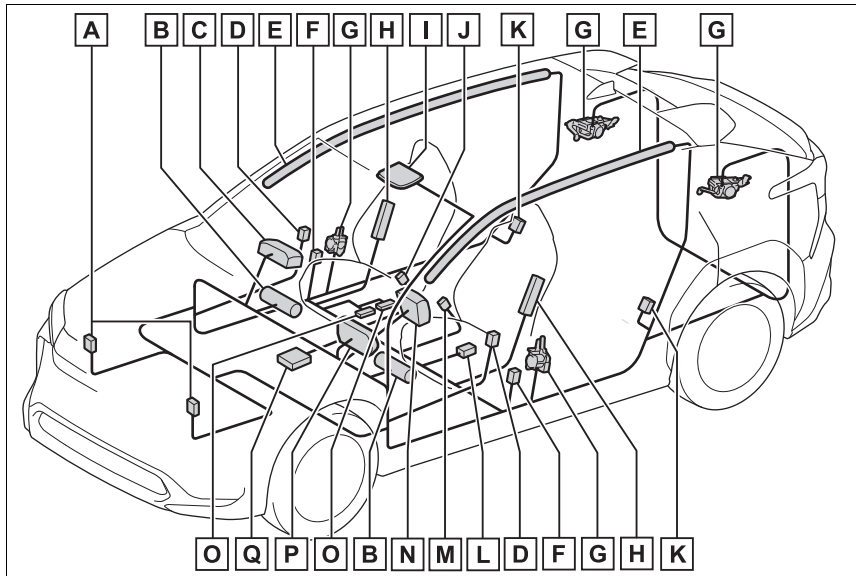

- A** Front impact sensors
- B** Knee airbag
- C** Front passenger airbag
- D** Side impact sensors (front door)
- E** Curtain shield airbags
- F** Side impact sensors (front)
- G** Seat belt pretensioners and force limiters
- H** Side airbags
- I** “AIR BAG ON” and “AIR BAG OFF” indicator lights
- J** Front passenger’s seat belt buckle switch
- K** Side impact sensors (rear)
- L** Driver’s seat position sensor
- M** Driver’s seat belt buckle switch
- N** Driver airbag

O Front passenger occupant classification sensors

P SRS warning light

Q Airbag sensor assembly

Your vehicle is equipped with ADVANCED AIRBAGS designed based on the US motor vehicle safety standards (FMVSS208). The airbag sensor assembly (ECU) controls airbag deployment based on information obtained from the sensors etc. shown in the system components diagram above. This information includes crash severity and occupant information. As the airbags deploy, a chemical reaction in the inflators quickly fills the airbags with non-toxic gas to help restrain the motion of the occupants.

■ If the SRS airbags deploy (inflate)

- Slight abrasions, burns, bruising etc., may be sustained from SRS airbags, due to the extremely high speed deployment (inflation) by hot gases.
- A loud noise and white powder will be emitted.
- Parts of the airbag module (steering wheel hub, airbag cover and inflator) as well as the front seats, parts of the front and rear pillars, and roof side rails, may be hot for several minutes. The airbag itself may also be hot.
- The windshield may crack.
- The EV system will be stopped. (→P.80)
- All of the doors will be unlocked. (→P.168)
- The brakes and stop lights will be controlled automatically. (→P.388)
- The interior lights will turn on automatically. (→P.416)
- The emergency flashers will turn on automatically. (→P.504)
- For Safety Connect subscribers, if any of the following situations occur, the system is designed to send an emergency call to the response center, notifying them of

the vehicle's location (without needing to push the "SOS" button) and an agent will attempt to speak with the occupants to ascertain the level of emergency and assistance required. If the occupants are unable to communicate, the agent automatically treats the call as an emergency and helps to dispatch the necessary emergency services. (→P.64)

- An SRS airbag is deployed.
- A seat belt pretensioner is activated.
- The vehicle is involved in a severe rear-end collision.

■ SRS airbag deployment conditions (SRS front airbags)

- The SRS front airbags will deploy in the event of an impact that exceeds the set threshold level (the level of force corresponding to an approximately 12 - 18 mph [20 - 30 km/h] frontal collision with a fixed wall that does not move or deform).

However, this threshold velocity will be considerably higher in the following situations:

- If the vehicle strikes an object, such as a parked vehicle or sign pole, which can move or deform on impact
- If the vehicle is involved in an underride collision, such as a colli-

sion in which the front of the vehicle underrides, or goes under, the bed of a truck

- Depending on the type of collision, it is possible that only the seat belt pretensioners will activate.
- The SRS front airbags for the front passenger will not activate if there is no passenger sitting in the front passenger seat. However, the SRS front airbags for the front passenger may deploy if luggage is put in the seat, even if the seat is unoccupied.

■ SRS airbag deployment conditions (SRS side and curtain shield airbags)

- The SRS side and curtain shield airbags will deploy in the event of an impact that exceeds the set threshold level (the level of force corresponding to the impact force produced by an approximately 3300 lb. [1500 kg] vehicle colliding with the vehicle cabin from a direction perpendicular to the vehicle orientation at an approximate speed of 12 - 18 mph [20 - 30 km/h]).
- Both SRS curtain shield airbags will deploy in the event of a side collision on either side.
- Both SRS curtain shield airbags will deploy in the event of vehicle rollover.
- Both SRS curtain shield airbags may also deploy in the event of a severe frontal collision.

■ Conditions under which the SRS airbags may deploy (inflate), other than a collision

The SRS front airbags and SRS curtain shield airbags may also deploy if a serious impact occurs to the underside of your vehicle. Some examples are shown in the illustration.

- Hitting a curb, edge of pavement or hard surface

- Falling into or jumping over a deep hole
- Landing hard or falling

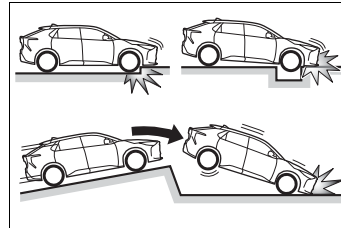

The SRS curtain shield airbags may also deploy under the situations shown in the illustration.

- The angle of vehicle tip-up is marginal.
- The vehicle skids and hits a curb stone.

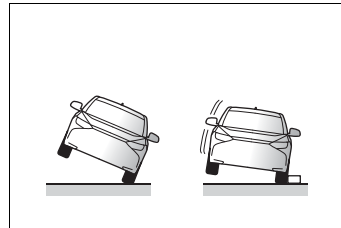

■ Types of collisions that may not deploy the SRS airbags (SRS front airbags)

The SRS front airbags do not generally inflate if the vehicle is involved in a side or rear collision, if it rolls over, or if it is involved in a low-speed frontal collision. But, whenever a collision of any type causes sufficient forward deceleration of the vehicle, deployment of the SRS front airbags may occur.

- Collision from the side
- Collision from the rear
- Vehicle rollover

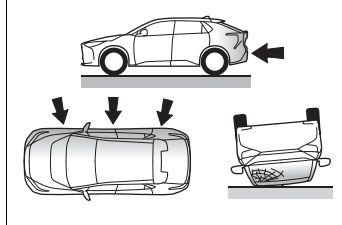

■ **Types of collisions that may not deploy the SRS airbags (SRS side and curtain shield airbags)**

The SRS side and curtain shield airbags may not activate if the vehicle is subjected to a collision from the side at certain angles, or a collision to the side of the vehicle body other than the passenger compartment.

- Collision from the side to the vehicle body other than the passenger compartment
- Collision from the side at an angle

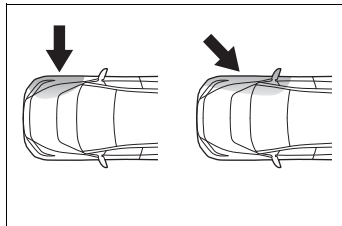

The SRS side airbags do not generally inflate if the vehicle is involved in a frontal or rear collision, if it rolls over, or if it is involved in a low-speed side collision.

- Collision from the front
- Collision from the rear
- Vehicle rollover

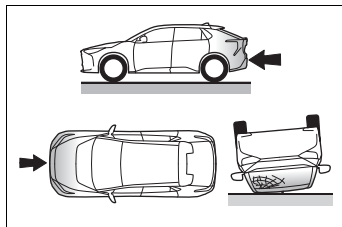

The SRS curtain shield airbags do not generally inflate if the vehicle is

involved in a rear collision, if it pitches end over end, or if it is involved in a low-speed side or low-speed frontal collision.

- Collision from the rear
- Pitching end over end

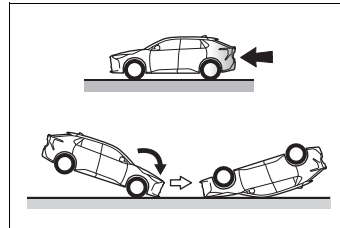

■ **When to contact your Toyota dealer**

In the following cases, the vehicle will require inspection and/or repair. Contact your Toyota dealer as soon as possible.

- Any of the SRS airbags have been inflated.
- The front of the vehicle is damaged or deformed, or was involved in an accident that was not severe enough to cause the SRS front airbags to inflate.

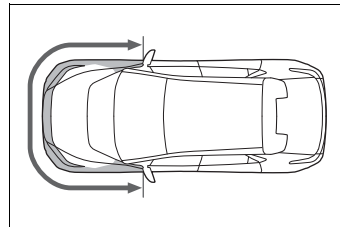

- A portion of a door or its surrounding area is damaged, deformed or has had a hole made in it, or the vehicle was involved in an accident that was not severe enough to cause the SRS side and curtain shield airbags to inflate.

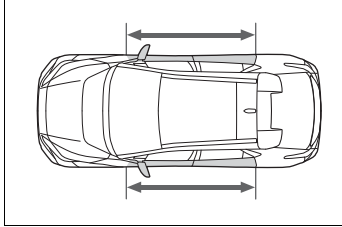

- The pad section of the steering wheel, dashboard near the front passenger airbag or lower portion of the instrument panel is scratched, cracked, or otherwise damaged.

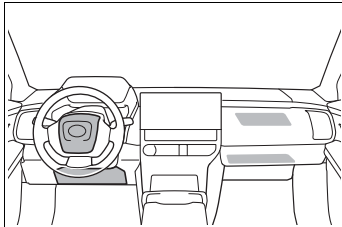

- The surface of the seats with the SRS side airbag is scratched, cracked, or otherwise damaged.

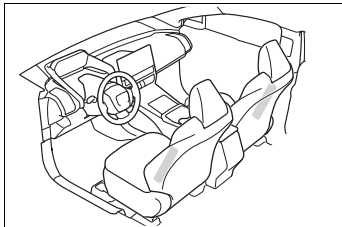

- The portion of the front pillars, rear pillars or roof side rail garnishes (padding) containing the SRS curtain shield airbags inside, is scratched, cracked, or otherwise damaged.

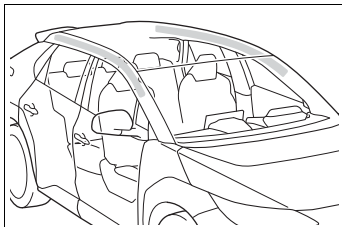

WARNING

■ SRS airbag precautions

Observe the following precautions regarding the SRS airbags. Failure to do so may cause death or serious injury.

- The driver and all passengers in the vehicle must wear their seat belts properly. The SRS airbags are supplemental devices to be used with the seat belts.
- The SRS driver airbag deploys with considerable force, and can cause death or serious injury especially if the driver is very close to the airbag. The National Highway Traffic Safety Administration (NHTSA) advises:

Since the risk zone for the driver's airbag is the first 2 - 3 in. (50 - 75 mm) of inflation, placing yourself 10 in. (250 mm) from your driver airbag provides you with a clear margin of safety. This distance is measured from the center of the steering wheel to your breastbone. If you sit less than 10 in. (250 mm) away now, you can change your driving position in several ways:

- Move your seat to the rear as far as you can while still reaching the pedals comfortably.

⚠ WARNING

- Slightly recline the back of the seat.
Although vehicle designs vary, many drivers can achieve the 10 in. (250 mm) distance, even with the driver seat all the way forward, simply by reclining the back of the seat somewhat. If reclining the back of your seat makes it hard to see the road, raise yourself by using a firm, non-slippery cushion, or raise the seat if your vehicle has that feature.
- If your steering wheel is adjustable, tilt it downward. This points the airbag toward your chest instead of your head and neck.

The seat should be adjusted as recommended by NHTSA above, while still maintaining control of the foot pedals, steering wheel, and your view of the instrument panel controls.

- If the seat belt extender has been connected to the front seat belt buckles but the seat belt extender has not also been fastened to the latch plate of the seat belt, the SRS front airbags will judge that the driver and front passenger are wearing the seat belt even though the seat belt has not been connected. In this case, the SRS front airbags may not activate correctly in a collision, resulting in death or serious injury in the event of a collision. Be sure to wear the seat belt with the seat belt extender.

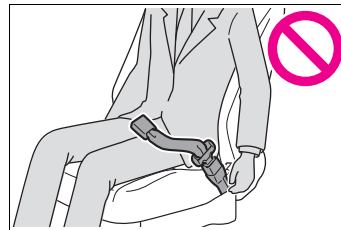

- The SRS front passenger airbag also deploys with considerable force, and can cause death or serious injury especially if the front passenger is very close to the airbag. The front passenger seat should be as far from the airbag as possible with the seat-back adjusted, so the front passenger sits upright.
- Improperly seated and/or restrained infants and children can be killed or seriously injured by a deploying airbag. An infant or child who is too small to use a seat belt should be properly secured using a child restraint system. Toyota strongly recommends that all infants and children be placed in the rear seats of the vehicle and properly restrained. The rear seats are safer for infants and children than the front passenger seat. (→P.50)

⚠ WARNING

- Do not sit on the edge of the seat or lean against the dashboard.

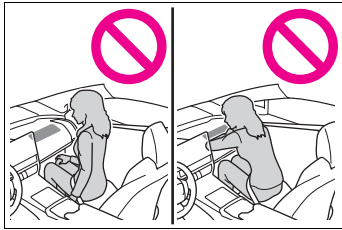

- Do not allow a child to stand in front of the SRS front passenger airbag unit or sit on the knees of a front passenger.

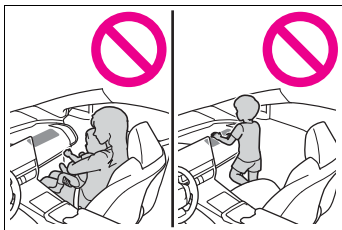

- Do not allow the front seat occupants to hold items on their knees.

- Do not lean against the door, the roof side rail or the front, side and rear pillars.



- Do not allow anyone to kneel on the passenger seat toward the door or put their head or hands outside the vehicle.

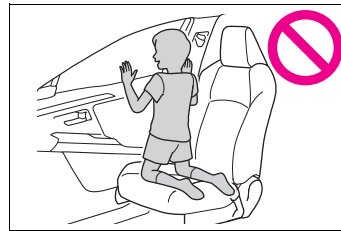

- Do not attach anything to or lean anything against areas such as the dashboard, steering wheel pad and lower portion of the instrument panel. These items can become projectiles when the SRS driver, front passenger and knee airbags deploy.

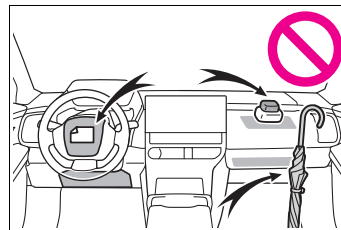

- Do not attach anything to areas such as a door, windshield, side window, front or rear pillar, roof side rail and assist grip.

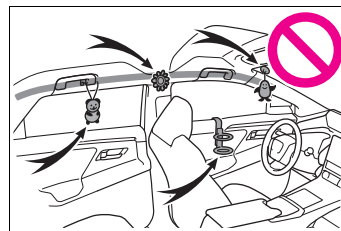

**WARNING**

- Do not hang coat hangers or other hard objects on the coat hooks. All of these items could become projectiles and may cause death or serious injury, should the SRS curtain shield airbags deploy.
- If a vinyl cover is put on the area where the SRS knee airbag will deploy, be sure to remove it.
- Do not use seat accessories which cover the parts where the SRS side airbags inflate as they may interfere with inflation of the SRS airbags. Such accessories may prevent the SRS side airbags from activating correctly, disable the system or cause the SRS side airbags to inflate accidentally, resulting in death or serious injury.
- Do not strike or apply significant levels of force to the area of the SRS airbag components or the front doors.
Doing so can cause the SRS airbags to malfunction.
- Do not touch any of the component parts immediately after the SRS airbags have deployed (inflated) as they may be hot.
- If breathing becomes difficult after the SRS airbags have deployed, open a door or window to allow fresh air in, or leave the vehicle if it is safe to do so. Wash off any residue as soon as possible to prevent skin irritation.
- If the areas where the SRS airbags are stored, such as the steering wheel pad and front and rear pillar garnishes, are damaged or cracked, have them replaced by your Toyota dealer.

- Do not place anything, such as a cushion, on the front passenger's seat. Doing so will disperse the passenger's weight, which prevents the sensor from detecting the passenger's weight properly. As a result, the SRS front airbags for the front passenger may not deploy in the event of a collision.

Modification and disposal of SRS airbag system components

Do not dispose of your vehicle or perform any of the following modifications without consulting your Toyota dealer. The SRS airbags may malfunction or deploy (inflate) accidentally, causing death or serious injury.

- Installation, removal, disassembly and repair of the SRS airbags
- Repairs, modifications, removal or replacement of the steering wheel, instrument panel, dashboard, seats or seat upholstery, front, side and rear pillars, roof side rails, front door panels, front door trims or front door speakers
- Modifications to the front door panel (such as making a hole in it)
- Repairs or modifications of the front fender, front bumper, or side of the occupant compartment
- Installation of a grille guard (bull bars, kangaroo bar, etc.), snow plows, winches or roof luggage carrier
- Modifications to the vehicle's suspension system

 **WARNING**

- Installation of electronic devices such as mobile two-way radios and CD players
- Modifications to your vehicle for a person with a physical disability

Front passenger occupant classification system

Your vehicle is equipped with a front passenger occupant classification system. This system detects the conditions of the front passenger seat and activates or deactivates the front passenger airbag and front passenger knee airbag.

System components

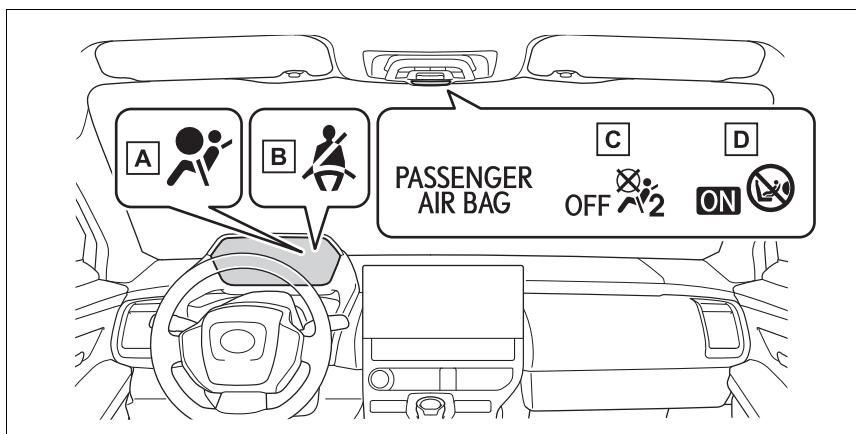

- A** SRS warning light
- B** Driver's and front passenger's seat belt reminder light
- C** "AIR BAG OFF" indicator light
- D** "AIR BAG ON" indicator light

⚠ WARNING

■ Front passenger occupant classification system precautions

Observe the following precautions regarding the front passenger occupant classification system. Failure to do so may cause death or serious injury.

- Wear the seat belt properly.

- Make sure the front passenger's seat belt plate has not been left inserted into the buckle before someone sits in the front passenger seat.

**WARNING**

- Make sure the “AIR BAG OFF” indicator light is not illuminated when using the seat belt extender for the front passenger seat. If the “AIR BAG OFF” indicator light is illuminated, disconnect the extender tongue from the seat belt buckle, and reconnect the seat belt. Reconnect the seat belt extender after making sure the “AIR BAG ON” indicator light is illuminated. If you use the seat belt extender while the “AIR BAG OFF” indicator light is illuminated, the SRS airbags for the front passenger will not activate, which could cause death or serious injury in the event of a collision.
 - Do not apply a heavy load to the front passenger seat or equipment (e.g. seatback pocket).
 - Do not put weight on the front passenger seat by putting your hands or feet on the front passenger seat seatback from the rear passenger seat.
 - Do not let a rear passenger lift the front passenger seat with their feet or press on the seatback with their legs.
 - Do not put objects under the front passenger seat.
- Do not recline the front passenger seatback so far that it touches a rear seat. This may cause the “AIR BAG OFF” indicator light to be illuminated, which indicates that the SRS airbags for the front passenger will not activate in the event of a severe accident. If the seatback touches the rear seat, return the seatback to a position where it does not touch the rear seat. Keep the front passenger seatback as upright as possible when the vehicle is moving. Reclining the seatback excessively may lessen the effectiveness of the seat belt system.
 - If an adult sits in the front passenger seat, the “AIR BAG ON” indicator light is illuminated. If the “AIR BAG OFF” indicator is illuminated, ask the passenger to sit up straight, well back in the seat, feet on the floor, and with the seat belt worn correctly. If the “AIR BAG OFF” indicator still remains illuminated, either ask the passenger to move to the rear seat, or if that is not possible, move the front passenger seat fully rearward.
 - When it is unavoidable to install a forward-facing child restraint system on the front passenger seat, install the child restraint system on the front passenger seat in the proper order. (→P.52)
 - Do not modify or remove the front seats.

⚠ WARNING

- Do not kick the front passenger seat or subject it to severe impact. Otherwise, the SRS warning light may come on to indicate a malfunction of the front passenger occupant classification system. In this case, contact your Toyota dealer immediately.
- Child restraint systems installed on the rear seat should not contact the front seatbacks.
- Do not use a seat accessory, such as a cushion and seat cover, that covers the seat cushion surface.
- Do not modify or replace the upholstery of the front seat.
- Adjust the front passenger seat so that the head restraint does not touch the ceiling. If the head restraint is left in contact with the ceiling, the system may not detect the front passenger properly, leading to improper operation of the airbags.

Condition and operation in the front passenger occupant classification system

■ **Adult**^{*1}

| | | |
|---------------------------|---|---|
| Indicators/warning lights | “AIR BAG ON” and “AIR BAG OFF” indicator lights | “AIR BAG ON” |
| | SRS warning light | Off |
| | Driver’s and front passenger’s seat belt reminder light | Off ^{*2} or flashing ^{*3} |
| Devices | Front passenger airbag | Activated |
| | Front passenger knee airbag | Activated |

■ Child*4

| | | |
|---------------------------|---|---------------------------------|
| Indicators/warning lights | “AIR BAG ON” and “AIR BAG OFF” indicator lights | “AIR BAG OFF” or “AIR BAG ON”*4 |
| | SRS warning light | Off |
| | Driver’s and front passenger’s seat belt reminder light | Off*2 or flashing*3 |
| Devices | Front passenger airbag | Deactivated or activated*4 |
| | Front passenger knee airbag | Deactivated or activated*4 |

■ Child restraint system with infant*5

| | | |
|---------------------------|---|---------------------|
| Indicators/warning lights | “AIR BAG ON” and “AIR BAG OFF” indicator lights | “AIR BAG OFF” *6 |
| | SRS warning light | Off |
| | Driver’s and front passenger’s seat belt reminder light | Off*2 or flashing*3 |
| Devices | Front passenger airbag | Deactivated |
| | Front passenger knee airbag | |

■ Unoccupied

| | | |
|---------------------------|---|---------------|
| Indicators/warning lights | “AIR BAG ON” and “AIR BAG OFF” indicator lights | “AIR BAG OFF” |
| | SRS warning light | Off |
| | Driver’s and front passenger’s seat belt reminder light | |
| Devices | Front passenger airbag | Deactivated |
| | Front passenger knee airbag | |

■ There is a malfunction in the system

| | | |
|---------------------------|---|---------------|
| Indicators/warning lights | “AIR BAG ON” and “AIR BAG OFF” indicator lights | “AIR BAG OFF” |
| | SRS warning light | On |
| | Driver’s and front passenger’s seat belt reminder light | |
| Devices | Front passenger airbag | Deactivated |
| | Front passenger knee airbag | |

- *1: The system judges a person of adult size as an adult. When a smaller adult sits in the front passenger seat, the system may not recognize him/her as an adult depending on his/her physique and posture.
- *2: In the event the front passenger is wearing a seat belt.
- *3: In the event the front passenger does not wear a seat belt.
- *4: For some children, child in seat, child in booster seat or child in convertible seat, the system may not recognize him/her as a child. Factors which may affect this can be the physique or posture.
- *5: Never install a rear-facing child restraint system on the front passenger seat. A forward-facing child restraint system should only be installed on the front passenger seat when it is unavoidable. (→P.52)
- *6: In case the indicator light is not illuminated, consult this manual on how to install the child restraint system properly. (→P.50)

Riding with children

Observe the following precautions when children are in the vehicle.

Use a child restraint system appropriate for the child, until the child becomes large enough to properly wear the vehicle's seat belt.

- It is recommended that children sit in the rear seats to avoid accidental contact with the steering wheel, wiper switch, etc.
- Use the rear door child-protector lock or the window lock switch to avoid children opening the door while driving or operating the power window accidentally.
(→P.171, 214)
- Do not let small children operate equipment which may catch or pinch body parts, such as the power window, hood, back door, seats, etc.

⚠ WARNING**■ When children are in the vehicle**

Never leave children unattended in the vehicle, and never allow children to have or use the key.

Children may be able to start the vehicle or shift the vehicle into neutral. There is also a danger that children may injure themselves by playing with the side windows or other features of the vehicle. In addition, heat build-up or extremely cold temperatures inside the vehicle can be fatal to children.

1

For safety and security

Child restraint systems

Before installing a child restraint system in the vehicle, there are precautions that need to be observed, different types of child restraint systems, as well as installation methods, etc., written in this manual.

Use a child restraint system when riding with a small child that cannot properly use a seat belt. For the child's safety, install the child restraint system to a rear seat. Be sure to follow the installation method that is in the operation manual enclosed with the restraint system.

Table of contents

- Points to remember: P.50
- Child restraint system: P.52
- When using a child restraint system: P.52
- Child restraint system installation method
 - Fixed with a seat belt: P.54
 - Fixed with a child restraint LATCH anchor: P.59
 - Using an anchor bracket (for top tether strap): P.61

Points to remember

The laws of all 50 states of the U.S.A. as well as Canada now require the use of child restraint systems.

- Prioritize and observe the warnings, as well as the laws and regulations for child restraint systems.
- Use a child restraint system until the child becomes large enough to properly wear the vehicle's seat belt.
- Choose a child restraint system that suits your vehicle and is appropriate to the age and size of the child.

WARNING

■ When a child is riding

Observe the following precautions. Failure to do so may result in death or serious injury.

- For effective protection in automobile accidents and sudden stops, a child must be properly restrained, using a seat belt or child restraint system which is correctly installed. For installation details, refer to the operation manual enclosed with the child restraint system. General installation instructions are provided in this manual.

**WARNING**

- Toyota strongly urges the use of a proper child restraint system that conforms to the weight and size of the child, installed on the rear seat. According to accident statistics, the child is safer when properly restrained in the rear seat than in the front seat.
- Holding a child in your or someone else's arms is not a substitute for a child restraint system. In an accident, the child can be crushed against the windshield or between the holder and the interior of the vehicle.

■ Handling the child restraint system

If the child restraint system is not properly fixed in place, the child or other passengers may be seriously injured or even killed in the event of sudden braking, sudden swerving, or an accident.

- If the vehicle were to receive a strong impact from an accident, etc., it is possible that the child restraint system has damage that is not readily visible. In such cases, do not reuse the restraint system.
- Make sure you have complied with all installation instructions provided with the child restraint system manufacturer and that the system is properly secured.
- Keep the child restraint system properly secured on the seat even if it is not in use. Do not store the child restraint system unsecured in the passenger compartment.
- If it is necessary to detach the child restraint system, remove it from the vehicle or store it securely in the luggage compartment.

Child restraint system

■ **Types of child restraint system installation methods**

Confirm with the operation manual enclosed with the child restraint system about the installation of the child restraint system.

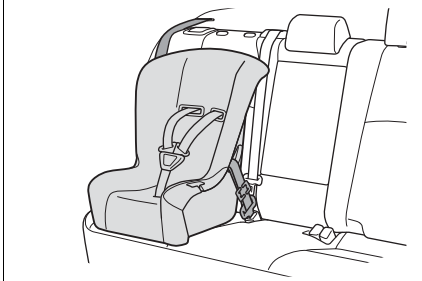
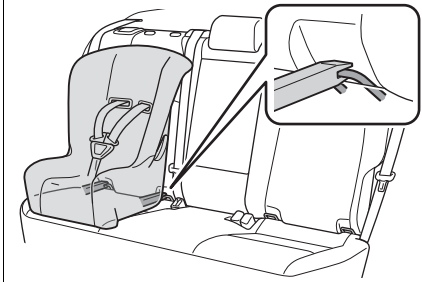
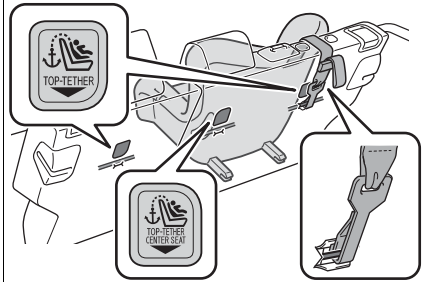
| Installation method | | Page |
|---|--|------|
| Seat belt attachment |  | P.54 |
| Child restraint LATCH anchors attachment |  | P.59 |
| Anchor brackets (for top tether strap) attachment |  | P.61 |

When using a child restraint system

■ **When installing a child restraint system to a front passenger seat**

For the safety of a child, install a child restraint system to a rear seat. When installing the child restraint system to a front passenger seat is unavoidable, adjust the seat as follows and

install the child restraint system.

- Adjust the seatback angle to the most upright position.
- Move the front seat fully rearward. If the passenger seat height can be adjusted, move it to the upper most position.
- If the head restraint interferes with the child restraint system installation and the head restraint can be removed, remove the head restraint. Otherwise, put the head restraint in the upper most position.

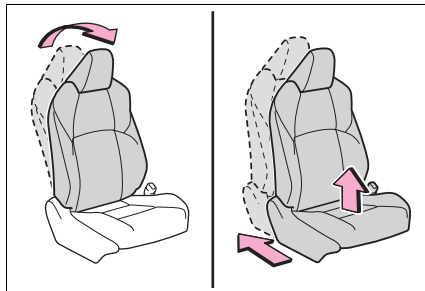

⚠ WARNING

■ **When using a child restraint system**

Observe the following precautions. Failure to do so may result in death or serious injury.

- Never install a rear-facing child restraint system on the front passenger seat even if the “AIR BAG OFF” indicator light is illuminated. In the event of an accident, the force of the rapid inflation of the front passenger airbag can cause death or serious injury to the child if the rear-facing child restraint system is installed on the front passenger seat.
- A forward-facing child restraint system may be installed on the front passenger seat only when it is unavoidable. A child restraint system that requires a top tether strap should not be used in the front passenger seat since there is no top tether strap anchor for the front passenger seat.
- A forward-facing child restraint system may be installed on the front passenger seat only when it is unavoidable. When installing a forward-facing child restraint system on the front passenger seat, adjust the seatback angle to the most upright position, move the seat to the rearmost position, even if the “AIR BAG OFF” indicator light is illuminated. If the head restraint interferes with the child restraint system installation and the head restraint can be removed, remove the head restraint.



⚠ WARNING

- Do not allow the child to lean his/her head or any part of his/her body against the door or the area of the seat, front or rear pillars, or roof side rails from which the SRS side airbags or SRS curtain shield airbags deploy even if the child is seated in the child restraint system. It is dangerous if the SRS side and curtain shield airbags inflate, and the impact could cause death or serious injury to the child.

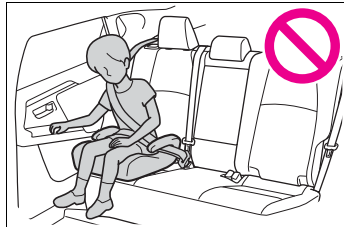

- When a booster seat is installed, always ensure that the shoulder belt is positioned across the center of the child's shoulder. The belt should be kept away from the child's neck, but not so that it could fall off the child's shoulder.
- Use a child restraint system suitable to the age and size of the child and install it to the rear seat.

- If the driver's seat interferes with the child restraint system and prevents it from being attached correctly, attach the child restraint system to the right-hand rear seat.

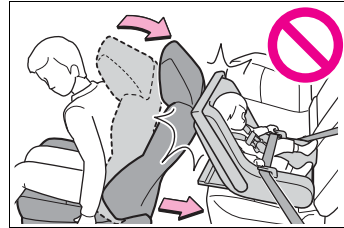

- Adjust the front passenger seat so that it does not interfere with the child restraint system.

Child restraint system fixed with a seat belt

A child restraint system for a small child or baby must itself be properly restrained on the seat with the lap portion of the lap/shoulder belt.

■ Installing child restraint system using a seat belt (child restraint lock function belt)

Install the child restraint system in accordance to the operation manual enclosed with the child restraint system.

■ Rear-facing — Infant seat/convertible seat

- 1 Adjust the rear seat.

If there is a gap between the child restraint system and the seatback, adjust the seatback angle until good contact is achieved.

- Place the child restraint system on the rear seat facing the rear of the vehicle.

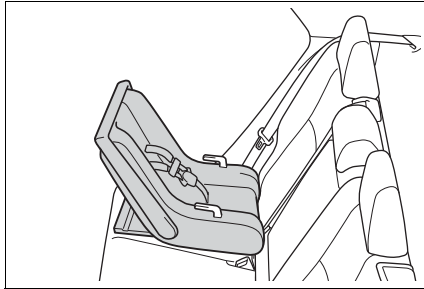

- Run the seat belt through the child restraint system and insert the plate into the buckle. Make sure that the belt is not twisted.

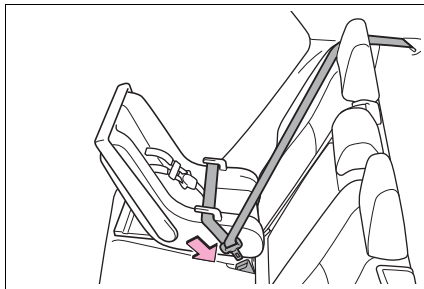

- Fully extend the shoulder belt and allow it to retract to put it in lock mode. In lock mode, the belt cannot be extended.

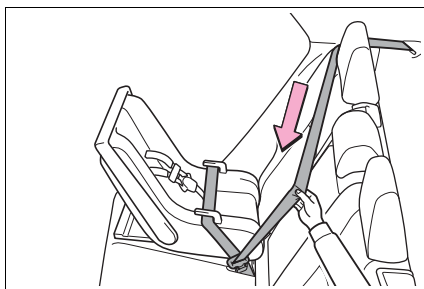

- While pushing the child restraint system down into

the rear seat, allow the shoulder belt to retract until the child restraint system is securely in place.

After the shoulder belt has retracted to a point where there is no slack in the belt, pull the belt to check that it cannot be extended.

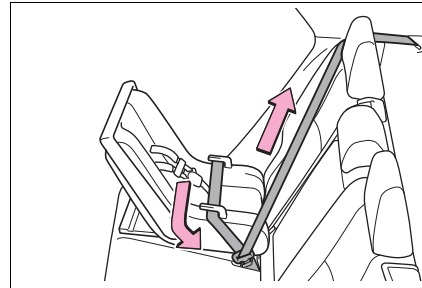

- After installing the child restraint system, rock it back and forth to ensure that it is installed securely. (→P.58)

■ Forward-facing — Convertible seat

- Adjust the seat.

When using the front passenger seat: If installing the child restraint system to the front passenger seat is unavoidable, refer to P.52 for front passenger seat adjustment.

When using the rear seat: If there is a gap between the child restraint system and the seatback, adjust the seatback angle until good contact is achieved.

- If the head restraint interferes with the child restraint system installation and the head restraint can be removed,

remove the head restraint.
(→P.197)

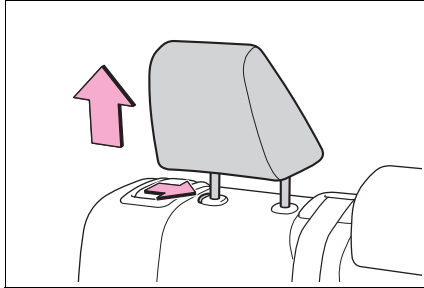

3 Place the child restraint system on the seat facing the front of the vehicle.

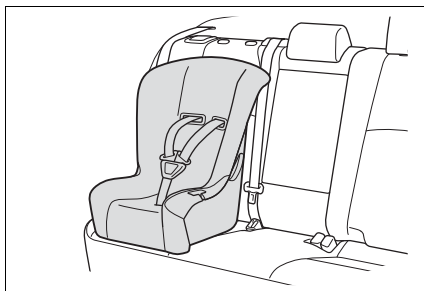

4 Run the seat belt through the child restraint system and insert the plate into the buckle. Make sure that the belt is not twisted.

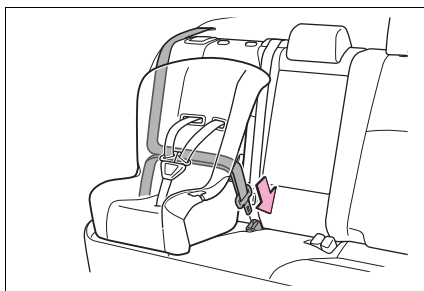

5 Fully extend the shoulder belt and allow it to retract to put it

in lock mode. In lock mode, the belt cannot be extended.

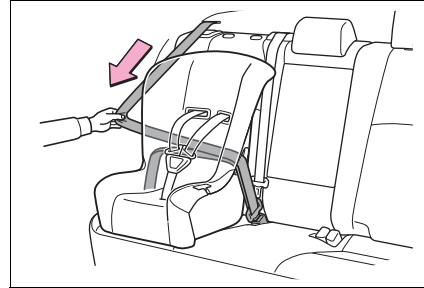

6 While pushing the child restraint system into the rear seat, allow the shoulder belt to retract until the child restraint system is securely in place.

After the shoulder belt has retracted to a point where there is no slack in the belt, pull the belt to check that it cannot be extended.

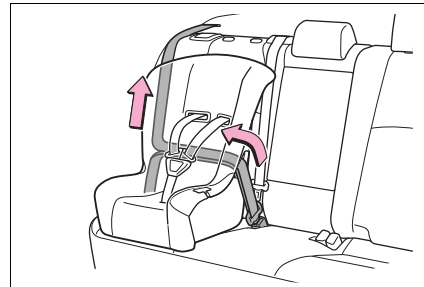

7 If the child restraint has a top tether strap, follow the child restraint manufacturer's operation manual regarding the installation, using the top tether strap to latch onto the top tether strap anchor. (→P.61)

8 After installing the child restraint system, rock it back

and forth to ensure that it is installed securely. (→P.58)

■ Booster seat

- 1 If installing the child restraint system to the front passenger seat is unavoidable, refer to P.52 for front passenger seat adjustment.
- 2 High back type: If the head restraint interferes with your child restraint system, and the head restraint can be removed, remove the head restraint. (→P.197)

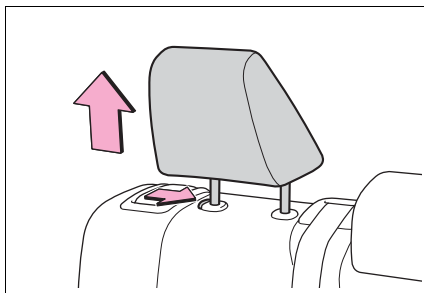

- 3 Place the child restraint system on the seat facing the front of the vehicle.

► Booster type

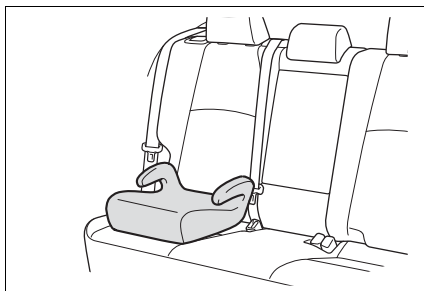

► High back type

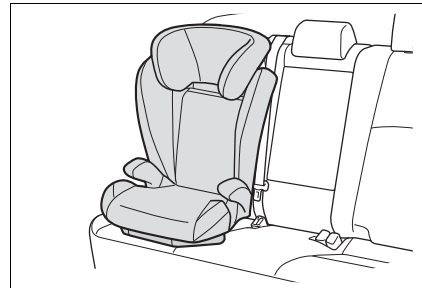

- 4 Sit the child in the child restraint system. Fit the seat belt to the child restraint system according to the manufacturer's instructions and insert the plate into the buckle. Make sure that the belt is not twisted.

Check that the shoulder belt is correctly positioned over the child's shoulder and that the lap belt is as low as possible. (→P.29)



■ Removing a child restraint system installed with a seat belt

Press the buckle release button and fully retract the seat belt.

When releasing the buckle, the child restraint system may spring up due to the rebound of the seat cushion. Release the buckle while holding down the child restraint

system.

Since the seat belt automatically reels itself, slowly return it to the stowing position.

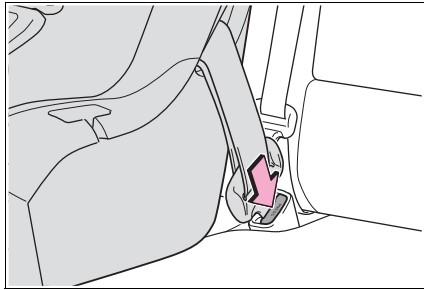

⚠ WARNING

■ **When installing a child restraint system**

Observe the following precautions.

Failure to do so may result in death or serious injury.

- Do not allow children to play with the seat belt. If the seat belt becomes twisted around a child's neck, it may lead to choking or other serious injuries that could result in death. If this occurs and the buckle cannot be unfastened, scissors should be used to cut the belt.
- Ensure that the belt and plate are securely locked and the seat belt is not twisted.
- Shake the child restraint system left and right, and forward and backward to ensure that it has been securely installed.
- After securing a child restraint system, never adjust the seat.

● When a booster seat is installed, always ensure that the shoulder belt is positioned across the center of the child's shoulder. The belt should be kept away from the child's neck, but not so that it could fall off the child's shoulder.

● Follow all installation instructions provided by the child restraint system manufacturer.

● When securing some types of child restraint systems in rear seats, it may not be possible to properly use the seat belts in positions next to the child restraint without interfering with it or affecting seat belt effectiveness. Be sure your seat belt fits snugly across your shoulder and low on your hips. If it does not, or if it interferes with the child restraint, move to a different position. Failure to do so may result in death or serious injury.

● When installing a child restraint system in the rear center seat, adjust both seatbacks at the same angle. Otherwise, the child restraint system cannot be securely restrained and this may cause death or serious injuries in the event of sudden braking, sudden swerving or an accident.

⚠ WARNING**■ When installing a booster seat**

To prevent the belt from going into ALR lock mode, do not fully extend the shoulder belt. ALR mode causes the belt to tighten only. This could cause injury or discomfort to the child. (→P.31)

■ Do not use a seat belt extender

If a seat belt extender is used when installing a child restraint system, the seat belt will not securely hold the child restraint system, which could cause death or serious injury to the child or other passengers in the event of sudden braking, sudden swerving or an accident.

Child restraint system fixed with a child restraint LATCH anchor**■ Child restraint LATCH anchors**

LATCH anchors are provided for the outboard rear seats.

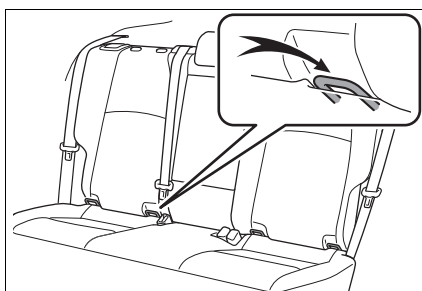
**■ When installing in the rear outboard seats**

Install the child restraint system in accordance to the operation

manual enclosed with the child restraint system.

1 Adjust the seat.

If there is a gap between the child restraint system and the seatback, adjust the seatback angle until good contact is achieved.

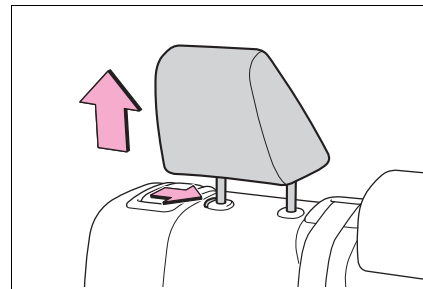
2 If the head restraint interferes with the child restraint system installation and the head restraint can be removed, remove the head restraint. (→P.197)**▶ With flexible lower attachments****3 Latch the hooks of the lower attachments onto the LATCH anchors.**

For owners in Canada:

The symbol on a child restraint system indicates **A**

the presence of a lower connector system.

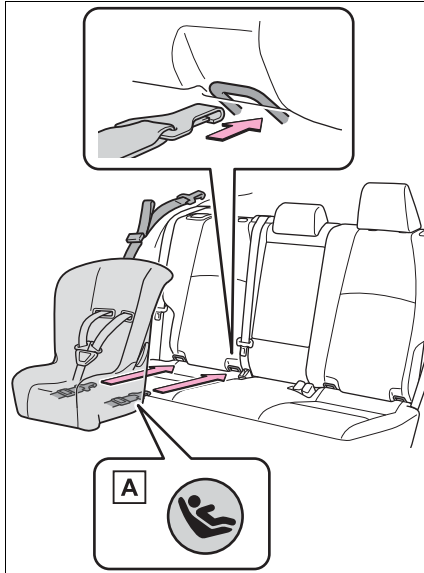

A Canada only

► With rigid lower attachments

- 3 Latch the buckles onto the LATCH anchors.
For owners in Canada:
The symbol on a child restraint system indicates **A**

the presence of a lower connector system.

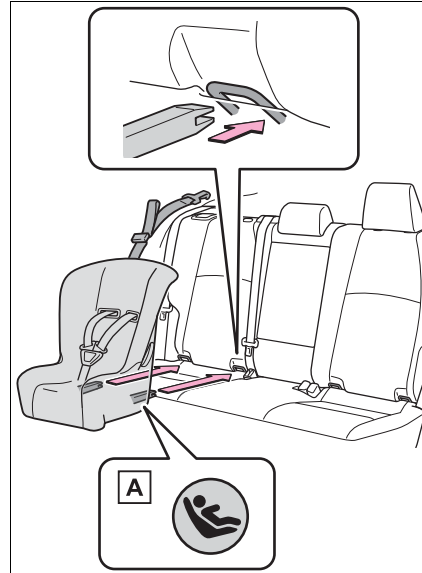

A Canada only

- 4 If the child restraint has a top tether strap, follow the child restraint manufacturer's operation manual regarding the installation, using the top tether strap to latch onto the top tether strap anchor. (→P.61)
- 5 After installing the child restraint system, rock it back and forth to ensure that it is installed securely. (→P.58)

■ Laws and regulations pertaining to anchors

The LATCH system conforms to FMVSS225 or CMVSS210.2. Child restraint systems conforming to FMVSS213 or CMVSS213 specifications can be used. This vehicle is designed to conform to SAE J1819.

⚠ WARNING**■ When installing a child restraint system**

Observe the following precautions.

Failure to do so may result in death or serious injury.

- When using the LATCH anchors, be sure that there are no foreign objects around the anchors and that the seat belt is not caught behind the child restraint system.
- Follow all installation instructions provided by the child restraint system manufacturer.
- Child restraint systems cannot be installed in the rear center seat. Do not install the child restraint system in the rear center seat using the LATCH anchors.
- When securing some types of child restraint systems in rear seats, it may not be possible to properly use the seat belts in positions next to the child restraint without interfering with it or affecting seat belt effectiveness. Be sure your seat belt fits snugly across your shoulder and low on your hips. If it does not, or if it interferes with the child restraint, move to a different position. Failure to do so may result in death or serious injury.
- If the seat is adjusted, reconfirm the security of the child restraint system.

Using an anchor bracket (for top tether strap)**■ Anchor brackets (for top tether strap)**

Anchor brackets are provided for each rear seat.

Use anchor brackets when fixing the top tether strap.

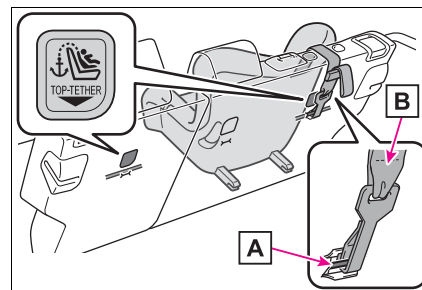
► Outboard rear seats

A Anchor brackets

B Top tether strap

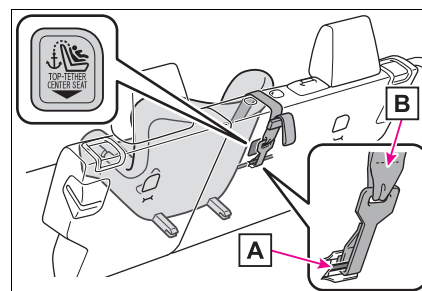
► Rear center seat

A Anchor bracket

B Top tether strap

■ Fixing the top tether strap to the anchor bracket

Install the child restraint system in accordance to the operation

manual enclosed with the child restraint system.

► Outboard rear seats

- 1 Remove the head restraint. (→P.197)

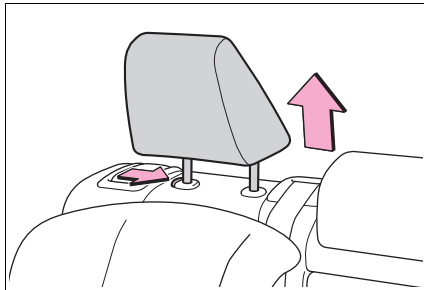

- 2 Latch the hook onto the anchor bracket and tighten the top tether strap.

Make sure the top tether strap is securely latched. (→P.58)

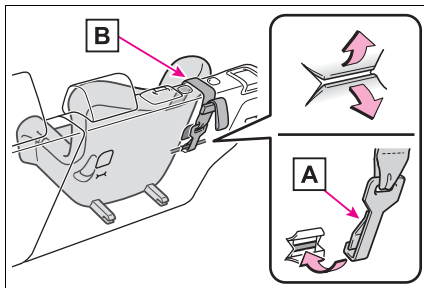

- A** Hook
- B** Top tether strap

- 3 If the head restraint does not interfere with the child

restraint system installation, install the head restraint.

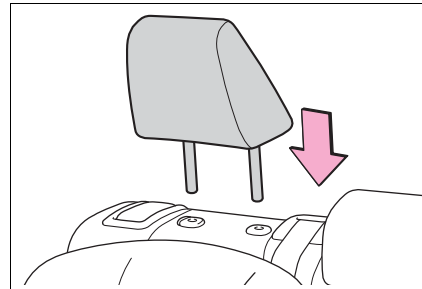

► Rear center seat

- 1 Adjust the head restraint to the upmost position.

If the head restraint interferes with your child restraint system, and the head restraint can be removed, remove the head restraint. (→P.197)

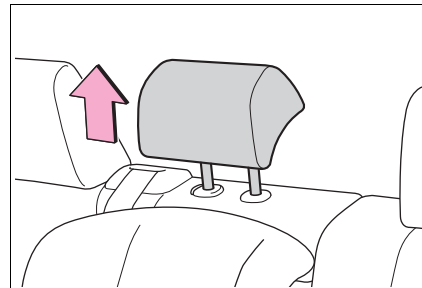

- 2 Latch the hook onto the anchor bracket and tighten the top tether strap.

Make sure the top tether strap is securely latched.

When installing the child restraint system with the head restraint being raised, be sure to have the top tether strap pass underneath the head restraint.

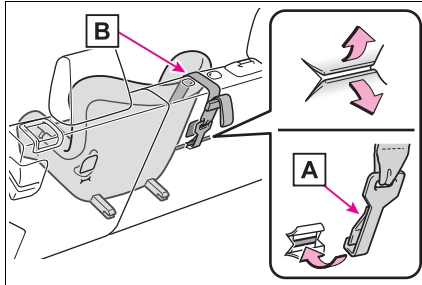

A Hook

B Top tether strap

- Rear center seat: When installing the child restraint system with the head restraint being raised, after the head restraint has been raised and then the anchor bracket has been fixed, do not lower the head restraint.

■ Laws and regulations pertaining to anchors

The LATCH system conforms to FMVSS225 or CMVSS210.2. Child restraint systems conforming to FMVSS213 or CMVSS213 specifications can be used. This vehicle is designed to conform to SAE J1819.

⚠ WARNING

■ When installing a child restraint system

Observe the following precautions.

Failure to do so may result in death or serious injury.

- Firmly attach the top tether strap and make sure that the belt is not twisted.
- Do not attach the top tether strap to anything other than the anchor bracket.
- After securing a child restraint system, never adjust the seat.
- Follow all installation instructions provided by the child restraint system manufacturer.

Safety Connect

Safety Connect is a subscription-based telematics service that uses Global Positioning System (GPS) data and embedded cellular technology to provide safety and security features to subscribers. Safety Connect is supported by Toyota's designated response center, which operates 24 hours per day, 7 days per week.

Safety Connect service is available by subscription on select, telematics hardware-equipped vehicles.

By using the Safety Connect service, you are agreeing to be bound by the Telematics Subscription Service Agreement and its Terms and Conditions, as in effect and amended from time to time, a current copy of which is available at Toyota.com. All use of the Safety Connect service is subject to such then-applicable Terms and Conditions.

System components

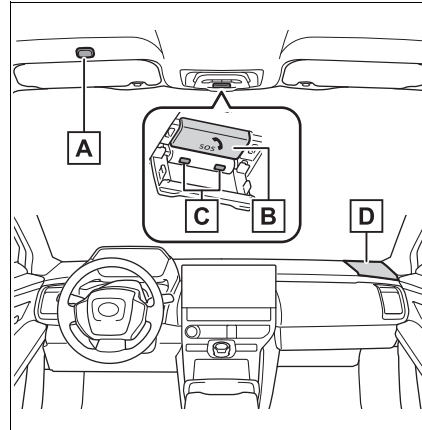

- A** Microphone
- B** "SOS" button
- C** LED light indicators
- D** Speaker

Services

Subscribers have the following Safety Connect services available:

- Automatic Collision Notification*

Helps drivers receive necessary response from emergency service providers. (→P.66)

*: U.S. Patent No. 7,508,298 B2

- Stolen Vehicle Location

Helps drivers in the event of vehicle theft. (→P.66)

- Emergency Assistance Button ("SOS")

Connects drivers to response-cen-

ter support. (→P.66)

- **Enhanced Roadside Assistance**

Provides drivers various on-road assistance. (→P.67)

Subscription

After you have signed the Telematics Subscription Service Agreement and are enrolled, you can begin receiving services.

A variety of subscription terms are available for purchase. Contact your Toyota dealer, call the following or push the “SOS” button in your vehicle for further subscription details.

- **The United States**

1-800-331-4331

- **Canada**

1-888-869-6828



NOTICE

- **Safety Connect Services Information**

- Phone calls using the vehicles Bluetooth® technology will not be possible during Safety Connect.

- Safety Connect is available beginning Fall 2009 on select Toyota models (in the contiguous United States only). Contact with the Safety Connect response center is dependent upon the telematics device being in operative condition, cellular connection availability, and GPS satellite signal reception, which can limit the ability to reach the response center or receive emergency service support. Enrollment and Telematics Subscription Service Agreement are required. A variety of subscription terms are available; charges vary by subscription term selected and location.

- Automatic Collision Notification, Emergency Assistance and Stolen Vehicle Location are available in the United States, including Hawaii and Alaska, as well as and Canada, and Enhanced Roadside Assistance are available in the United States and Canada.

- Automatic Collision Notification, Emergency Assistance, Stolen Vehicle and Enhanced Road Assistance will not function in the United States Virgin Islands. For vehicles first sold in the USVI, no Safety Connect services will function in and outside the United States Virgin Islands.

- Safety Connect services are not subject to section 255 of the Telecommunications Act and the device is not TTY compatible.

- **Languages**

The Safety Connect response center will offer support in multiple languages. The Safety Connect system will offer voice prompts in English, Spanish, and French. Please indicate your language of choice when enrolling.

**NOTICE****■ When contacting the response center**

You may be unable to contact the response center if the network is busy.

Safety Connect LED light Indicators

When the power switch is turned to ON, the red indicator light comes on for 2 seconds then turns off. Afterward, the green indicator light comes on, indicating that the service is active.

The following indicator light patterns indicate specific system usage conditions:

- Green indicator light on = Active service
- Green indicator light flashing = Safety Connect call in process
- Red indicator light (except at vehicle start-up) = System malfunction (contact your Toyota dealer)
- No indicator light (off) = Safety Connect service not active

Safety Connect services**■ Automatic Collision Notification**

In case of either airbag deployment or severe rear-end colli-

sion, the system is designed to automatically call the response center. The responding agent receives the vehicle's location and attempts to speak with the vehicle occupants to assess the level of emergency. If the occupants are unable to communicate, the agent automatically treats the call as an emergency, contacts the nearest emergency services provider to describe the situation, and requests that assistance be sent to the location.

■ Stolen Vehicle Location

If your vehicle is stolen, Safety Connect can work with local authorities to assist them in locating and recovering the vehicle. After filing a police report, call the Customer Experience Center at 1-800-331-4331 in the United States, 1-888-869-6828 in Canada, and follow the prompts for Safety Connect to initiate this service.

In addition to assisting law enforcement with recovery of a stolen vehicle, Safety-Connect-equipped vehicle location data may, under certain circumstances, be shared with third parties to locate your vehicle. Further information is available at Toyota.com.

■ Emergency Assistance Button ("SOS")

In the event of an emergency on

the road, push the “SOS” button to reach the Safety Connect response center. The answering agent will determine your vehicle’s location, assess the emergency, and dispatch the necessary assistance required.

If you accidentally press the “SOS” button, tell the response-center agent that you are not experiencing an emergency.

■ **Enhanced Roadside Assistance**

Enhanced Roadside Assistance adds GPS data to the already included warranty-based Toyota roadside service.

Subscribers can press the “SOS” button to reach a Safety Connect response-center agent, who can help with a wide range of needs, such as: towing, flat tire, fuel delivery, etc. For a description of the Enhanced Roadside Assistance services and their limitations, please see the Safety Connect Terms and Conditions, which are available at Toyota.com.

Safety information for Safety Connect

Important! Read this information about exposure to radio frequency signals before using Safety Connect;

The Safety Connect system installed in your vehicle is a low-

power radio transmitter and receiver. It receives and also sends out radio frequency (RF) signals.

In August 1996, the Federal Communications Commission (FCC) adopted RF exposure guidelines with safety levels for mobile wireless phones. Those guidelines are consistent with the safety standards previously set by the following U.S. and international standards bodies.

- ANSI (American National Standards Institute) C95.1 [1992]
- NCRP (National Council on Radiation Protection and Measurement) Report 86 [1986]
- ICNIRP (International Commission on Non-Ionizing Radiation Protection) [1996]

Those standards were based on comprehensive and periodic evaluations of the relevant scientific literature. Over 120 scientists, engineers, and physicians from universities, and government health agencies and industries reviewed the available body of research to develop the ANSI Standard (C95.1).

The design of Safety Connect complies with the FCC guidelines in addition to those standards.

Immobilizer system

The vehicle's keys have built-in transponder chips that prevent the EV system from starting if a key has not been previously registered in the vehicle's on-board computer.

Never leave the keys inside the vehicle when you leave the vehicle.

This system is designed to help prevent vehicle theft but does not guarantee absolute security against all vehicle thefts.

Operating the system

The indicator light flashes after the power switch has been turned to OFF to indicate that the system is operating.

The indicator light goes off after the power switch has been turned to ACC or ON to indicate that the system has been canceled.

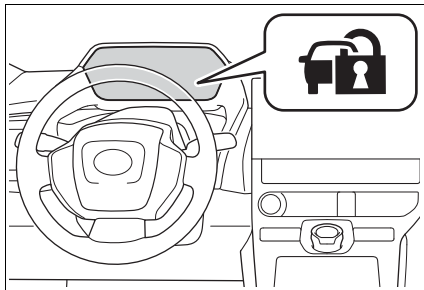

System maintenance

The vehicle has a maintenance-free type immobilizer system.

Conditions that may cause the system to malfunction

- If the grip portion of the key is in contact with a metallic object
- If the key is in close proximity to or touching a key to the security system (key with a built-in transponder chip) of another vehicle

NOTICE

To ensure the system operates correctly

Do not modify or remove the system. If modified or removed, the proper operation of the system cannot be guaranteed.

Alarm

The alarm uses light and sound to give an alert when an intrusion is detected.

The alarm is triggered in the following situations when the alarm is set:

- A locked door is unlocked or opened in any way other than using the entry function or wireless remote control or mechanical key. (The doors will lock again automatically.)
- The hood is opened.

Setting/canceling/stopping the alarm system

■ Items to check before locking the vehicle

To prevent unexpected triggering of the alarm and vehicle theft, make sure of the following:

- Nobody is in the vehicle.
- The side windows are closed before the alarm is set.
- No valuables or other personal items are left in the vehicle.

■ Setting

Close the doors and hood, and lock all the doors. The system will be set automatically after 30 seconds.

The security indicator changes from being on to flashing when the system is set.

The alarm can also be set using the mechanical key.

If all doors are closed with hood open, alarm system can be set.

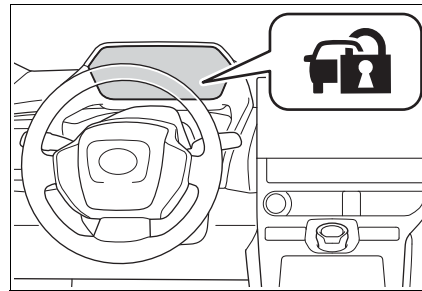

■ Canceling or stopping

Do one of the following to deactivate or stop the alarm:

- Unlock the doors.
- Turn the power switch to ACC or ON, or start the EV system. (The alarm will be deactivated or stopped after a few seconds.)

■ System maintenance

The vehicle has a maintenance-free type alarm system.

■ Triggering of the alarm

The alarm may be triggered in the following situations: (Stopping the alarm deactivates the alarm system.)

If a door is unlocked using the mechanical key while the alarm is set, a warning will sound intermittently for approximately 10 seconds.

If the alarm is not canceled or stopped during this time, the warning pattern changes and the warning sounds for a certain period of time.

70 1-4. Theft deterrent system

- A person inside the vehicle opens a door or hood, or unlocks the vehicle using an inside lock button.



- The 12-volt battery is recharged or replaced when the vehicle is locked. (→P.543)

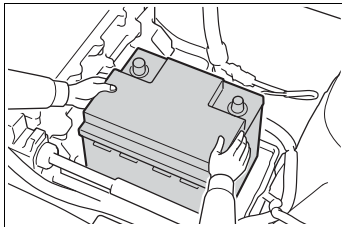

■ Alarm-operated door lock

In the following cases, depending on the situation, the door may automatically lock to prevent improper entry into the vehicle:

- When a person remaining in the vehicle unlocks the door and the alarm is activated.
- While the alarm is activated, a person remaining in the vehicle unlocks the door.
- When recharging or replacing the 12-volt battery.



NOTICE

■ To ensure the system operates correctly

Do not modify or remove the system. If modified or removed, the proper operation of the system cannot be guaranteed.

Electric Vehicle system**2****2-1. Electric vehicle system**

- Electric Vehicle system features 72
- Electric Vehicle system precautions..... 76
- Battery Electric Vehicle driving tips..... 81
- Driving range..... 83

2-2. Charging

- Charging equipment..... 85
- AC charging cable..... 87
- Locking and unlocking AC charging connector..... 93
- Power sources that can be used 96
- Charging methods..... 98
- Charging tips 100
- Things to know before charging 102
- How to use AC charging 105
- How to use DC charging 113
- Using the charging schedule function..... 118
- Using My Room Mode 129
- When charging cannot be carried out 133

Electric Vehicle system features

Battery electric vehicles are considerably different from conventional vehicles.

They use electricity charged in a traction battery, to drive the electric motor. Since battery electric vehicles are driven using electricity, they do not emit any emissions such as CO₂ (Carbon Dioxide) and NO_x (Nitrogen Oxides). Battery electric vehicles are environmentally friendly vehicles.

System components

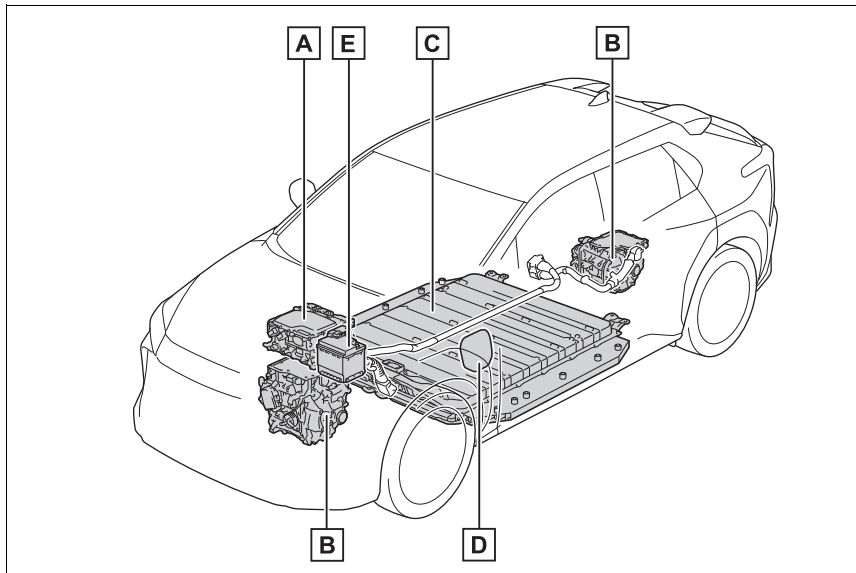

The illustration is an example for explanation and may differ from the actual item.

- A** ESU: Electricity Supply Unit (built in onboard traction battery charger/DC-DC converter)
- B** Electric motor (traction motor)/Inverter (front/rear^{*})
- C** Traction battery
Provides electricity to the electric motor.
- D** Charging port
- E** 12-volt battery

Provides electricity to various vehicle systems such as the SRS airbags, headlights, wipers, etc.

*: AWD models only

■ When braking (regenerative braking)

The electric motor (traction motor) charges the traction battery.

The driving range can be extended by actively using this regenerative braking to store electricity in the traction battery.

Charging

The battery electric vehicle is driven using electricity, which is received from an external power source and stored in the traction battery. Not only public charging stations, but also household outlets can be used for charging. Procedures are different from refueling a conventional vehicle. Therefore, make sure to read the following thoroughly.

- Charging equipment (→P.85)
- AC charging cable (→P.87)
- Power sources that can be used (→P.102)
- Things to know before charging (→P.102)
- How to charge your vehicle (→P.105, 113)
- When charging cannot be performed normally (→P.133)

■ Regenerative braking

In the following situations, kinetic energy is converted to electric energy and deceleration force can be obtained in conjunction with the recharging of the traction battery.

- The accelerator pedal is released while driving with the shift position in D.
- The brake pedal is depressed while driving with the shift position in D.

■ Charging the 12-volt battery

The 12-volt battery is charged from the traction battery when the EV system is operated or while the traction battery is being charged.

If the vehicle has not been used for a long time, the 12-volt battery may become low due to self-discharge. If this occurs, follow the correct procedures. (→P.541)

■ When not using the vehicle for an extended period of time

- When the vehicle will not be used for an extended period of time, charge the traction battery once a month.
This protects the traction battery from extreme voltage decline due to self discharging.
- When the vehicle will not be used for an extended period of time, the 12-volt battery will be charged from the traction battery to reduce the risk of the 12-volt battery discharged. In this case, the cooling fan may operate, however it is not a malfunction.
- To prevent the 12-volt battery from being discharged, do not leave the charging port lid open or the charging cable connected to the vehicle.

■ Charging the traction battery

Be sure to maintain the traction battery charge level suitable for your driving needs.

If the traction battery fully discharges, the vehicle cannot be driven at all. When the battery becomes low, charge it as soon as possible.

■ If the traction battery becomes low

- If the traction battery becomes low, the traction battery charge warning light comes on or flashes and a message will be displayed on the multi-information display. (→P.515)
- If the traction battery is completely discharged, the EV system cannot be started and driving will not be possible. When the traction battery becomes low, charge it as soon as possible.

■ Sounds and vibrations specific to an battery electric vehicle

Because there is no engine sound or vibration, it is easy to mistake the battery electric vehicle for being off when it is actually still running, as indicated by the "READY" indicator being illuminated. For safety, make sure to always shift the shift position to P and apply the parking brake when parked.

Before and after the EV system is started, the following sounds and vibrations may occur. However, these sounds and/or vibrations are not signs of malfunctions:

- The brake system operation sound may be heard from the front of the vehicle when the driver's door is opened.
- Motor sounds may be heard from the motor compartment or luggage compartment.
- Electrical relay sounds may be heard from the motor compartment when the EV system starts

or stops.

- Relay operating sounds such as a snap or soft clank will be emitted from the traction battery in the following situations:
 - When the EV system is started or stopped
 - When charging starts or completes
 - When the vehicle is driven the first time after the traction battery has been charged using DC charging
- Sounds may be heard due to regenerative braking when the brake pedal is depressed or as the accelerator pedal is released.
- Cooling fan operating sounds from the radiator.
- The operation sound of the air conditioning system (air conditioning compressor, blower motor).

■ Maintenance, repair, recycling, and disposal

Contact your Toyota dealer regarding maintenance, repair, recycling and disposal. Do not dispose of the vehicle yourself.

Acoustic Vehicle Alerting System

A sound which changes in accordance with the driving speed, will be played in order to warn people nearby of the vehicle's approach. This sound may be heard inside the vehicle. The sound will stop when the vehicle speed exceeds approximately 23 mph (37 km/h).

■ Acoustic Vehicle Alerting System

In the following cases, the Acoustic Vehicle Alerting System may be difficult for surrounding people to hear.

- In very noisy areas
- In the wind or the rain

Also, as the Acoustic Vehicle Alerting System is installed on the front of the vehicle, it may be more difficult to hear from the rear of the vehicle compared to the front.

Electric Vehicle system precautions

Be careful of the high voltage components (nominal voltage at 355.2 V), such as the traction battery, electricity supply unit, orange colored high voltage cables, and electric motor, as well as high temperature components such as the cooling radiator, which are provided on the battery electric vehicle. For the high voltage components, warning labels are provided on them. Read them when they need to be handled.

System components

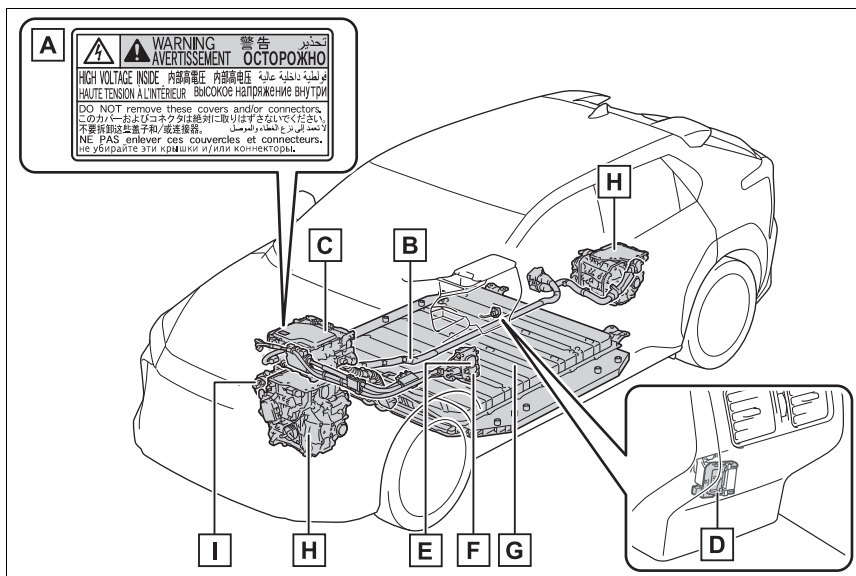

The illustration is an example for explanation and may differ from the actual item.

- A** Warning label
- B** High voltage cables (orange)
- C** ESU: Electricity Supply Unit (built in onboard traction battery charger/DC-DC converter)
- D** Service plug
- E** AC charging inlet

- F** DC charging inlet
- G** Traction battery
- H** Electric motor (traction motor)/Inverter (front/rear^{*})
- I** Air conditioning compressor

^{*}: AWD models only

■ Electromagnetic waves

- High-voltage parts and cables on the battery electric vehicles incorporate electro-magnetic shielding, and therefore emit approximately the same amount of electromagnetic waves as conventional gasoline-powered vehicles or home electronic appliances.
- Your vehicle may cause sound interference in some third party-produced radio parts.

■ Traction battery (Lithium-ion battery)

The traction battery has a limited service life.

The traction battery capacity (the ability to store energy) reduces with time and use in the same way as other rechargeable batteries. The extent at which capacity reduces changes drastically depending on the environment (outside temperature, etc.) and usage conditions, such as how the vehicle is driven and how the traction battery is charged.

This is a natural characteristic of lithium-ion batteries, and is not a malfunction. Also, even though the driving range decreases when the traction battery capacity reduces, vehicle performance does not significantly become worse. In order to reduce the possibility of the capacity reducing, follow the directions listed on P.103, "Capacity reduction of the traction battery".

■ Starting the EV system in an extremely cold environment

When the traction battery is extremely cold (below approximately -22°F [-30°C]) due to the temperature outside of the vehicle, it may not be possible to start the EV system. In this case, try to start the EV system again after the temperature of the traction battery increases due to the outside temperature increasing, etc.

WARNING

■ High-voltage precautions

The vehicle has high voltage DC and AC systems as well as a 12-volt system.

DC and AC high voltage systems are very dangerous and can cause severe burns and electric shock that may result in death or serious injury.

- Never touch, disassemble, remove, or replace the high voltage parts, cables (orange) or their connectors.
- The EV system will become hot after starting as the system uses high voltage. Be careful of both the high voltage and the high temperature, and always obey the warning labels attached to the vehicle.

⚠ WARNING

- Never try to open the service plug access hole located under the floor. The service plug is used only when the vehicle is being serviced and is subject to high voltage.

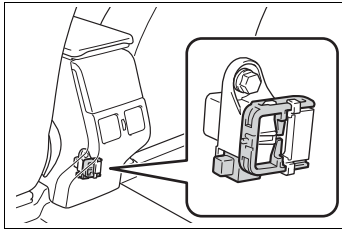

■ Road accident cautions

Observe the following precautions to reduce the risk of death or serious injury:

- Stop the vehicle in a safe place to prevent subsequent accidents. While depressing the brake pedal, apply the parking brake and shift the shift position to P to stop the EV system. Then, slowly release the brake pedal.
- Do not touch the high voltage parts, cables (orange) and connectors.
- If electric wires are exposed inside or outside your vehicle, an electric shock may occur. Never touch exposed electric wires.

- Do not touch the traction battery if liquid is leaking from or adhered to it. If electrolyte (Organic Carbonate-based electrolyte) from the traction battery comes into contact with the eyes or skin, it could cause blindness or skin wounds. In the unlikely event that it comes into contact with the eyes or skin, wash it off immediately with a large amount of water, and seek immediate medical attention.

- If electrolyte is leaking from the traction battery, do not approach the vehicle. Even in the unlikely event that the traction battery has been damaged, the internal construction of the battery will prevent a large amount of electrolyte from leaking out. However, if electrolyte leaks, vapors will be emitted. These vapors are an irritant to skin and eyes and could cause acute poisoning if inhaled.

- Do not bring burning or high-temperature items close to the electrolyte. The electrolyte may ignite and cause a fire.

- If a fire occurs in the battery electric vehicle, leave the vehicle as soon as possible. Never use a fire extinguisher that is not meant for electrical fires. Using even a small amount of water may be dangerous.

**WARNING**

- If your vehicle needs to be towed, be sure to transport the vehicle with the front wheels (2WD models) or four wheels (AWD models) raised. If the vehicle is towed with the wheels which are connected to the electric motor (traction motor) contacting the ground, electricity generated by the operation of the motor may cause a fire to occur depending on the nature of the damage or malfunction. (→P.507)

- Carefully inspect the ground under the vehicle. If leaked liquid (other than water from the air conditioning) is found on the ground, the traction battery may have been damaged. Leave the vehicle as soon as possible. In addition, contact your Toyota dealer with regard to the leakage found on the ground. Even in the event of a minor accident, the traction battery and surrounding parts may be damaged. In case of an accident, have the traction battery inspected at a Toyota dealer.

■ Traction battery

- Your vehicle contains a sealed lithium-ion battery.
- Never resell, hand over or modify the traction battery. To prevent accidents, traction batteries that have been removed from a disposed vehicle are collected through your Toyota dealer. Do not dispose of the battery yourself. Unless the battery is properly collected, the following may occur, resulting in death or serious injury:

- Do not illegally dispose of or dump the traction battery, and it is hazardous to the environment or someone may touch a high voltage part, resulting in an electric shock.
- The traction battery is intended to be used exclusively with your battery electric vehicle. If the traction battery is used outside of your vehicle or modified in any way, accidents such as electric shock, heat generation, smoke generation, an explosion and electrolyte leakage may occur. When reselling or handing over your vehicle, the possibility of an accident is extremely high because the person receiving the vehicle may not be aware of the dangers from these modifications.
- If your vehicle is disposed of without the traction battery having been removed, there is a danger of serious electric shock if high voltage parts, cables and their connectors are touched. In the event that your vehicle must be disposed of, the traction battery must be disposed of by your Toyota dealer or a qualified service shop. If the traction battery is not disposed of properly, it may cause electric shock that can result in death or serious injury.
- For information about traction battery collection locations, contact information, or the recycling process, contact your Toyota dealer.

WARNING

■ Caution while driving

- Pay special attention to the area around the vehicle. Because there is no engine noise, pedestrians, people riding bicycles or other people and vehicles in the area may not be aware of the vehicle starting off or approaching them, so take extra care while driving. Therefore, take extra care while driving even if the Acoustic Vehicle Alerting System is active.
- If the vehicle under floor area receives strong shock or impact while driving, stop the vehicle in a safe place and check around the bottom of the vehicle. If there is damage to the traction battery or liquid leakage, it may lead to a vehicle fire, etc. Do not touch the vehicle and immediately contact your Toyota dealer. Even if no damage can be seen under the floor, the traction battery may be damaged. If the vehicle received an impact under the floor, have the traction battery inspected at a Toyota dealer.

■ Modifications

Do not make modifications that lower the height of the vehicle. The traction battery in the under floor area may come into contact with the ground when the height of vehicle is lowered. If the traction battery is damaged, a vehicle fire may occur, possibly resulting in death or serious injury.

Emergency shut off system

When a certain level of impact is detected by the impact sensors, the emergency shut off system

turns off the EV system and blocks the high voltage current. If the emergency shut off system activates, your vehicle will not restart. To restart the EV system, contact your Toyota dealer.

Warning message

A message is automatically displayed when a malfunction occurs in the EV system or an improper operation is attempted.

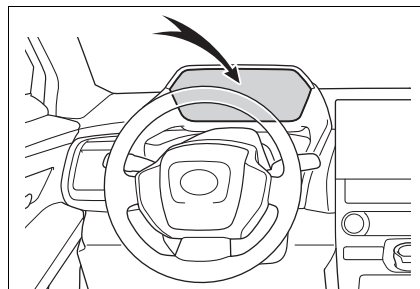

If a warning message is shown on the multi-information display, read the message and follow the instructions. (→P.140, 522)

■ If a warning light comes on, a warning message is displayed, or the 12-volt battery is disconnected

The EV system may not start.

In that case, try to start the system again. If the "READY" indicator does not come on, contact your Toyota dealer.

■ When the traction battery is completely discharged

When the EV system cannot be started due to the traction battery being completely discharged, restart the system after AC charging or DC charging. When charging, it is rec-

ommended to charge the traction battery until the traction battery charge warning light turns off in order to ensure sufficient driving distance.

Battery Electric Vehicle driving tips

Unlike the conventional vehicles, the electricity consumption efficiency of battery electric vehicles will decline if they continue driving on highways (or freeways) or at high average speeds, causing the possible driving distance to reduce. Therefore, if the remaining charge of the traction battery is low, avoid relying on the displayed possible driving distance too much as well as driving on highways (or freeways). Driving the vehicle at moderate speeds, the traction battery's electricity consumption can be controlled.

The following driving tips will contribute to reduction in the battery consumption and increase in the driving range.

Shift position operation

Shift the shift position to D when stopped at a traffic light, or driving in heavy traffic, etc. Shift the shift position to P when parking. When shifting the shift position to N while driving, there is no positive effect on electricity consumption. In the N, the traction

battery cannot be charged. Also, when using the air conditioning system, etc., the traction battery electricity is consumed. (→P.237)

Delays

Repeated acceleration and deceleration due to traffic congestion, long waits at traffic lights, and driving on steep inclines will lead to poor electricity consumption. In order to avoid those situations as much as possible, check traffic reports before leaving. If the vehicle is driven in traffic congestion, gently release the brake pedal to allow the vehicle to move forward slightly, avoid overuse of the accelerator pedal. Doing so can help minimize unnecessary electricity consumption.

When braking

Make sure to operate the brakes gently and a timely manner. A greater amount of electrical energy can be regenerated when slowing down.

Highway (or freeways) driving

Control and maintain the vehicle at a constant speed. Before stopping at a toll booth or similar, allow plenty of time to

release the accelerator and gently apply the brakes. A greater amount of electrical energy can be regenerated when slowing down.

Air conditioning

- Use the air conditioning only when necessary. Doing so can help reduce excessive electricity consumption.

In summer: When the ambient temperature is high, use the recirculated air mode. Doing so will help to reduce the burden on the air conditioning system and reduce electricity consumption as well.

In winter: Excessive or unnecessary heating should be avoided. Also, electricity consumption can be improved by avoiding overuse of the heater.

- When using the Remote Air Conditioning System (→P.409) while the AC charging cable is connected to the vehicle, electricity consumption immediately after starting off will be reduced because air conditioning is operated mainly using electricity from an external power source.

Checking tire inflation pressure

Make sure to check the tire inflation pressure frequently.

Improper tire inflation pressure can cause poor electricity consumption.

Also, as snow tires can cause large amounts of friction, their use on dry roads will lead to poor electricity consumption. Use tires that are appropriate for the season.

Luggage

Carrying heavy luggage will lead to poor electricity consumption. Avoid carrying unnecessary luggage.

Driving range

The driving range displayed on the multi-information display, etc., shows the reference distance that driving is possible, and the actual distance that can be driven may differ from that displayed.

Displayed value

A value for which a sufficient level of driving performance can be provided is estimated based on the remaining charge of the traction battery, the state of the traction battery, the outside temperature, etc., and is displayed on the multi-information display. (→P.152)

When the outside temperature is low, the traction battery output may be decreased, causing the possible driving distance to be shorter. However, this is not a malfunction. Charge the traction battery earlier than usual.

Tips for extending the driving range

Possible driving distance varies significantly depending on how the vehicle is driven, road conditions, the weather, the outside temperature, usage conditions of electrical components and the

number of occupants.

Possible driving distance could be extended if the followings are performed:

- Maintain a safe distance from the vehicle in front and avoid unnecessary acceleration and deceleration
- Accelerate and decelerate the vehicle as smoothly as possible
- Drive at moderate speeds as much as possible and maintain a constant speed
- Set the air conditioning system to a moderate temperature and avoid using the heating and cooling functions excessively.
- Use tires of the specified size and maintain the specified tire pressure
- Do not add unnecessary weight to the vehicle

Display when charging is completed

The followings indicate that charging has been carried out properly.

- The AC charging indicator turns off
- “Charging complete” is displayed on the multi-information display when a door is opened while the power

switch is off. (→P.101)

Regardless of the type of power source or whether the charging schedule function is used, charging is completed if the above can be confirmed.

Charging-related messages:
→P.140

Charging equipment

Charging equipment and names

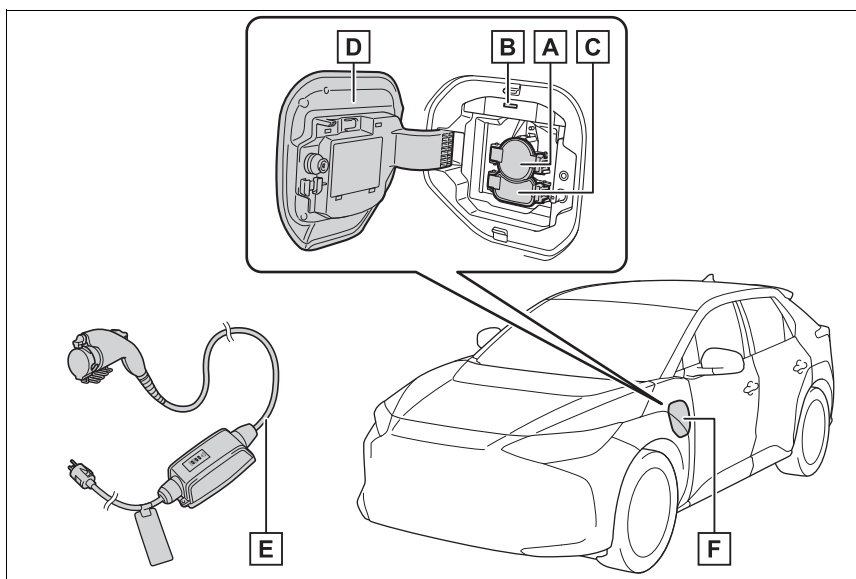

- A** AC charging inlet
- B** Charging indicator (→P.86) and Charging inlet light
- C** DC charging inlet
- D** Charging port lid (→P.85)
- E** AC charging cable (→P.87)
- F** Charging port

Opening/closing the charging port lid

by hand.

■ Open

Slightly open the charging port lid by pressing the rear edge of it (the position shown in the illustration)

Fully open the charging port lid

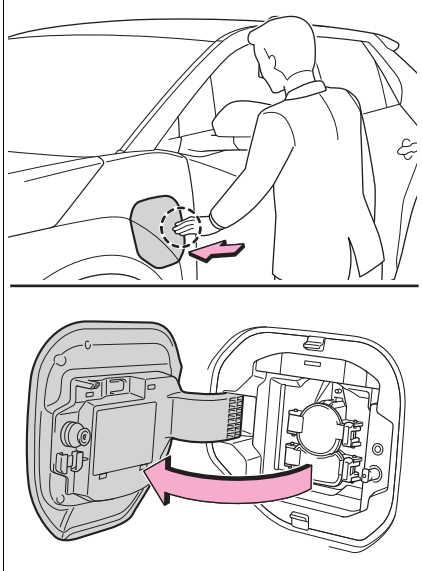

■ Close

Move the charging port lid to the slightly open position and then press the rear edge (the position shown in the illustration) to close it.

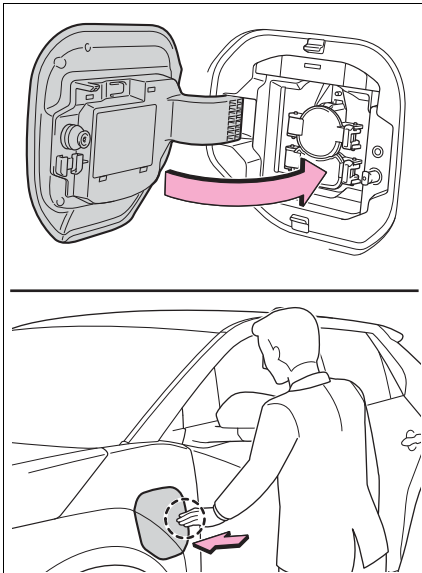

■ Lid lifter

- The charging lid is not closed if the lifter is pushing in before closing the charging lid. In that case, while unlocking the door, push again and release the lid lifter, and close the charging lid again.

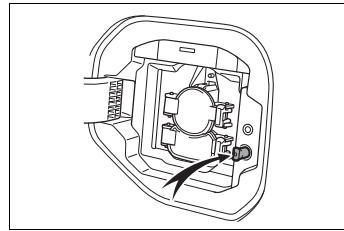

■ Charging port lid open/close detection switch

When the charging port lid is open, do not touch the charging port lid open/close detection switch (Position shown in the figure).

If you touch it by mistake, the vehicle may incorrectly display the opened/closed status of the charging port lid, or the charging connector may not be able to lock/unlock normally.

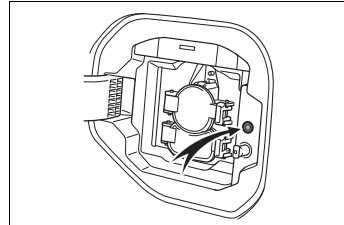

■ Charging indicator

The illumination/flashing pattern changes to inform the user of the charging status in the following ways.

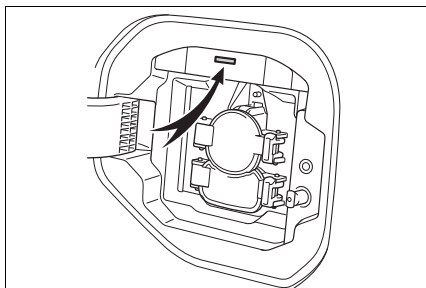

| Illumination/flash- ing pat- tern | Vehicle condition |
|---|---|
| Illumi- nated | <ul style="list-style-type: none"> • Charging is in progress^{*1} • Battery heater (→P.99) is operating |
| Flashes nor- mally ^{*2} | When charging sched- ule is registered (→P.118) and AC charging cable is con- nected to vehicle |
| Flashes rapidly ^{*2} | When charging cannot be carried out due to malfunction in a power source or the vehicle, etc. (→P.135) |

^{*1}: The indicator is dimmed when the charging is done

^{*2}: Flashes for a certain period of time, and then turns off.

AC charging cable

The function, correct operating procedure, etc., of the AC charging cable are explained.

WARNING

■ When using the AC charging cable and CCID (Charging Circuit Interrupting Device)

Observe the following precautions.

Failure to do so may cause an unexpected accident, resulting in death or serious injury.

- Do not attempt to disassemble or repair the AC charging cable, charging connector, plug or CCID (Charging Circuit Interrupting Device). If a problem arises with the AC charging cable or the CCID (Charging Circuit Interrupting Device), stop charging immediately and contact your Toyota dealer.
- Do not subject the AC charging cable, charging connector, plug or CCID (Charging Circuit Interrupting Device) to strong force or impact.
- Do not apply excessive force to the AC charging cable by forcefully folding, twisting, pulling or dragging the AC charging cable.
- Do not damage the AC charging cable with sharp objects.
- Do not fold the charging connector or plug or insert foreign objects into them.
- Do not put the charging connector and plug into water.

⚠ WARNING

- Do not bring the AC charging cable to a high-temperature item such as a heating device.
- Do not apply a load to the AC charging cable and plug-cord (such as wrapping the AC charging cable around the CCID (Charging Circuit Interrupting Device) and the charging connector).
- Do not use or leave the AC charging cable in situations where a load is applied to the outlet and the plug (such as when the CCID (Charging Circuit Interrupting Device) is hanging in the air without contacting the ground).

- After removing the charging connector, securely install the AC charging inlet cap.

- **When using the AC charging cable and related parts**

→P.105

- **Precautions for low temperatures**

In low temperatures, the AC charging cable and plug-cord may become hard. Therefore, make sure to not apply excessive force when they are hard. If excessive force is applied to the hardened AC charging cable and plug-cord, they may be damaged.

⚠ NOTICE

- **Precautions when handling AC charging cable**

Make sure to observe the following precautions. Failure to observe these precautions may result in damage to the AC charging cable and AC charging inlet.

- Insert the charging connector straight into the AC charging inlet.
- After inserting the charging connector, do not apply excessive force to or twist the connector. Also, do not lean on the connector or hang any objects from it.
- Do not step on or trip over the AC charging cable.
- Before removing the charging connector, make sure that it is unlocked. (→P.93)
- After removing the AC charging cable, promptly return it to its proper location.

The names of each part of the AC charging cable

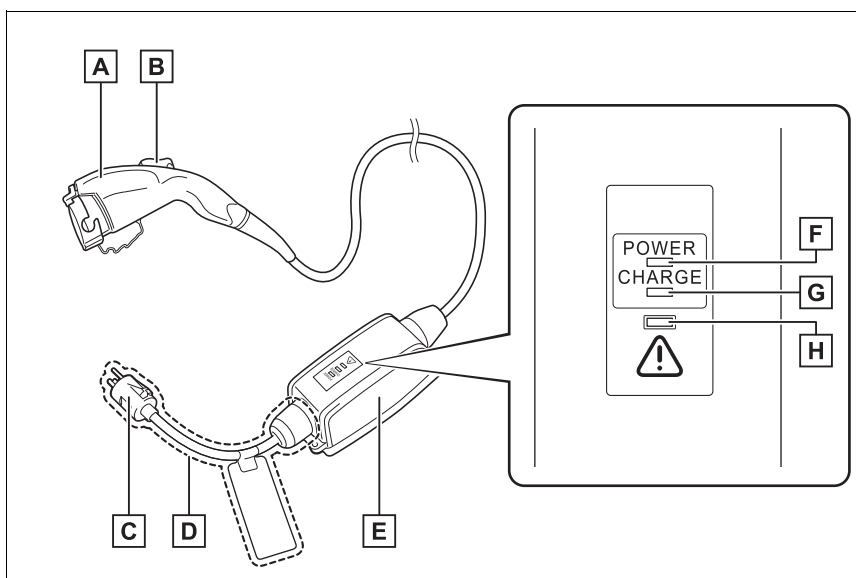

- A** Charging connector
- B** Latch release button
- C** Plug
- D** Plug-cord
- E** CCID (Charging Circuit Interrupting Device)
- F** Power indicator (→P.90)
- G** Charging indicator (CCID) (→P.90)
- H** Error warning indicator (→P.90)

Safety functions

The CCID (Charging Circuit Interrupting Device) has the following safety features.

■ Electrical leakage detection function

If an electrical leakage is detected during charging, the

power source will be automatically interrupted, thus preventing fires or electrical shocks caused by electrical leakage.

If the power source is interrupted, the error warning indicator flashes.

If the power source is interrupted:
→P.90

■ Automatic check function

This is an automatic system check that is run before charging begins to check for problems in the operation of the electrical leakage detection function.

If a malfunction is found in the electrical leakage detection function as a result of the check, the error warning indicator flashes to inform the user. (→P.90)

■ Temperature detection function

A temperature detection function is equipped to the plug. While charging, if heat is generated due to looseness on the outlet side etc., this function suppresses heat by controlling the charging current.

■ Conditions for supplying current to the vehicle

The CCID (Charging Circuit Interrupting Device) is designed to prevent electrical current from being supplied to the charging connector when it is not connected to the vehicle, even if the

■ When a malfunction occurs during charging

The indicators on the CCID (Charging Circuit Interrupting Device) use a combination of different statuses (not illuminated, illuminated or flashing) to inform the user of internal malfunctions.

When the error warning indicator is illuminated or flashing, temporarily remove the plug from the outlet and then reconnect it to check if the error indicator turns off.

If the error warning indicator turns off, charging is now possible.

plug is inserted into the outlet.

CCID (Charging Circuit Interrupting Device) indicators

■ Indicator operation

3 indicators are used to indicate the following conditions.

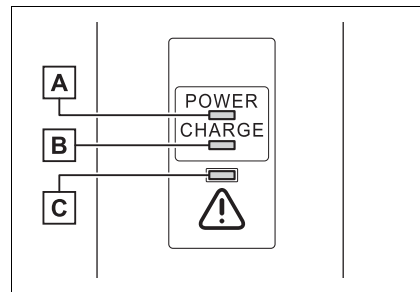

A Power indicator

Illuminates when electricity is flowing to the CCID (Charging Circuit Interrupting Device).

B Charging indicator

Illuminates when charging is in progress.

C Error warning indicator

Flashes when there is an electrical leakage or when a malfunction occurs in the CCID (Charging Circuit Interrupting Device).

If it does not turn off, perform the correction procedure in the following chart.

| Status | Power indicator | Error warning indicator | Details/Correction procedure |
|--|-----------------|--------------------------------|---|
| Charging system error | Not illuminated | Not illuminated or illuminated | An electrical leakage is detected and charging is canceled, or there is a malfunction in the AC charging cable. → Consult your Toyota dealer |
| | Illuminated | Flashes | |
| Plug temperature detection malfunction | Flashes | Flashes | There is a malfunction in the plug temperature detection part. → Consult your Toyota dealer |
| Plug temperature increase detection | Flashes | Not illuminated | An increase in the temperature of the plug is detected due to an improper connection between the outlet and plug. → Check that the plug is securely connected to the outlet |
| AC charging cable life span notice | Illuminated | Flashes | The number of charges using the AC charging cable is nearing the end of its usable life span. → Consult your Toyota dealer |
| AC charging cable life span | Illuminated | Illuminated | The number of charges using the AC charging cable has exceeded its usable number of charges. → Consult your Toyota dealer |

Inspecting the AC charging cable

For safety, inspect the AC charging cable on a routine basis.

WARNING

■ Routine inspection

Check the following points regularly.

Failure to do so may cause an unexpected accident, resulting in death or serious injury.

- The AC charging cable, plug, charging connector, CCID (Charging Circuit Interrupting Device), etc., have not been damaged
- The outlet has not been damaged.
- The plug can be securely inserted into the outlet.
- The plug does not get extremely hot during use
- The tip of the plug has not been deformed.
- The plug is not dirtied by dust, etc.

Remove the plug from the outlet before inspecting it. If any abnormalities are found in the AC charging cable as a result of the inspection, immediately stop use and consult your Toyota dealer.

■ Maintaining the AC charging cable

When the AC charging cable is dirty, first remove the dirt with a hard, wringed cloth, and then wipe the cable with a dry cloth.

However, never wash it with water. If the AC charging cable is washed with water, fire or electric shock may occur during charging, possibly resulting in death or serious injury.

■ When not using the AC charging cable for a long time

Remove the plug from the outlet. Dust could accumulate on the plug or in the outlet, possibly causing overheating which could lead to a fire.

Also, keep the cable in a place free from moisture.

Locking and unlocking AC charging connector

The AC charging connector will be locked when it is connected to the AC charging inlet, preventing the AC charging cable from being disconnected while charging.

Locking and unlocking the AC charging connector

■ Locking the charging connector

The AC charging connector will be automatically locked when inserting it into the AC charging inlet.

(The setting can be changed:→P.93)

■ Unlocking the charging connector

The AC charging connector will be unlocked when the doors are unlocked using the smart key system or wireless remote control.

The AC charging connector locks when connected and unlocks when the door is unlocked, so locking/unlocking the AC charging connector does not necessarily correspond to locking/unlocking the door.

If the door is unlocked and the AC charging connector is locked, you can unlock it by doing the following:

- When using the smart key system, lock the door once and then unlock it again. (→P.167)
- When using the wireless remote control, press the unlock button to unlock the door. (→P.167)





■ Changing the AC charging connector lock settings

The method for locking and unlocking the AC charging connector can be changed on the multi-information display or multimedia.

The charging connector lock settings cannot be changed when the AC charging cable is connected to the vehicle.

The settings cannot be changed when the power switch is in ACC.

● Multi-information display operation

- 1 Press  or  of the meter control switches to select .
- 2 Press  or  of the meter control switches to select "Vehicle Settings", and then press and hold OK.

- 3 Press \wedge or \vee of the meter control switches to select “Charging Settings”, and then press OK .

The “Charging Settings” screen will be displayed.

- 4 Press \wedge or \vee of the meter control switches to select “Connector Lock”, and then press OK .

The “Connector Lock” screen will be displayed.

● Multimedia operation

- 1 Select  on the main menu.
- 2 Select “Vehicle customize”.
- 3 Select “Charging”.
- 4 Select “Connector lock”.

AC charging connector locking/unlocking settings can be changed as follows.

| Setting | Operation description |
|----------------------------------|--|
| “Auto Lock” (Default setting) | The AC charging connector is automatically locked when the AC charging connector is connected. |
| “Auto Lock & Unlock” | The AC charging connector is automatically locked when the AC charging connector is connected and automatically unlocked when charging is completed.*1, 2, 3 |
| “OFF” | Not using the AC charging connector locking system |

*1: The AC charging connector will be unlocked if power supply is interrupted due to a power outage, etc., after the AC charging connector is automatically locked.

*2: The AC charging connector can be unlocked by similar operations to that of “Auto Lock” (Default setting).

*3: When the stop time of the charging schedule “Start-Stop” setting is reached, the AC charging connector is unlocked even if it is not fully charged.

■ **AC charging connector lock function**

If the AC charging connector is locked/unlocked repeatedly, it may not work temporarily due to protect the system by AC charging system. In this case, wait for a while before connecting the AC charging connector to AC charging inlet again.

The AC charging connector lock function does not guarantee that theft of the AC charging cable will be prevented, and is not necessarily effective for all mischiefs.

■ **Security function for unlocking**

If the AC charging connector is not removed within approximately 30 seconds after the vehicle is unlocked, the security function automatically locks the connector again.

■ **When the AC charging connector cannot be inserted into the AC charging inlet**

If the connector lock pin is extended, the connector lock is operating.

Unlock the doors using the smart key system or wireless remote control and unlock the AC charging connector lock and check that the connector lock pin is not extended.

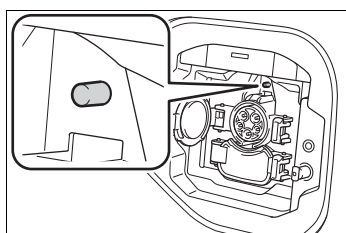

■ **If the AC charging connector cannot be unlocked**

The AC charging connector can be unlocked by operating the emergency release wire.

- 1 Open the hood. (→P.462)
 - 2 Pull the emergency release wire.
- The AC charging connector is

unlocked and can be removed.

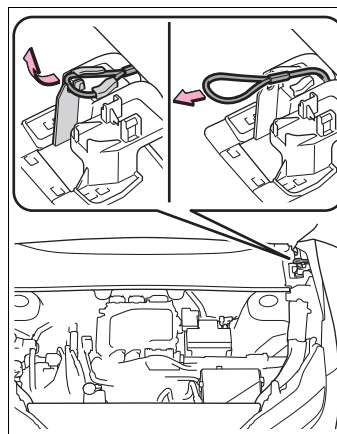

- 3 After unlocking the AC charging connector, fix the handle of the emergency release wire to the attachment.

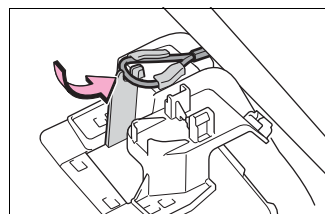

This method is a temporary correction procedure for emergency use only. If the problem persists, have the vehicle inspected by your Toyota dealer immediately.

Do not operate the emergency release wire when the charging connector can be unlocked in the normal procedure.

⚠ WARNING**■ When connecting the AC charging connector to the AC charging inlet**

- Do not insert hand into the connector lock portion. A hand may be caught in the connector lock pin, resulting in an injury.

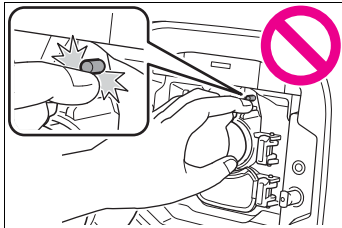
**⚠ NOTICE****■ When locking the AC charging connector**

Observe the following precautions. Failure to do so may cause a malfunction in the charging connector locking system.

- Check that the AC charging connector is compatible with this vehicle.
A charging connector of the different type or a charging connector with damaged or deformed insertion part may not be locked.
- Do not apply excessive force to the AC charging connector when the AC charging connector is locked.
When removing the AC charging connector, make sure to unlock the AC charging connector.

Power sources that can be used

An external power source that fulfills the following criteria is necessary for charging this vehicle. Confirm this before charging.

⚠ WARNING**■ Warnings for electrical faults**

Make sure to observe the precautions in this Owner's Manual when charging the vehicle.

Failure to use a power source that fulfills the requirements, or failure to observe regulations while charging could lead to an accident, possibly resulting in death or serious injury.

Power sources

- Connect to an AC 120 V outlet (NEMA 5-15R) with a Ground-Fault Circuit-Interrupter (GFCI) and a circuit breaker. Use of a 15A individual circuit is strongly recommended to ensure AC charging cable will operate properly.
- When charging outdoors, make sure to connect to a weatherproof outlet that is certified for outdoor use. Checking Ground-Fault Circuit-Interrupter (GFCI) operation before its use is recommended.

Outlets that can be connected

NEMA 5-15R outlet

The illustration is an example shown for demonstration purposes, and may differ from the actual configuration.

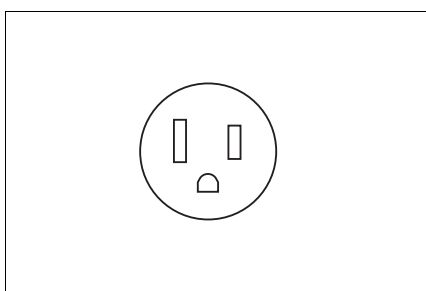

The charging environment

For safe charging, the following charging equipment and settings are recommended.

● Weatherproof outlet

When charging outdoors, connect the plug to a weatherproof outlet, and ensure that the plug remains waterproof while the plug is connected.

● Dedicated circuit

- To reduce the risk of fire, connect only to an at least 15A branch circuit with an over-current protection in accordance with the National Electric Code, ANSI/NFPA 70.
- To reduce the risk of electric shock when working with the plug, connect to a outlet with a Ground-Fault Circuit-Interrupter (GFCI) or that has an Earth Leakage Circuit Breaker installed.

⚠ WARNING

Power sources precautions

Observe the following precautions.

If you do not follow them, fire, electrical shock or damage may occur, possibly resulting in death or serious injury.

- Connect to an AC 120 V outlet (NEMA 5-15R) with a Ground-Fault Circuit-Interrupter (GFCI) and supplied by a circuit breaker per your local code. Use of a 15A individual circuit is strongly recommended.
- Do not connect the AC charging cable to a multi-outlet adaptor, multi-plugs, or conversion plug.

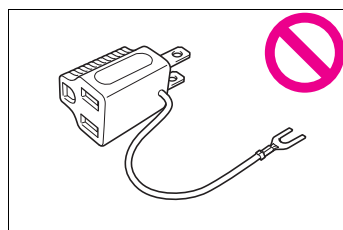

- Connecting the AC charging cable to an extension cord is strictly prohibited. The extension cord may overheat and does not contain a Ground-Fault Circuit-Interrupter (GFCI). The leakage detection function of the CCID (Charging Circuit Interrupting Device) (→P.90) may not operate correctly.

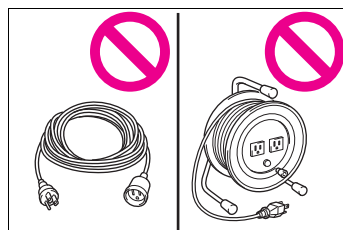

⚠ WARNING

- Do not connect to a power strip.

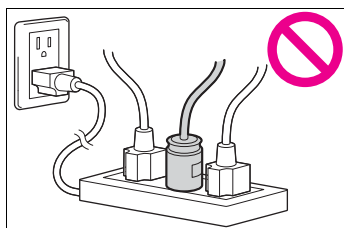

- Use of a block heater for charging is prohibited.
- Make sure to connect the charging connector and AC charging inlet directly. Do not connect a converting adaptor or extension cord between the charging connector and AC charging inlet.

Charging methods

The following methods can be used to charge the traction battery.

Types of charging methods

■ AC charging (→P.105)

This is a charging method used when charging from an AC outlet with the AC charging cable or charging that uses AC charger.

By setting charging schedule, it is also possible to charge at the desired date and time. (→P.118)

■ DC charging (→P.113)

This is a charging method that uses a DC charger that complies with SAE J 1772. The traction battery can be charged in a shorter time than AC charging.

SAE is an abbreviation for an industrial standard issued by the Society of Automotive Engineers.

Charging-linked functions

This vehicle is equipped with several functions that are linked with charging.

■ My Room Mode (→P.129)

When the charging cable is connected to the vehicle, electrical components such as the air conditioning system and audio sys-

tem can be used by the power supply from an external power source*.

*: Depending on the situation, electricity of the traction battery may be consumed.

■ Traction battery heater

When the outside temperature is low and the charging cable is connected to the vehicle, this function automatically warms the traction battery until it reaches or exceeds a certain temperature.

- The operation of this function is stopped automatically when the charging cable is disconnected or if the charging cable is left connected to the vehicle for approximately 3 days.
- When the charging schedule is used (→P.118), this function will operate according to the schedule settings.

■ Traction battery warming control

This control operates after the charging cable remains connected to the vehicle for approximately 3 days and the traction battery heater automatically stops. It automatically insulates the traction battery in extremely low temperatures.

- This control stops 31 days after the charging cable is connected, even if it is still connected to the vehicle.

- When this control operates, charging schedule settings are ignored and charging starts immediately.

■ Traction battery cooler

When the traction battery is hot and the AC charging cable is connected to the vehicle, this function cools the traction battery to protect it.

The function may operate when continuously driving at high speeds such as driving on highways or freeways, or during DC charging.

■ Using My Room Mode during DC charging

→P.130

■ Traction battery heater

- Traction battery heater may operate when charging is not being performed.
- When Traction battery heater is operating, the charging indicator will illuminate.
- When Traction battery heater is operating during charging, the charging may take longer than normal.
- The remaining charge of the traction battery declines when the traction battery heater operates, it might be necessary to recharge the traction battery again in order to supplement the remaining charge.

■ Traction battery cooler

- For AC charging: Traction battery cooler settings can be changed on the multi-information display. (→P.100)
- The AC charging indicator will illu-

minate when the traction battery cooler is on standby or operating.

- When the charge level of the traction battery is low, the traction battery cooler may not operate, even if the temperature of the traction battery is high.
- When the following conditions are met while the traction battery cooler is operating, the cooling operation will stop.
 - The hood is opened
 - The power switch is turned to ACC or ON.
 - The shift position is changed to any position other than P
 - The Remote Air Conditioning System is operated (→P.409)
 - The remaining charge of the traction battery drops below a certain amount
- The traction battery cooler operates using power supplied by the traction battery and an external power source.
- While the traction battery cooler is operating, the charge of the traction battery will increase and decrease within a certain range, and will not increase as during AC charging.
- When the traction battery cooler operates, charger will recognize it as the battery being charged. If this function operates while a charger which charges a charging fee is connected to the vehicle, AC charging fees will apply.

■ Changing of the traction battery cooler setting

Setting can be changed  on the multi-information display.

Use the meter control switches (→P.156) and select “Vehicle Settings”, “Charging Settings”, “Battery Cooler”, and change the setting.

When selecting to off, the traction battery output may be restricted depending on the driving situation.

Charging tips

This section explains methods for using the charging function for this vehicle and checking information related to charging.

Systematically charging

To enable the use of battery electric vehicle, we recommend systematically charging the vehicle.

■ Before leaving home

In order to use the battery electric vehicle, charge the traction battery at home before leaving.

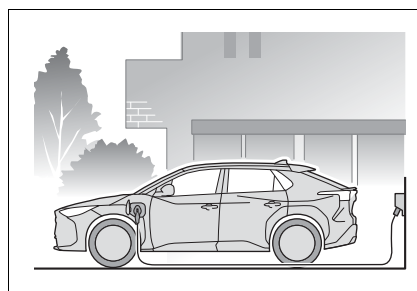

■ On the way to the destination or at the destination

When the remaining charge of the traction battery gets low, recharge the battery at the nearest charging station.

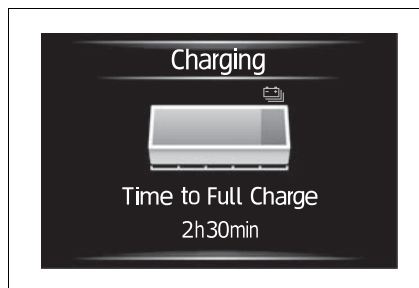
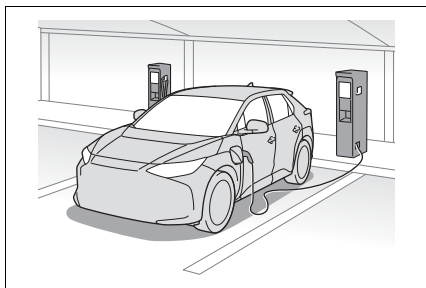

Checking information related to charging

Information related to charging is displayed and can be checked on the multi-information display.

■ While charging

When any door is opened during charging with the power switch off, the current charging condition and approximate time remaining until charging is complete are displayed for a certain period of time.

The actual charging time may differ depending on conditions such as the remaining capacity of the traction battery, outside temperature, and specifications of the AC/DC charger.

The time until charging completed may not be displayed if the charging current to the traction battery becomes smaller and the charging time becomes longer.

■ After charging is complete

When any door is opened with the power switch off after charging is complete, a message detailing the results of the charging is displayed for a while.

Also, a message is displayed if an operation that stops charging is performed or a situation where charging cannot be performed occurs.

When a message is displayed, follow the instructions displayed on the screen. (→P.140)

Things to know before charging

Make sure to read the following precautions before charging the traction battery.

■ Safety functions

- The EV system will not start while the charging cable is attached to the vehicle, even if the power switch is operated.
- If the charging cable is connected while the “READY” indicator is illuminated, the EV system will stop automatically and driving will not be possible.

⚠ WARNING

■ Caution when charging

People with implantable cardiac pacemakers or cardiac resynchronization therapy-pacemakers should not carry out the charging procedure. Ask someone else to do it.

- Do not approach the charger and charging cable while charging.
Charging procedure may affect the operation of such devices.
- Do not remain in the vehicle during charging.
Charging procedure may affect the operation of such devices.
- Do not enter the vehicle even to take something out of the luggage compartment.
Charging procedure may affect the operation of such devices.

■ When the charging cable is connected to the vehicle

Do not change the shift position from P.

In the unlikely event that the charging cable has been damaged, the shift position may change from P to another position and the vehicle could move, possibly leading to an accident.

■ Charging precautions

This vehicle has been designed to allow charging from an external power source using an AC charging cable for exclusive use with standard household AC outlets.

However, the vehicle differs greatly from standard household electrical goods in the following ways, and incorrect usage could cause fire or electric shock, possibly leading to death or serious injury.

- When 240V charging, a large amount of current will flow for a long time.
- Charging can be conducted outdoors.

⚠ NOTICE

■ Charging precautions

To charge properly, follow the procedure after reading the explanation below. Charging is intended to be carried out by licensed drivers only who properly understand the charging procedure.

- Do not allow people who is not used to charging, such as children, to perform charging without supervision.
Also, keep the AC charging cable out of reach of infants.

**NOTICE**

- When charging with a charger, follow the procedures for using each charger.

Confirm the following before charging

Before charging, always check the following items.

- The parking brake is applied. (→P.243)
- The power switch is turned to OFF. (→P.231)
- Lights such as the headlights, emergency flashers and interior lights, etc. are turned off.

If these light switches are turned on, then these features will consume electricity, and charging time will increase.

Inspecting the AC charging cable

Before charging, make sure that each part of the AC charging cable is in good condition. (→P.92)

■ During charging

- The charging starting time may differ depending on the state of the vehicle, but this does not indicate a malfunction.
- During charging, sounds may be heard from near the traction battery in accordance with the operation of the air conditioning system or "Battery Cooler" (→P.99).
- During and after charging, the

motor compartment and its surrounding area in which the onboard traction battery charger is installed may get warm.

- The surface of the CCID (Charging Circuit Interrupting Device) may become hot, but this does not indicate a malfunction.
- Depending on radio wave conditions, interference may be heard on the radio.

■ When charging using a public charging facility

- When charging using a public charging facility, check the setting of the charging schedule function.
- When the charging schedule is registered, temporarily turn off the function or turn "Charge Now" on. (→P.119)
- When the charging schedule is set to on, charging will not start even if the AC charging cable is connected. Also, charging fee may occur due to connection of the AC charging cable.

■ Capacity reduction of the traction battery

The capacity of the traction battery will decline gradually when the traction battery is in use. The rate at which it declines will differ in accordance with environmental conditions and the way in which the vehicle is used. Observing the following can help suppress the decline in the traction battery capacity.

- Avoid parking the vehicle in high temperature areas, under direct sunlight when the traction battery is fully charged.
- Avoid accelerating and decelerating frequently and suddenly.
- Avoid frequent driving at high speed.
- Use the charging schedule function as much as possible in order to fully charge the traction battery before starting off. (→P.118)

- Avoid frequent DC charging

Also, if the capacity of the traction battery capacity reduces, the distance that can be driven decreases. However, vehicle performance does not significantly become worse.

- **When the remaining charge of the traction battery is low after charging**

In the following situations, the remaining charge of the traction battery after charging completes may be less than normal in order to protect the traction battery (the driving range after the battery is fully charged may be shorter).*

- Charging is performed when the outside temperature is low or high
- Charging is performed immediately after high-load driving or in extreme heat

In any other situation, if the remaining charge of the traction battery is significantly lower than normal after charging completes, have the vehicle inspected by your Toyota dealer.

*: When this occurs, even if the remaining charge display of the traction battery shows that it is fully charged, the remaining charge rapidly decreases faster than normal.

- **When the charging amount sent to the traction battery decreases**

When the amount of power supplied by the charger is low or operation of the battery heater, etc., reduces the charging power sent to the traction battery, the charging amount sent to the traction battery may decrease.

- **Certification**

This device complies with Part 15 of the FCC Rules. Operation is subject to the following two conditions:
(1) this device may not cause harm-

ful interference, and (2) this device must accept any interference received, including interference that may cause undesired operation.

- **Charging time may increase**

In the following situations, charging time may become longer than normal:

- In very hot or very cold temperatures.
- When the traction battery becomes hot, such as immediately after high-load driving.
- The vehicle is consuming a lot of electricity, for example, when the headlights are on, etc.
- When using "My Room Mode". (→P.129)
- There is a power outage during charging.
- There is an interruption in the electrical supply.
- There is a drop in the voltage of external power source.
- The charge in the 12-volt battery is low, for example due to the vehicle being left unused for a long period of time.
- When the upper limit of charging current is changed in the charging current setting of the vehicle (→P.108)
- When the battery heater operates. (→P.99)
- When the "Battery Cooler" is operated before charging. (→P.99)
- When the plug generates heat due to a loose outlet connection, etc.
- When adjusting the power supply with the charger.
- When frequently and repeatedly using DC charging.
- When selecting "DC charging power" setting other than "MAX".
- When the temperature of charging-related parts is high.

■ Charging electricity

This vehicle can be charged up to approximately 7 kW.

However, depending on the used charger or AC charging cable, charging electricity may be limited.

How to use AC charging

This section explains the procedure for charging the traction battery with an AC charging cable.

When using an AC charger, make sure to check the operation instructions of the AC charger.

When the charging schedule is registered, make sure “Charge Now” is turned on before charging. (→P.124, 128)

**NOTICE****■ When using the AC charging cable and related parts**

To prevent damage to the AC charging cable and related parts, observe the following precautions.

- When interrupting or canceling charging, remove the charging connector before removing the plug.
- When removing the AC charging cable, check that the charging connector is unlocked.
- Do not forcefully pull the charging connector cap and AC charging inlet cap.
- Do not apply a vibration to the charging connector while charging. Charging may be stopped.
- Do not insert anything but the charging connector into the AC charging inlet.

 NOTICE

- When inserting the plug into or removing the plug from the outlet, make sure to hold the body of the plug.
- Do not damage the AC charging inlet cap with a sharp object.
- Do not forcefully pull the AC charging cable that is caught or entangled. If the cable is entangled, disentangle it before using.

■ AC charging inlet

Do not disassemble, repair or modify the AC charging inlet. When the AC charging inlet needs to be repaired, consult your Toyota dealer.

plug, use a string, etc., to hang the CCID (Charging Circuit Interrupting Device) on a hook or equivalent.

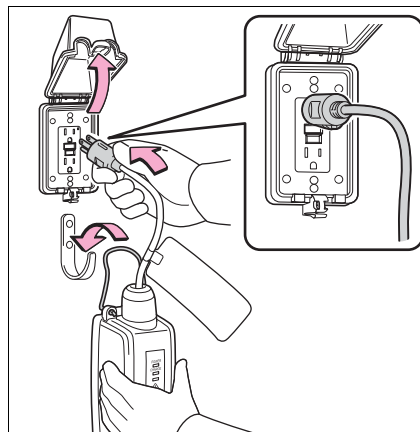

- 3 Open the charging port lid. (→P.85)

Charging precautions

→P.102

When charging

- 1 Prepare the AC charging cable. (→P.87)
- 2 Insert the plug of the AC charging cable into the outlet of the external power source.

Make sure to hold the body of the plug and insert it firmly into the outlet.

If there is a switch that can switch the power supply to the outlet, turn it on.

Check that the power indicator on the CCID (Charging Circuit Interrupting Device) is illuminated.

(If it is not illuminated, refer to P.133)

In order to reduce the load on the outlet and plug, when inserting the

The charging inlet light **A** will illuminate.

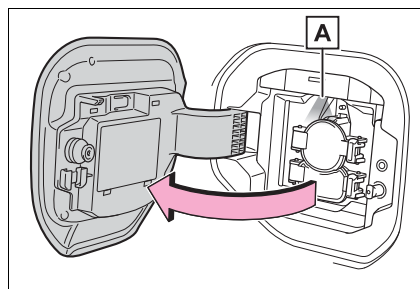

- 4 Open the AC charging inlet cap.

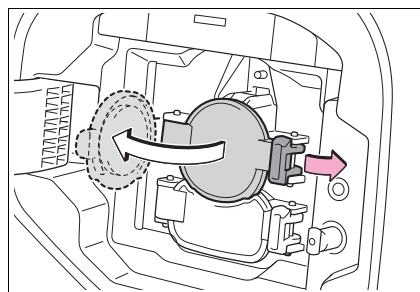

- Remove the charging connector cap and secure it to the cable.

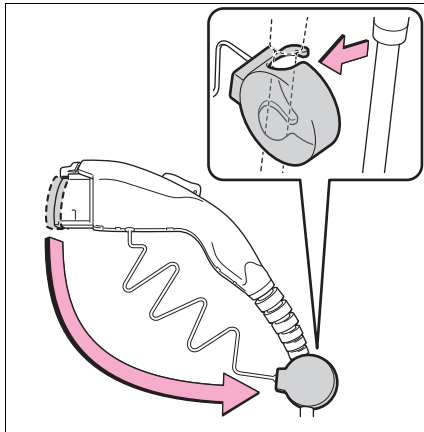

- Insert the charging connector into the AC charging inlet.

Align the guide position on the bottom of the charging connector, and push the charging connector straight into the AC charging inlet as far as possible. Once a click sound is heard, check that the charging connector is securely locked.

When the charging connector is inserted straight as far as possible, it will automatically lock. (→P.93)

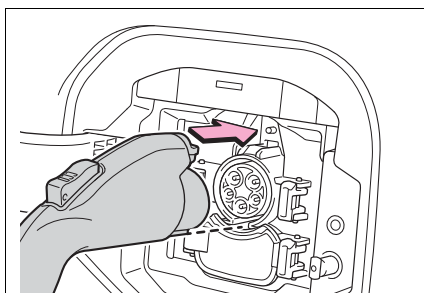

- Confirm that the charging indicator of the charging port is illuminated.

Charging will not start if the charging indicator does not illumi-

nate when the charging connector is inserted. (→P.133)

If the charging indicator is flashing, the charging schedule is registered. (→P.107)

If the error warning indicator on the CCID (Charging Circuit Interrupting Device) flashes during charging, check P.90 and follow the correction procedure.

The charging indicator will turn off when charging is completed.

The charging indicator will also turn off when charging is interrupted. In this case, refer to P.133

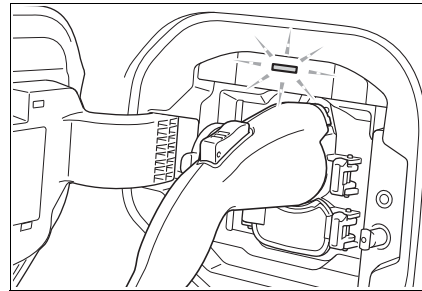

■ **When connecting the AC charging connector**

If the door is opened or the power switch is turned to ON with the AC charging connector connected, the charging cable indicator turns on to notify that the AC charging connector is connected.

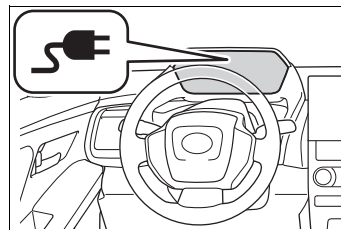

■ **If the charging indicator of the charging port flashes after connecting the AC charging cable**

The charging schedule (→P.118) is registered and charging cannot be performed. To cancel charging using

the charging schedule and start charging, perform any of the following procedures.

- Turn “Charge Now” on (→P.124, 128)
- While the charging indicator is flashing, remove and reconnect the charging connector immediately

■ **When the charging connector cannot be inserted into the AC charging inlet**

→P.93

■ **Safety function**

If the latch release button is pressed, charging will not begin even if the AC charging cable is connected.

Also, charging will be stopped if the latch release button is pressed and held for several seconds during charging. When restarting charging, reinsert the charging connector after pulling it out, and check that the charging indicator of the charging port illuminates.

■ **Charging time may increase**

→P.104

■ **When your circuit breaker trips during charging**

The upper limit of the charging current can be changed on the multi-information display or multimedia.

- Setting operations on multi-information display

- 1 Press or of the meter control switches to select .
- 2 Press or of the meter control switches to select “Vehicle Settings”, and then press and hold OK.
- 3 Press or of the meter control switches to select

“Charging Settings”, and then press OK.

The “Charging Settings” screen will be displayed.

- 4 Press or of the meter control switches to select “Charging Current”, and then press OK.

The “Charging Current” screen will be displayed.

- 5 Press or of the meter control switches to select “16A” or “8A” and then press OK.

- Setting operations on multimedia

- 1 Select .
- 2 Select “Vehicle customize”.
- 3 Select “Charging”.
- 4 Select “Charging current”.
- 5 Select “16A” or “8A”.

The maximum charging current is limited to less than or equal to the selected current.*

If the breaker still trips while charging, even after changing the upper limit of the charging current, check if the connected power source meets the specified charging conditions. (→P.96)

*: Restricting the charging current will lengthen the charging time.

■ **Changing the “Charging Limit” settings**

The upper limit of the charge capacity can be changed on the multi-information display or multimedia.

The selected upper limit value is common to AC charging and DC charging.

- Setting operations on multi-information display

- 1 Press \wedge or \vee of the meter control switches to select .
- 2 Press \leftarrow or \rightarrow of the meter control switches to select "Vehicle Settings", and then press and hold OK.

- 3 Press \wedge or \vee of the meter control switches to select "Charging Settings", and then press OK.

The "Charging Settings" screen will be displayed.

- 4 Press \wedge or \vee of the meter control switches to select "Charging Limit", and then press OK.

The "Charging Limit" screen will be displayed.

- 5 Select "Full", "90%", "80%", "70%", "60%" or "50%" and then press OK.

● Setting operations on multimedia

- 1 Select .
- 2 Select "Vehicle customize".
- 3 Select "Charging".
- 4 Select "Charging limit".
- 5 Select "Full", "90%", "80%", "70%", "60%" or "50%".

If the setting is changed during DC charging, charging may stop due to the operation of the DC charger timer and the traction battery cannot be fully charged.

■ Protection function of AC charging inlet overheating

By installing a temperature sensor to the AC charging inlet, prevents parts from melting when the temperature rises due to foreign matter entering the charging connector.

When a certain temperature increase is detected, charging is stopped immediately.

After this, when the power switch is off, a message will be displayed on the multi-information display (→P.140)

WARNING

■ When charging

Observe the following precautions.

Failure to do so may cause an unexpected accident, resulting in death or serious injury.

- Connect to a power source suitable for charging. (→P.96)
- Check that the AC charging cable, plug and outlet are free of foreign matter.
- Before charging, check that the AC charging inlet is not deformed, damaged or corroded, and check that the inlet is free of foreign matter such as dirt, snow and ice. If there is dirt or dust in these areas, remove completely before inserting the charging connector.
- Do not get the terminals of the AC charging inlet wet.
- Only use outlets where the plug can be securely inserted.
- Do not bundle or wind the AC charging cable while charging, as doing so may result in overheating.
- Do not touch the terminals of the charging connector and AC charging inlet with a sharp metal objects (needles, etc.) or hands, or short them with foreign objects.



WARNING

- When charging outdoors, make sure to connect to a weatherproof outlet for outdoor use. Ensure the weatherproof outlet cover closes completely. If the weatherproof outlet cover cannot be closed, install a weatherproof outlet cover that will close.
- In order to stop charging at the charging station, follow the instructions of the charger.
- If any heat, smoke, odors, noise or other abnormalities are noticed during charging, stop charging immediately.
- Do not insert the plug if the outlet is submerged in water or snow.
- When charging while it is raining or snowing, do not connect or disconnect the plug if your hands are wet. Also, do not get the plug or outlet wet.
- Do not charge the vehicle during a lightning storm.
- Prevent the AC charging cable from being caught in the door or back door.
- Do not let the wheels on the AC charging cable, plug, charging connector and CCID (Charging Circuit Interrupting Device).
- Firmly insert the plug into the outlet.
- Do not use an extension cord and converting adaptor.

- Close the hood before using the charging system.
The cooling fan may start operating suddenly. Touching or getting close to rotating parts such as the fan may cause your hands or clothes (especially a necktie or scarf) to become caught and result in a serious injury.
- After connecting the charging cable, confirm that it is not wound around anything.
- If the power indicator on the CCID (Charging Circuit Interrupting Device) does not illuminate after plugging the AC charging cable into the outlet, unplug it immediately.

■ **If the error warning indicator on the CCID (Charging Circuit Interrupting Device) illuminates or flashes during charging**

There may be an electrical leakage in the power source path, or there may be a malfunction in the AC charging cable or CCID (Charging Circuit Interrupting Device).

Refer to P.90 and follow the correction procedure. If the error warning indicator does not turn off even after performing the correction procedure, immediately stop charging, remove the AC charging cable and contact your Toyota dealer. Continuing to charge the vehicle in that condition may lead to unforeseen accidents or serious injury.

⚠ WARNING**■ Onboard traction battery charger**

The onboard traction battery charger is located in the motor compartment. Make sure to observe the following precautions regarding the onboard traction battery charger. Failure to observe these precautions may result in death or serious injury such as burns and electric shocks.

- The onboard traction battery charger is hot during charging. Do not touch the onboard traction battery charger, as doing so may result in burns.
- Do not disassemble, repair or modify the onboard traction battery charger. When the onboard traction battery charger needs to be repaired, consult your Toyota dealer.

⚠ NOTICE**■ When charging**

Do not insert the plug into the AC charging inlet. The AC charging inlet may be damaged.

■ Using private power generator

Do not use private power generators as a power source for charging. Doing so may make charging unstable, the voltage may be insufficient, and the charging operation may stop.

■ Charging station

Due to the environment in which the power equipment is located, charging may be unstable due to noise, the voltage may be insufficient, and the charging operation may stop.

After charging

- 1 Unlock the doors to unlock the charging connector.
(→P.93)

The charging connector will be unlocked and the AC charging inlet light will illuminate when the doors are unlocked.

- 2 Pull the charging connector towards you while pressing the latch release button.

If the latch release button is pressed during charging (while the charging indicator is illuminated), charging will be interrupted.

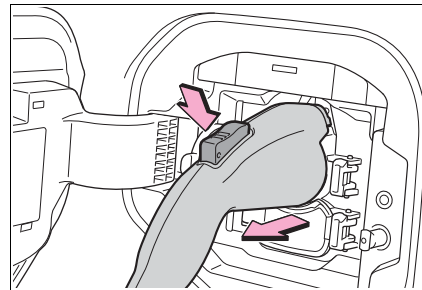

- 3 Attach the charging connector cap.

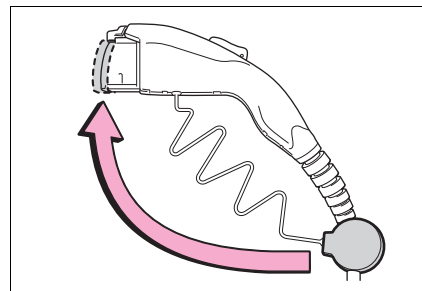

2

Electric Vehicle system

112 2-2. Charging

- 4 Close the AC charging inlet cap and close the charging port lid.

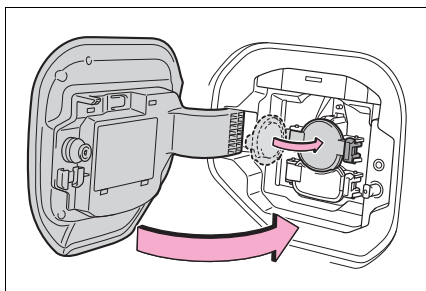

- 5 Remove the plug from the outlet when the charging equipment will not be used for a prolonged period of time.

Hold the body of the plug when removing.

Make sure to put the cable away immediately after disconnecting. (→P.112)

When leaving the plug inserted, inspect the plug and connector once a month to check if dirt or dust has accumulated.

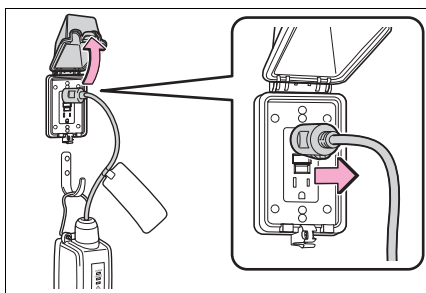

■ When the outside temperature is low or high

The level shown on the SOC (State of Charge) gauge (→P.152) may drop slightly when the power switch is turned to ON, even if charging has been completed and the traction battery is fully charged. How-

ever, this does not indicate a malfunction.

■ When removing the charging connector

Press the latch release button, check that the lever raises up, and then pull the charging connector towards you.

If the lever does not raise up even after the latch release button is pressed, the charging connector is locked. If this occurs, unlock the doors using the smart key system or wireless remote control to unlock the charging connector. (→P.167)

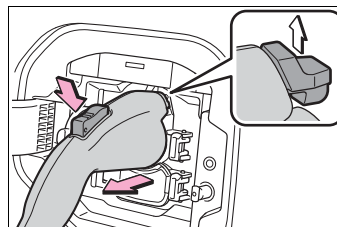

■ If the charging connector cannot be unlocked

→P.95

⚠ WARNING

■ After charging

Remove the plug if it will not be used for a long time.

Dirt and dust may accumulate plug or outlet, which could cause a malfunction or fire, possibly leading to death or serious injury.

⚠ NOTICE

■ After charging

- Store the AC charging cable out of reach from infants and children.

**NOTICE**

- After removing the plug from the outlet, keep it in a safe place free from moisture and dust. The AC charging cable or plug may be damaged if the cable is stepped on or ridden over by the vehicle.
- After disconnecting the charging connector from the AC charging inlet, make sure to close the AC charging inlet cap and close the charging port lid. If the AC charging inlet cap is left open, water or foreign objects may enter the AC charging inlet, which could lead to vehicle damage.

How to use DC charging

This section explains the DC charging procedure for the traction battery.

When using a DC charger, make sure to check the operation instructions of the DC charger.

**WARNING****When using a DC charger**

Observe the following precautions. Failure to do so may cause an unexpected accident, resulting in death or serious injury.

- Use a SAE J 1772 compliant DC charger.
- Do not use the charging cable longer than 30 meters.

Confirm the following before charging

→P.102

When charging

- 1** Open the charging port lid. (→P.85)

The charging inlet light will illumi-

2

Electric Vehicle system

nate.

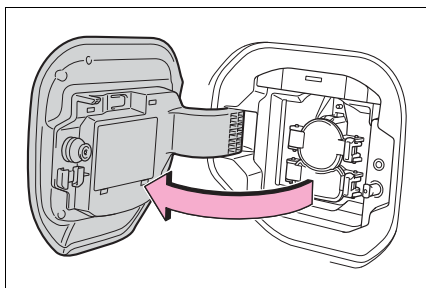

- 2 Open the AC charging inlet cap, and then open the DC charging inlet cap.

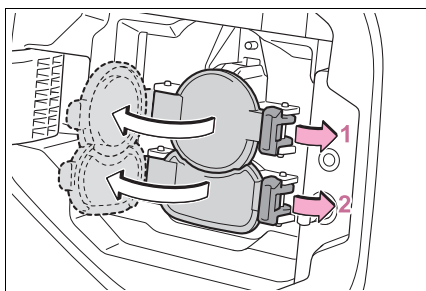

- 3 Insert DC charging connector firmly and fully into the charging inlet

Insert the DC charging connector and it will lock automatically.

The DC charging connector shape and treatment will differ depending on the type of DC charger. Perform the operations in accordance to handling procedures of the DC charger.

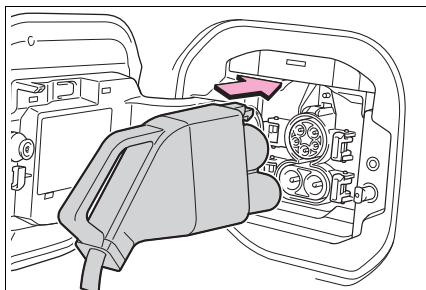

- 4 Operate the DC charger and start the charging.

Follow the handling procedures of the DC charger to start charging.

Charging starts after a system check is done.

- 5 Confirm that the charging indicator on the charging port lights up.

When the charging indicator is not lit, charging has not started.

Stop the charging in accordance to the handling procedures of the DC charger when it is desired to interrupt the DC charging.

■ **Charging time may increase when**

→P.104

■ **When the DC charging connector cannot be inserted into the DC charging inlet**

→P.95

■ **If a message indicating vehicle error on the DC charger side is displayed**

Even if a message indicating vehicle error on the DC charger side (ex. vehicle error found, vehicle error occurred, etc.) is displayed, there is no vehicle fault but possibly a communication error between the DC charger and vehicle. In this case, there may be terminal damage (bad contact) in the DC charging connector. If there is no error with the vehicle, contact the facility manager of the DC charger.

■ **During DC charging**

- The current charging condition can be checked on the multi-information display.
- The actual charging time may differ from that displayed on the DC charger during charging.
- There may be occasions the radio

cannot be heard due to noise occurrence during DC charging

- As the battery approaches full charge, the charging speed will decrease and it will take longer to complete charging.
- The time to complete charging may change, or charging may stop before reaching the upper limit of the charge capacity, due to the remaining charge of the traction battery, the outside temperature, the specifications of the charger (stand), etc.
- It is recommended to avoid frequent DC charging to prevent a decline in the traction battery capacity.
- Quickly move from the DC charging space for other users after the DC charging is completed.

■ **How to set the DC charging power**

You can change the DC charging power limit on the multi-information display or multimedia.

- Setting operations on multi-information display
 - 1 Press or of the meter control switches to select .
 - 2 Press or of the meter control switches to select "Vehicle Settings", and then press and hold OK .
 - 3 Press or of the meter control switches to select "Charging Settings", and then press OK .

The "Charging Settings" screen will be displayed.

 - 4 Press or of the meter control switches to select "DC

charging power", and then press OK .

The "DC charging power" screen will be displayed.

- 5 Press or of the meter control switches to select the charging power from "MAX", "125kW", "100kW", "75kW", "50kW" and then press OK .

*The maximum power when charging is limited to the selected power or less.

If "MAX" is selected, the vehicle will be charged with the maximum power that can be charged.

● Setting operations on multimedia

- 1 Select .
- 2 Select "Vehicle customize".
- 3 Select "Charging".
- 4 Select "DC charging power".
- 5 Select from "MAX", "125kW", "100kW", "75kW", "50kW".

*The maximum power when charging is limited to the selected power or less.

If "MAX" is selected, the vehicle will be charged with the maximum power that can be charged.

■ **Changing the "Charging Limit" settings**

→P.108

■ **If "Check Charging System Close Charging Port Lid See Owner's Manual" is displayed on the multi-information display**

If the system check after DC charging is not completed successfully, the EV system will not start even if the power switch is pressed while depressing the brake pedal.

Perform a system check with the following procedures.

- 1 Be sure to engage the parking brake and then turn the power switch off.
- 2 Close the charging inlet cap, close the charging port lid.
- 3 Check if “Checking Charging System” is displayed on the multi-information display when the power switch is turned to ON.

Do not open the charging port lid while the charging system is checking.

When the system check is completed, the power switch automatically turns off.

- 4 Press the power switch while depressing the brake pedal. The “READY” indicator turns on.

Contact your Toyota dealer if the charging system check is done and the message on the multi-information display does not go off.

 **WARNING**

■ **Warnings for DC charging**

Be sure to observe the following when using DC charging.

Failure to do so may cause an accident that could lead to death or serious injury.

- Check that the DC charger and DC charging inlet are not damaged. If there is any damage to the DC charging inlet, do not perform a DC charge and have it inspected immediately at your Toyota dealer.
- Do not touch the terminals of the DC charging connector or inlet with metallic sharp tips (wires and needles), or allow a short circuit to occur with foreign objects.
- Do not insert anything other than the DC charging connector into the DC charging inlet.

- Check that the DC charging cable is not coiled up or pinned underneath heavy objects.

- Be sure the DC charging inlet makes direct contact with the DC charging connector. Do not connect conversion adapters, extension cords, etc., between the DC charging connector and DC charging inlet.

- When DC charging is interrupted, follow the handling procedures of the DC charger. Immediately stop the DC charging when there is an outbreak of heat, smoke, strange noises or smells, etc., during charging.

- Check that the DC charging connector and DC charging inlet do not have foreign objects or snow or ice attached to it. If anything is attached to the inlet, be sure to completely remove the material before connecting the DC charging connector.

- Do not charge the vehicle when there is a possibility of lightning. If you notice lightning while charging the vehicle, do not touch the vehicle and the DC charging cable.

- Do not get the DC charging inlet terminals wet.

- Close the hood when using DC charging. The cooling fan may suddenly start to run. Keep hands and clothing (especially a tie, a scarf or a muffler) away from the fan. Failure to do so may cause the hands or clothing to be caught, resulting in serious injury.

⚠ WARNING**■ When connecting the DC charging connector**

- Follow the handling procedures of the DC charger to connect the DC charging connector. If the connector is not connected properly, the system cannot recognize the connection, and it may be possible to start the EV system.

After charging is completed, make sure to remove the DC charging connector from the DC charging inlet before starting the EV system.

If the vehicle is started off with the connector still connected, it could lead to an accident, possibly resulting in death or serious injury.

- Do not remove the DC charging connector from the DC charging inlet during DC charging. After operating the DC charger to stop charging, remove the DC charging connector from the DC charging inlet.

⚠ NOTICE**■ When using DC charging**

Make sure to follow the handling procedures of the DC charger. If the procedures are not followed properly, the vehicle and the DC charger may be damaged.

After charging

- 1 Operate the DC charger to stop the charging.

DC charging connector will be unlocked automatically when charging is completed.

- 2 Remove the DC charging connector.

The DC charging connector shape and treatment will differ depending on the type of DC charger. Perform the operations in accordance to handling procedures of the DC charger.

Return the removed DC charging connector to its original position.

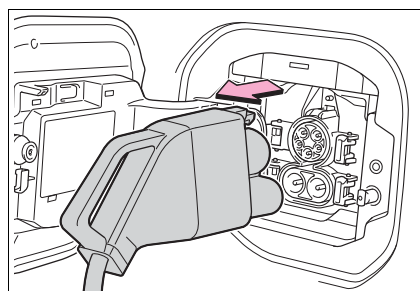

- 3 Close the AC charging inlet cap and close the DC charging inlet cap, and then close the charging port lid.

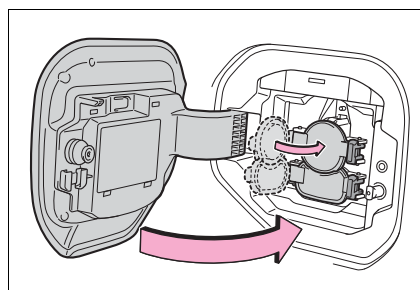
**■ When DC charging cannot be stopped**

If charging cannot be stopped from the DC charger side due to a malfunction, etc.

You can also stop DC charging by pressing the door unlock button (on the electronic key, or driver's door) three times at 1 to 2 seconds intervals.

2

Electric Vehicle system

■ **If the DC charging connector cannot be unlocked**

→P.95

■ **After DC charging**

Even if the traction battery is charged to the upper limit value that is set, the level of charge displayed on the DC charger may be lower than the actual one.



NOTICE

■ **Caution after DC charging**

- Be sure to attach the DC charging inlet cap to the DC charging inlet and then close the charging port lid after removing the DC charging connector from the inlet. If the DC charging inlet cap is not closed, foreign materials may get into the inlet and the EV system may be malfunctioning.

Using the charging schedule function

AC charging can be carried out at the desired time by registering the charging schedule.

■ **Calendar settings**

Charging schedule is performed according to the date and time shown on the multi-information display. Refer to the “Settings display” (→P.158)

If the calendar settings check screen is displayed when an attempt was made to register a charge schedule, check that the correct date is set. If it is incorrect, be sure to correct it.

If the calendar information is wrong, the charging schedule function will not operate normally.

Settings of the charging schedule function

When registering the charging schedule, the following settings can be changed.

■ **Select the charging mode**

One of the two following charging modes can be selected.

▶ **“Start”**

Starts charging at the set time* and finishes charging when fully charged.

▶ **“Start-Stop”**

AC charging is performed

according to the set start time and stop time.*

*: There might be a slight error in the timing when charging starts due to the state of the traction battery.

■ Repeated setting

The periodic charging schedule can be set by selecting your desired day of the week. Select one or more day of the week to do the charging schedule.

■ Turning “Charge Now” on and off

To start charging without changing the charging schedule setting, turn “Charge Now” on to temporarily cancel the charging schedule and enable charging after connecting the AC charging connector.*

*: If the charging connector is removed during charging while the charging schedule is registered and “Charge Now” is on, “Charge Now” turns off.

■ “Next Event”

Of the registered charging schedules, the closest charging schedule after the current time is called the “Next Event”.

For charging schedule, AC charging will be performed according to the Next Event.

Registering the charging schedule

The charging schedule can be registered on the multi-information display or multimedia.

- Multi-information display operation: →P.121
- Multimedia operation: →P.125

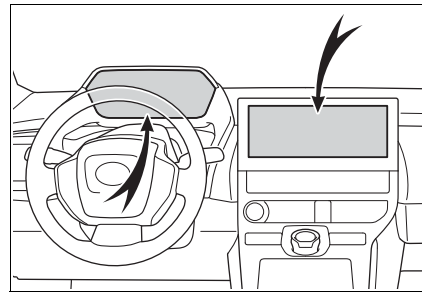

■ Charging schedule

- The charging schedule cannot be set while driving.
- A maximum of 15 charging schedules can be registered.

If the charging mode is set to “Start-Stop” and the start time and stop time are set to the same time, charging will be performed for 24 hours from the start time.

The charging schedule function can not be used when using DC charging.

■ To make sure that the charging schedule function operates correctly

Check the following items.

- Adjust the clock to the correct time (→P.158)
- The calendar is set to the correct date (→P.158)
- Check that the power switch is turned off
- After registering the charging

schedule, connect the AC charging connector

The charging start time is determined based on the charging schedule at the time that the AC charging connector was connected.

- Connect the AC charging connector before the start time

When the charging mode is set to “Start”, if you connect the AC charging connector after the set start time, the next charging schedule will be referenced.

When the charging mode is “Start-Stop”, if you connect the AC charging connector after the start time, charging will start immediately and charging will be performed until the stop time.

- After connecting the AC charging connector, check that the charging indicator of the charging port flashes (→P.86)
- Do not use an outlet that has a power cut off function (including a timer function)

Use an outlet that constantly supplies electricity. For outlets where the power is cut off due to a timer function, etc., charging may not be carried out according to plan if the power is cut off during the set time.

■ When the AC charging connector remains connected to the vehicle

- When the charging mode is set to “Start”, even if multiple consecutive charging schedules are registered, the next charge will not be carried out according to the charging schedule until the AC charging connector is removed and reconnected after charging completes. Also, when the traction battery is fully charged, charging according to the charging sched-

ule will not be carried out.

- If the charging stop time is reached before the traction battery is fully charged and the charging mode is set to “Start-Stop”, the nearest charging schedule after the stop time is updated as the next charging schedule, and charging is repeated until the battery is fully charged.

■ Smartphone-linked operation

After applying to Toyota App, it is possible to use the smartphone application to change charging schedule settings.

For details about Toyota Apps, refer to <http://www.toyota.com/connected-services> in the United States and <http://www.toyota.ca/connected> in Canada.

■ When charging schedules are ignored

When the following operations are performed while the charging schedule is on standby, charging schedule is temporarily canceled and charging is started.

- When the Remote Air Conditioning System (→P.409) is operated
- When turning “My Room Mode” on (→P.129)
- When turning “Charge Now” on (→P.124, 128)
- When an operation that temporarily cancel charging using the charging schedule (→P.107)

■ Battery heater (→P.99)/“Battery Cooler” (→P.99)

Depending on the temperature of the traction battery, the traction battery heater or traction battery cooler may be activated and the charging indicator may light up while the timer is waiting for charging.

Setting operations on multi-information display

When operating charging schedule, use the meter control switches.

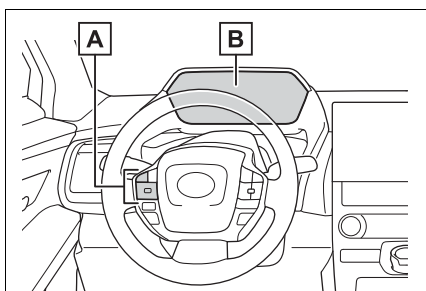

A Meter control switches
(→P.156)

B Multi-information display

■ Registering the charging schedule

- 1 Press \wedge or \vee of the meter control switches to select .
- 2 Press \leftarrow or \rightarrow of the meter control switches to select “Vehicle Settings”, and then press and hold OK.
- 3 Press \wedge or \vee of the meter control switches to select “Charging Settings”, and then press OK.

The “Charging Settings” screen will be displayed.

- 4 Press \wedge or \vee of the meter control switches to select “Charging Schedule”, and then press OK.

The “Charging Schedule” screen will be displayed.

- 5 Press \wedge or \vee of the meter control switches to select “Scheduled Events”, and then press OK.

The “Scheduled Events” screen will be displayed.

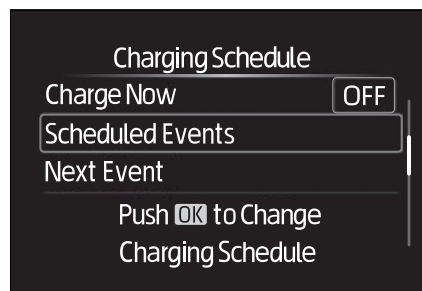

- 6 Press \wedge or \vee of the meter control switches to select “+add”, and then press OK.

The “Charging Mode” screen will be displayed.

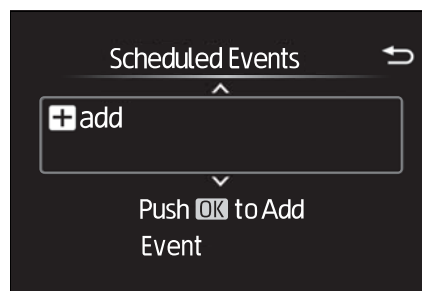

- 7 Press \wedge or \vee of the meter control switches to select the item to change with the cursor, and then press \leftarrow or \rightarrow to change the setting.

When the charging mode is “Start”, set the charging start time.

When the charging mode is “Start-Stop”, set the charging start time and stop time.

After changing the settings to the desired settings, press

OK.

- 8 Press \wedge or \vee of the meter control switches to select the desired day to activate for the repeated setting, and then press OK.

Each time OK is pressed, the repeated setting switches between on and off.

When set to on, the charging schedule is repeated on that day. It is possible to set more than one day to on.

After changing the settings to the desired settings, select “Done”, and then press OK.

A screen where the settings can be saved will be displayed.

- 9 Select “Save” and press OK to save the settings. The settings will be saved. If you wish to change the settings, press \leftarrow and perform the setting procedure again. After setting operations are complete, when the AC charging connector is connected to the vehicle, charging will be carried out according to the charging schedule settings.

■ Switching charging schedules between on and off

The registered charging schedules can be turned on and off.

- 1 Perform step 1 to 5 of the “Registering the charging schedule” procedure (\rightarrow P.121) and display “Scheduled Events” screen.

A list of the registered charging schedule will be displayed.

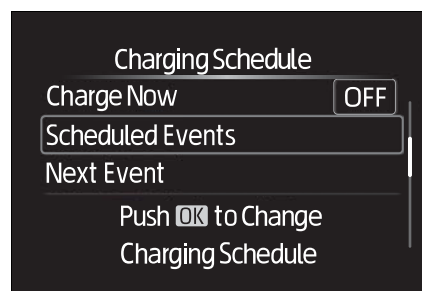

- 2 Press \wedge or \vee of the meter control switches to select the item to turn ON/OFF, and

then press OK .

Each time OK is pressed, the selected charging schedule switches between on and off. When set to off, a charging schedule is ignored and charging according to the charging schedule is not carried out.

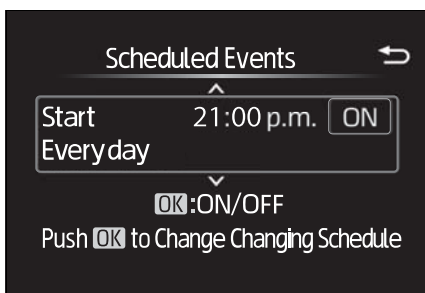

■ **Changing the registered charging schedules**

The registered charging schedules can be modified or deleted.

- 1 Perform step 1 to 5 of the “Registering the charging schedule” (→P.121) procedure and display “Scheduled Events” screen.

A list of the registered charging schedule will be displayed.

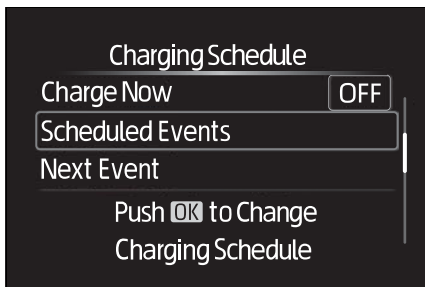

- 2 Press ^ or v of the meter control switches to select the item to change, and then press and hold OK .

The “Edit Event” screen will be displayed.

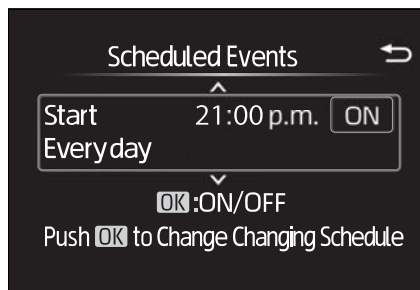

- 3 Press ^ or v of the meter control switches to select the item to operate, press OK and perform the necessary operation.

● “Edit”

Change the desired settings as described starting from step 7 of the “Registering the charging schedule” procedure. (→P.121)

Press ↩ to return to the previous screen.

● “Delete”

A deletion confirmation screen will be displayed.

Press ^ or v of the meter control switches to select “Yes”, and then press OK to delete the selected charging schedule.

To cancel deletion, select “No” and



then press OK .

Press  to return to the previous screen.

■ Setting “Charge Now” to on

The “Charge Now” setting can be changed by performing one of the two following procedures.

▶ Operation on “Charging Schedule” screen

- 1 Perform step 1 to 4 of the “Registering the charging schedule” procedure (→P.121) and display “Charging Schedule” screen.
- 2 Press  or  of the meter control switches to select “Charge Now”, and then press OK .

Each time OK is pressed, “Charge Now” switches between on and off.

▶ Operation on “Closing Display” screen *

*: If “Closing Display” is not set to “Charging Schedule” on the  screen of the multi-information display, the “Closing Display” is not displayed. In this case, check the settings on the multi-information display.

- 1 Turn the power switch off. The “Closing Display” screen is displayed on the multi-



information display.

(If the door is opened while waiting for charging schedule, the same screen will be displayed.)

- 2 Press OK to set “Charge Now” to on.

After setting operations are complete, charging starts when the AC charging connector is connected.

■ Displaying “Next Event”

- 1 Perform step 1 to 4 of the “Registering the charging schedule” procedure (→P.121) and display “Charging Schedule” screen.
- 2 Press  or  of the meter control switches to select “Next Event”, and then press OK .

The “Next Event” screen will be displayed.

■ When charging schedule setting operations are canceled

When the vehicle is in the following conditions, charging schedule setting operations are canceled.

- The power switch is operated before the settings are confirmed
- The vehicle starts off
- A display with a higher priority than that of the charging schedule setting is shown

NOTICE
 While performing the setting operation
 When performing the setting operation while the EV system is stopped, be careful that the 12-volt battery will not be discharged.

Setting operations on multimedia

For details on how to operate the audio system screen, refer to "MULTIMEDIA OWNER'S MANUAL".

Setting operations related to the charging schedule are performed on the "Charging schedule" screen.

■ Displaying the "Charging schedule" screen

1 Turn the power switch ON and display the menu screen.

It is not possible to control the

■ How to read the "Charging schedule" screen

Charging Schedule settings in Accessory Mode.

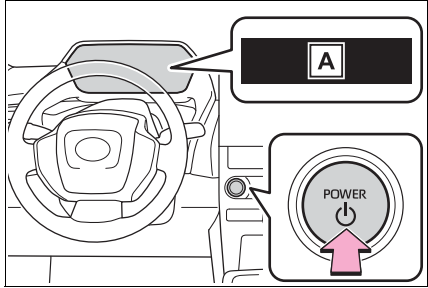

A "POWER ON"

2 Select and "Charging schedule", in that order. The "Charging schedule" screen will be displayed.

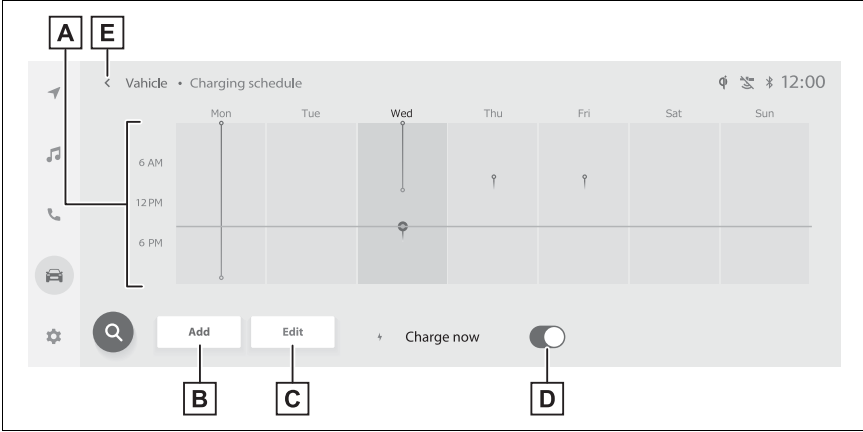
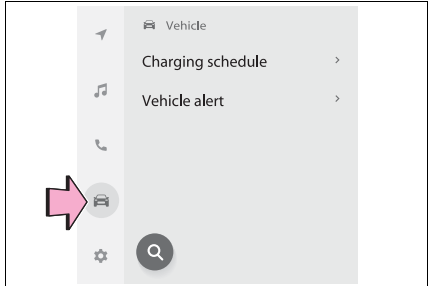

A Charging schedules

Displays the week-long registered charging schedule in a list using icons.

B “Add” button

Press to add a new item to the charging schedule. (→P.126)

C “Edit” button

Press to change or delete registered items on the charging schedule. (→P.127)

D “Charge now” button

Each time the button is pressed, “Charge now” switches between on and off. (→P.128)

E Return button

Press to close the “Charging schedule” screen.

■ Registering the charging schedule

press “OK”.

1 Display the “Charging schedule” screen. (→P.125)

2 Press “Add”.

The “Add event” screen will be displayed on the screen.

3 Change the schedule to the desired time.

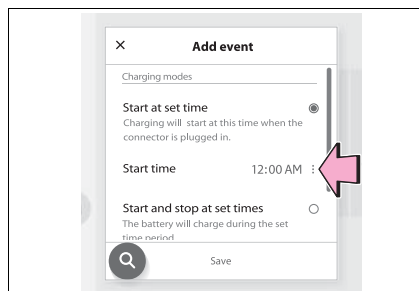

● Charging mode

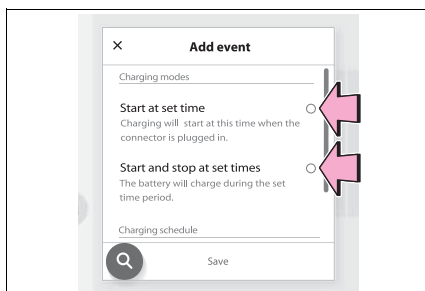

Press “Start at set time” or “Start and stop at set times” to set the desired charging mode.

- When “Start at set time” is selected

Set the charging start time, and

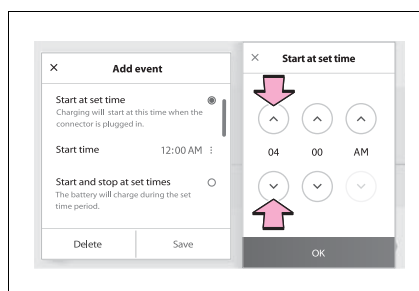

- When “Start and stop at set times” is selected

Set the charging start time and stop time, and press “OK”.

● Repeated settings

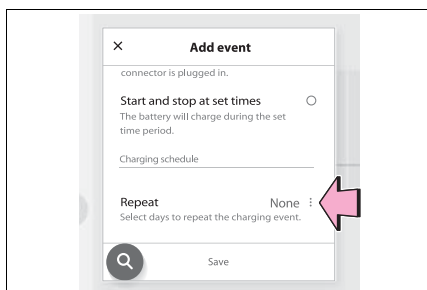

Select the day of the week and press OK.

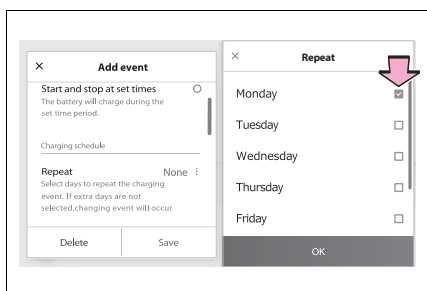

When turned on, the charging schedule is repeated on that day. It is possible to turn more than one day on.

4 After setting operations are complete, press “Save”.

The charging schedule is registered and an icon is added to the schedule.

To cancel registration of the charging schedule, press the return button.

After setting operations are complete, when the power switch is turned off and the AC charging connector is connected to the vehicle, charging is carried out according to the

charging schedule settings.

■ Switching charging schedules between on and off

- 1 Display the “Charging schedule” screen. (→P.125)
- 2 Press “Edit”.

The “Events” screen will be displayed on the screen.

- 3 From the items displayed on the screen, press on or off in the row of the charging schedule you wish to change.

If the charging schedule you wish to change is not displayed on the screen, scroll the list up and down to display it.

Each time the button is pressed, the charging schedule switches between on and off.

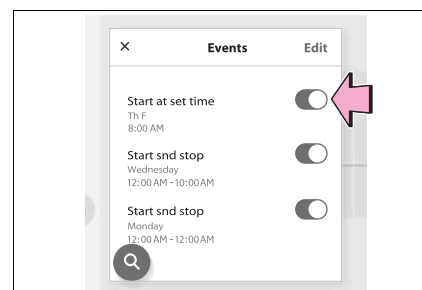

■ Changing the registered charging schedules

- 1 Display the “Charging schedule” screen. (→P.125)
- 2 Press “Edit”.

The “Events” screen will be displayed on the screen.

- 3 Press “Edit” on the “Events” screen.

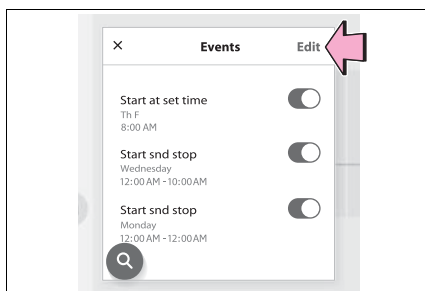

- 4 From the items displayed on the screen, press the charging schedule you wish to change.

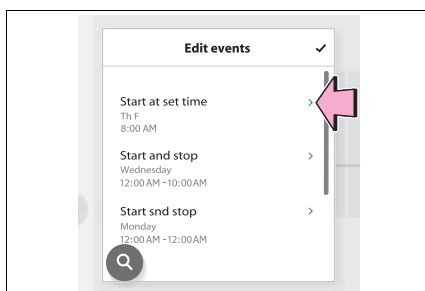

- Changing registered items:
Change the desired settings as described in step 3 to step 4 of the “Registering the charging schedule” procedure. (→P.126)
When a setting is changed, its icon on the calendar also changes.

- Deleting registered items:
Press “Delete”.

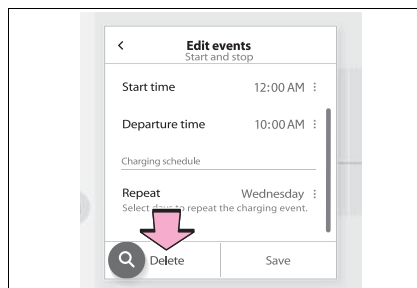

A deletion confirmation message will be displayed.

Press “Delete” to delete the selected charging schedule.

To cancel deletion, press “Cancel” or the return button.

When a charging schedule is deleted, its icon is also deleted from the calendar.

■ Turning “Charge now” on

- 1 Display the “Charging schedule” screen. (→P.125)
- 2 Press “Charge now”.

Each time the button is pressed, “Charge now” switches between on and off.

After setting operations are complete, charging starts when the AC charging connector is connected.

■ Changing Next Event

If the multimedia customize content “ACC customize” is not set to OFF, the ending screen will not be displayed. If it is this case, check the settings of the multimedia.

Turn the power switch off.

Next event will be displayed according to the charging schedule settings.

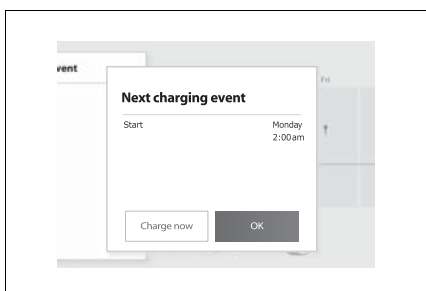

When press “OK”, close Next charging event screen.

When press “Charge Now”, charge now is turned on.

■ When all charging schedules are turned off

The icon is not displayed on the “Charging schedule” screen.

The icon will be displayed by turning it ON on the “Events” screen.

■ When charging schedule setting operations are canceled

When the vehicle is in the following conditions, charging schedule setting operations are canceled.

- The power switch is turned off before the settings are confirmed
- The vehicle starts off
- A display with a higher priority than that of the charging schedule setting is shown

 **NOTICE**

■ While performing the setting operation

When performing the setting operation while the EV system is stopped, be careful that the 12-volt battery will not be discharged.

Using My Room Mode

When the charging cable is connected to the vehicle, electrical components such as the air conditioning system and audio system can be used by the power supply from an external power source.

Starting My Room Mode

- 1** Connect the charge cable to the vehicle to start charging.

AC Charging: →P.105

DC Charging: →P.113

- 2** Turn the power switch to ON while charging.

My Room Mode settings is automatically displayed on the multi-information display.

- 3** Operate the meter control switches to select “Yes”, and then press “OK”.

My Room Mode is started and it is possible to use the air conditioning system, audio system, etc.

Select “No” and press “OK” when My Room Mode is not being used.

To disable My Room Mode, turn the power switch off.

My Room Mode will automatically be off when DC charging is completed.

Display information for electric power balance during My Room Mode

When starting My Room Mode,

2
Electric Vehicle system

the electric power balance will be automatically displayed on the multi-information display, and an approximation of the electricity balance (the balance between the amount of electricity provided and electricity consumed) during My Room Mode can be checked.



A Discharging (-)

B Charging (+)

The size of the arrow symbol changes depending on the power supply and electricity consumption amounts.

If the electricity consumption is more than the power supply, **A** is displayed more than **B**.

If the power supply and electricity consumption amounts are equal, **A** and **B** are displayed as the same size.

■ Meter display while charging

After turning the power switch to ON while charging, the power switch automatically turns off if My Room Mode is not selected within approximately 100 seconds.

■ When using My Room Mode the following may occur

- When the remaining charge of the traction battery drops to the lower limit, the air conditioning system automatically stops. In that case, the air conditioning system can not operate until the remaining charge of the traction battery increases. Turn off the power switch once, then use My Room Mode after the remaining charge of the traction battery increases.
- The charging time of the traction battery gets longer.
- Noise may be heard from the radio depending on conditions of the radio wave.
- The surrounding area of the onboard traction battery charger in the motor compartment may become hot.
- The electric power steering system warning light (yellow) may turn on, but this is not a malfunction.

■ Using My Room Mode during DC charging

When using My Room mode during DC charging, the state of charge completion will be lower than when not using My Room Mode.

■ When “My Room Mode” is used while the traction battery is fully charged

When the power switch is turned on while the traction battery is fully charged and the charging connector that supplies power is connected, “Charging Port Lid is Open” is displayed on the multi-information display. In this case, press  on the meter control switches to display the setting screen of “My Room Mode”, and then select “My Room Mode”.

When “My Room Mode” is used while the traction battery is fully charged, the electric power of the

traction battery may be consumed. In this case, charging may be per-
formed again.

■ **Warning message display**

When trying to start My Room Mode or My Room Mode is being used, if a message is displayed on the multi-information display, refer to the corresponding table and perform the appropriate correction procedures.

| Message | Correction procedure |
|--|--|
| “Traction Battery is too Low for “My Room Mode”” | There is no remaining charge of the traction battery to start My Room Mode. Wait until the remaining charge of the traction battery increases, start My Room Mode. |
| ““My Room Mode” has stopped due to low traction battery level” | The remaining charge of the traction battery is insufficient. Stop using My Room Mode and charge the traction battery. |
| ““My Room Mode” will stop when traction battery level is too low Reduce power usage to continue using “My Room Mode”” | When My Room mode electricity consumption exceeds the charge amount, the traction battery charge level becomes too low.* <ul style="list-style-type: none"> • If the electricity consumption of the vehicle can not be improved, My Room Mode will be off. • When My Room Mode continuation is desired, turn off the air conditioning system, audio system, etc., to increase the remaining charge of the traction battery. |

*: During My Room Mode, the information for electric power balance can be checked on the multi-information display.



WARNING

■ **Warnings for using My Room Mode**

Observe the following precautions.

Failure to do so may result in death or a serious health hazard.

- Do not leave children, people who need care, or pets inside the vehicle. The temperature inside the vehicle may become high or low due to features such as the automatic shut-off. The children, people who need care, or pets left inside the vehicle may suffer heatstroke dehydration or hypothermia. Also, since the wipers, etc., can be operated, there may be accidental operation, possibly leading to an accident.
- Use the mode after sufficiently checking the vicinity of the vehicle for safety hazards.

When charging cannot be carried out

When charging does not start, even though the normal procedure is followed, check each of the following items. If a message is shown on the multi-information display, also refer to P.140.

When charging cannot be carried out

Refer to the following table and carry out the appropriate correction procedure.

■ **The error warning indicator on the CCID (Charging Circuit Interrupting Device) flashes**

| Likely cause | Correction procedure |
|---|--|
| Electrical leakage detection function or self-diagnostic function operates and power is cut off | When the voltage is insufficient, the error warning indicator may flash when there is noise interference. Perform a reset and connect to a proper power source. (→P.90) If charging does not start, immediately stop charging and contact your Toyota dealer. |

■ **Charging indicator of the charging port does not illuminate, even though charging connector is connected.**

| Likely cause | Correction procedure |
|--|--|
| Plug is not properly connected to outlet | Check that the plug is properly connected to the outlet. |
| Power is out | After power is restored, carry out the charging procedure again. |
| Remote switch is off | If the remote switch is equipped, turn the switch on. |

2
Electric Vehicle system

| Likely cause | Correction procedure |
|--|---|
| Building breaker is tripped and power is cut off | <p>Check that the breaker is connected and if there is no malfunction, check if the vehicle can be charged through another outlet.</p> <p>If charging is possible, the first outlet may have a malfunction. Contact the building or facility manager, or an electrician.</p> |
| Short circuit between CCID (Charging Circuit Interrupting Device) and plug | Immediately stop charging and contact your Toyota dealer. |
| AC charging connector is not securely connected to AC charging inlet | <p>Check the connection status of the AC charging connector.</p> <ul style="list-style-type: none"> • When connecting the AC charging connector, make sure not to touch the latch release button. Insert the AC charging connector securely until you hear a click. The AC charging connector may not be connected correctly if the latch release button is pressed while inserting. • After connecting the AC charging connector, check that the latch release button is not pressed and the charging indicator of the charging port is turned on. <p>If the charging indicator of the charging port does not illuminate, even though the AC charging connector is securely connected, there may be a malfunction in the system. Immediately stop charging and contact your Toyota dealer.</p> |
| Traction battery is already fully charged | When the traction battery is fully charged, charging is not performed. |
| The AC charger does not operate | Please contact the facility manager when there is a problem with AC charger. |

■ **Charging indicator of the charging port flashes and charging cannot be carried out.**

| Likely cause | Correction procedure |
|---|--|
| When charging indicator of the charging port flashes normally* : Charging schedule is registered | When you wish to charge according to the charging schedule, wait until the set time. To start charging, set "Charge Now" to on. (→P.124, 128) |
| When charging indicator of the charging port rapidly flashes* : Malfunction occurred in an external power source or the vehicle | A message will be displayed on the multi-information display when the power switch is off. Follow the instructions displayed on the multi-information display. |

*: Refer to P.86 for details regarding charging indicator of the charging port illumination and flashing.

When DC charging cannot be performed normally

■ **DC charging does not start**

| Likely cause | Correction procedure |
|---|--|
| The DC charging connector is not properly connected to the vehicle. | Check the connection status of the DC charging connector and be sure that it is locked. If the DC charging does not start, even though the DC charging connector is securely connected, there may be a malfunction with the DC charger or charging system. |
| The DC charging connector is not securely locked. | <ul style="list-style-type: none"> • If there is a malfunction with the DC charger, contact the charging station manager. • If there is not a malfunction with the DC charger, there may be a malfunction in the system. Contact your Toyota dealer. |

| Likely cause | Correction procedure |
|--|--|
| Error is detected by the DC charger or vehicle's system check. | <p>There may be a malfunction with the DC charger or charging system.</p> <ul style="list-style-type: none"> • If there is a malfunction with the DC charger, contact the facility manager. • If there is not a malfunction with the DC charger, there may be a malfunction in the system. Contact your Toyota dealer. • If the EV system can not be started, contact your Toyota dealer. |
| The DC charger power goes off. | Contact the charging station manager and check the power status. |
| Traction battery is already fully charged | When the traction battery is fully charged, DC charging cannot be performed. |
| AC charging connector is also connected. | DC charging and AC charging can not be performed together. |
| The EV system is started. | <p>When the EV system is started, DC charging cannot be started.</p> <p>Also, if the shift position is not in P, DC charging cannot be performed.</p> |

■ When DC charging is interrupted

| Likely cause | Correction procedure |
|--|---|
| The timer for the DC charger operates. | <p>Depending on the type of the DC charger, the timer may be set to stop charging after a certain time.</p> <p>Check with the charging station manager.</p> |
| The power for the DC charger is off. | Check the power status of the DC charger. If there are uncertainties with the power status, contact the charging station manager. |

| Likely cause | Correction procedure |
|---|---|
| The temperature of the traction battery is extremely high or low. | DC charging may not be performed in extremely high or extremely low temperature environments. Charge the traction battery after the temperature has been stabilized. |
| Error is detected by the DC charger or vehicle's system check. | There may be a malfunction with the DC charger or charging system. <ul style="list-style-type: none"> • If there is a malfunction with the DC charger, contact the facility manager. • If there is not a malfunction with the DC charger, there may be a malfunction in the system. Contact your Toyota dealer. • If the EV system can not be started, contact your Toyota dealer. |
| High temperature of charging related parts | If the temperature of charging related parts is high, DC charging may not be possible. Wait for a while and then charge again. |
| The electrical components such as the air conditioning system stop operating while the traction battery is approximately fully charged. | Keep the electrical components such as the air conditioning system in the OFF state, and then perform the charging procedure again. |

■ EV system does not start after DC charging

| Likely cause | Correction procedure |
|--|---|
| System check is not completed properly after charging. | Do a system check following the procedures on P.115. If the system check can not be completed properly even after these procedures are performed, contact your Toyota dealer. |

| Likely cause | Correction procedure |
|---|---|
| The DC charging connector is still connected. | For safety, the EV system can not be started when the DC charging connector is connected. (→P.102) Remove the DC charging connector immediately after the charging is completed. |
| The DC charging system is malfunctioning | <ul style="list-style-type: none"> Depending on the type of malfunction, the EV system can be started after closing the charging port lid. If the EV system can not be started, contact your Toyota dealer. |

When charging schedule function does not operate normally

Refer to the following tables and carry out the appropriate correction procedures.

■ Cannot charge at desired time

| Likely cause | Correction procedure |
|---|---|
| The vehicle calendar and clock are not set correctly. | Check the calendar setting and set it to the correct date. (→P.158) |
| AC charging connector is not connected to vehicle | Before using the charging schedule, connect the AC charging connector. |
| AC charging connector was connected after set time | Connect the AC charging connector before the time set in "Start". When the charging mode is set to "Start-Stop", the traction battery will charge even if the start time has passed, if the AC charging connector is connected before the stop time. |

■ **Charging starts, even though the charging schedule is registered**

| Likely cause | Correction procedure |
|---|---|
| “Charge Now” is set to on | When charging according to the charging schedule, set “Charge Now” to off. (→P.124, 128) |
| Charging schedule is set to off | Check that charging schedule is not set to off. (→P.118) |
| AC charging connector was removed and reinserted while charging indicator of the charging port was flashing | If the AC charging connector is removed and reinserted while the charging indicator is flashing, the charging schedule is canceled. Temporarily remove the AC charging connector, and then reconnect it. |
| The Remote Air Conditioning System was operated | When the Remote Air Conditioning System is operated, the system will start charging, even if the charging schedule is registered. To carry out charging using the charging schedule, stop the Remote Air Conditioning System, and then reconnect the AC charging connector. |
| Outside temperature is low and traction battery warming control (→P.99) operated | <ul style="list-style-type: none"> • When traction battery warming control operates, the charging schedules are ignored and charging starts. In order to protect the traction battery, allow charging to continue. • After removing and installing the 12-volt battery, the charging schedule setting may become invalid due to the initial setting of the traction battery warming control system even when the outside temperature is not low. In this case, after a few runs, the system’s initial settings will be completed and the charging schedule settings will take effect when the outside temperature is not low. |

When charging related message is displayed

When a door is opened with the power switch off, after charging, a message is displayed in the multi-information display.

When this occurs, follow the instructions displayed on the screen.

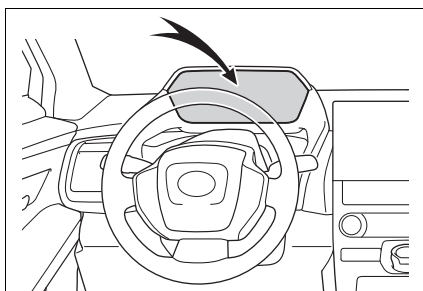

■ If “Charging Stopped Due to Pulled Charging Connector” is shown

| Likely cause | Correction procedure |
|--|---|
| AC charging connector is removed while AC charging | When the AC charging connector is removed while AC charging, charging stops. If you want to fully charge the traction battery, reconnect the AC charging connector. |
| After the traction battery is fully charged, the AC charging connector is removed while the traction battery is being recharged again because electricity-consuming functions* have been used and the remaining charge is now reduced. | |

| Likely cause | Correction procedure |
|---|--|
| AC charging connector is not securely connected | <p>Check the connection status of the AC charging connector.</p> <ul style="list-style-type: none"> When connecting the AC charging connector, make sure not to touch the latch release button. Insert the AC charging connector securely until you hear a click. The AC charging connector may not be connected correctly if the latch release button is pressed while inserting. After connecting the AC charging connector, check that the latch release button is not pressed and the charging indicator of the charging port is turned on. <p>If charging cannot be carried out, even though the proper procedures were followed, have the vehicle inspected by your Toyota dealer.</p> |
| Latch release button of AC charging connector was pressed while AC charging | When the latch release button is pressed while AC charging, charging stops. To continue charging, reconnect the AC charging connector. |

* : Electricity is consumed when operating battery heater (→P.99), the Remote Air Conditioning System (→P.409).

■ If “Charging Complete Limited Charge Due to Battery Temp” is shown

| Likely cause | Correction procedure |
|--|---|
| Charging was stopped to protect the traction battery as it continued to remain hot for a certain period of time. | Allow the traction battery to cool down and perform charging again if the charging amount has not reached the desired amount. |

■ If “Charging Stopped Check Charging Source” is shown

| Likely cause | Correction procedure |
|---|---|
| <p>Problem in power supply from external power source</p> | <p>Check the following items.</p> <ul style="list-style-type: none"> • The plug is securely inserted. • Extension cord is not used and outlet is not overloaded. • The remote switch is not off. • Connected to a dedicated power line. • Power outage has occurred or not. • The power indicator on the CCID (Charging Circuit Interrupting Device) is illuminated. • The circuit breakers have not tripped. <p>If all of the above conditions are met, the outlet may be malfunctioning. Contact an electrician and request an inspection.</p> <p>Furthermore, if the error warning indicator on the CCID (Charging Circuit Interrupting Device) is flashing, there may be electrical leakage. Contact your Toyota dealer.</p> <p>If charging cannot be performed, even though there is no problem with the power source path, there may be a malfunction in the system. Have the vehicle inspected by your Toyota dealer.</p> |
| <p>Charging is stopped by AC charger</p> | <p>Depending on the specifications of charger, charging may be canceled by an interruption of power supply. Charging may be stopped by the following.</p> <p>Refer to charger handling methods.</p> <ul style="list-style-type: none"> • The charging stop button of charger is pressed. • Charger with off timer function canceled charging • Charger that is not compatible with the charging schedule function of the vehicle • Check if it is possible to charge with the AC charging cable equipped with the vehicle. If charging cannot be carried out even when using the genuine AC charging cable, contact your Toyota dealer. |

| Likely cause | Correction procedure |
|--|---|
| The AC charger is not compatible with the vehicle | Check if it is possible to charge with the AC charging cable equipped with the vehicle. If charging cannot be carried out even when using the genuine AC charging cable, contact your Toyota dealer. |
| The DC charger is malfunctioning. | If the message above is displayed when DC charging has not stopped operations, the DC charger may be damaged, so do not use that DC charger. Check if it is possible to charge with another DC charger. |
| The DC charger is not compatible with the vehicle. | |

■ If “Charging Stopped High Energy Use See Owner’s Manual” is shown

| Likely cause | Correction procedure |
|---|---|
| Power is being consumed by electrical components of vehicle | Check the following items, and then carry out charging again. <ul style="list-style-type: none"> • If the headlights and audio are turned on, turn them off. • Turn the power switch off. If charging cannot be carried out, even after performing the above, the 12-volt battery may not be sufficiently charged. Operate the EV system and wait for approximately 15 minutes or more to charge the 12-volt battery. |

■ If “Charging System Malfunction See Owner’s Manual” is shown

| Likely cause | Correction procedure |
|---|---|
| Malfunction occurred in charging system | Have the vehicle inspected by your Toyota dealer. |

■ If “The Traction Battery Temp is low System put priority on charging to preserve battery condition” is shown

| Likely cause | Correction procedure |
|--|--|
| The traction battery warming control is operated (→P.99) | <p>When the traction battery warming control operates, the charging schedule is not used and charging is performed.</p> <p>This is a control to protect the traction battery, and not a malfunction.</p> |

■ If “Check Charging System Close Charging Port Lid See Owner’s Manual” is shown

| Likely cause | Correction procedure |
|---|--|
| System check is not completed properly after DC charging. | The EV system can not be started until the system check is completed properly. Perform a system check following the procedures on P.115. |

■ If “Charging Stopped Time Limit Reached” is shown

| Likely cause | Correction procedure |
|--|--|
| The DC charging is not completed within the restricted time with DC charger. | <ul style="list-style-type: none"> Depending on the type of DC charger, the timer may be set to stop charging after a certain time. Check with the charging station manager. <p>Depending on the condition of the vehicle, the charging time may become longer than normal, and the DC charging may not be completed within the restricted time.</p> <ul style="list-style-type: none"> When the A/C, headlights, audio system, etc., are turned on, the electricity consumption of the vehicle will be increased. Perform the DC charging after turning off all of the above. The temperature of the traction battery may be low. Perform the DC charging after warming up the traction battery. |

■ If “Charging Stopped Check Charging Source or Vehicle” is shown

| Likely cause | Correction procedure |
|---|---|
| Malfunction occurred in connector locking system. | Have the vehicle inspected by your Toyota dealer. |

Vehicle status information and indicators

3

147

3-1. Instrument cluster

Warning lights and indicators 148

Gauges and meters 152

Multi-information display 155

3

Vehicle status information and indicators

Warning lights and indicators

The warning lights and indicators on the instrument cluster and outside rear view mirrors inform the driver of the status of the vehicle's various systems.

Warning lights and indicators displayed on the instrument cluster

For the purpose of explanation, the following illustrations display all warning lights and indicators illuminated.

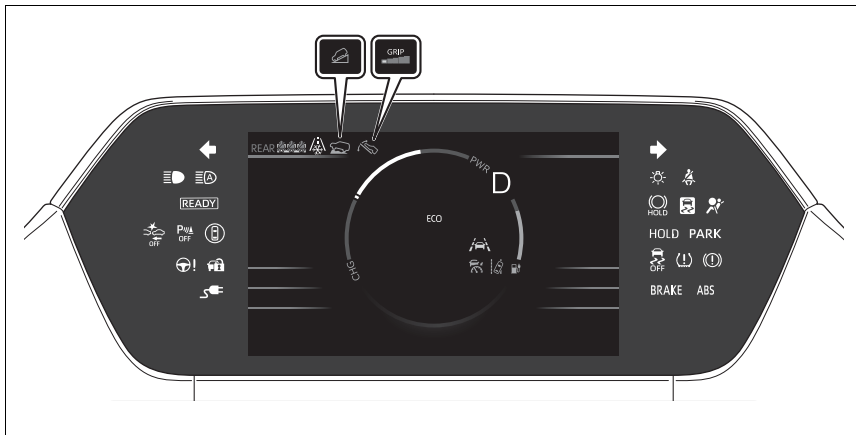



The units used on the meters and some indicators may differ depending on the target region.

Warning lights

Warning lights inform the driver of malfunctions in the indicated vehicle's systems.

 Brake system warning light*¹ (→P.513)

 Brake system warning light*¹ (→P.513)
(Red)















 Brake system warning light*¹ (→P.513)
(Yellow)



 Charging system warning light*² (→P.513)

 SRS warning light*¹ (→P.514)

 ABS warning light*¹ (→P.514)
(U.S.A.)

 ABS warning light*¹ (→P.514)
(Canada)

-  Inappropriate pedal operation warning light*²
(→P.514)
-  Electric power steering system warning light*¹
(Red) (→P.515)
-  Electric power steering system warning light*¹
(Yellow) (→P.515)
-  Traction battery charge warning light (→P.515)
-  Driver's and front passenger's seat belt reminder light (→P.515)
-  Rear passengers' seat belt reminder lights (→P.516)
-  Tire pressure warning light*¹ (→P.516)
-  LDA indicator (→P.516)
(Orange)
-  LTA indicator (→P.516)
(Orange)
-  Driving assist information indicator*¹ (→P.517)
-  Intuitive parking assist OFF indicator*¹ (if equipped) (→P.517)
(Flashes)
-  Cruise control indicator (→P.517)
(Orange)
-  Dynamic radar cruise control indicator (→P.518)
(Orange)
-  PCS warning light*¹
(Flashes or illuminates) (→P.518)
-  Slip indicator*¹ (→P.518)

-  PARK Parking brake indicator
(U.S.A.) (→P.518)
(Flashes)
-  PARK Parking brake indicator
(Canada) (→P.518)
(Flashes)
-  HOLD Brake hold operated indicator*¹ (→P.519)
(Flashes)

*¹: These lights come on when the power switch is turned to ON to indicate that a system check is being performed. They will turn off after the EV system is started, or after a few seconds. There may be a malfunction in a system if the lights do not come on, or turn off. Have the vehicle inspected by your Toyota dealer.

*²: This light illuminates on the multi-information display with a message.





























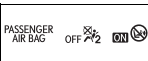

WARNING

■ If a safety system warning light does not come on

Should a safety system light such as the ABS and SRS warning light not come on when you start the EV system, this could mean that these systems are not available to help protect you in an accident, which could result in death or serious injury. Have the vehicle inspected by your Toyota dealer immediately if this occurs.

Indicators

The indicators inform the driver of the operating state of the vehicle's various systems.

| | | | |
|---|--|---|---|
|  | Turn signal indicator (→P.242) |  | VSC OFF indicator* ^{1, 2} (→P.388) |
|  | Headlight indicator (→P.248) |  | Charging cable indicator (→P.101) |
| (U.S.A.)  | Tail light indicator (→P.248) |  | Smart key system indicator* ³ (→P.231) |
| (Canada)  | Headlight high beam indicator (→P.250) |  | “READY” indicator (→P.231) |
|  | AHB indicator (→P.250) |  | Parking brake indicator (→P.243) |
|  | PCS warning light* ^{1, 2} (→P.265) | (U.S.A.)  | Parking brake indicator (→P.243) |
|  | Cruise control indicator (→P.296) | (Canada)  | Parking brake indicator (→P.243) |
| (*4)  | Dynamic radar cruise control indicator (→P.288) |  | Brake hold standby indicator* ¹ (→P.246) |
|  | LDA indicator (→P.285) |  | Brake hold operated indicator* ¹ (→P.246) |
| (*4) BSM outside rear view mirror indicators* ^{1, 5} (if equipped) (→P.302, 307, 322) | |  | Low outside temperature indicator* ⁶ (→P.153) |
|  | LDA OFF* ² indicator (→P.285) |  | Security indicator (→P.68, 69) |
|  | LTA indicator(→P.285) |  | “AIR BAG ON/OFF” indicator* ^{1, 7} (→P.44) |
| (*4) Driving assist information indicator* ^{1, 2} (→P.302, 322, 328, 331) | |  | Eco mode indicator (→P.241) |
|  | Intuitive parking assist OFF indicator* ^{1, 2} (if equipped) (→P.311) |  | Snow Mode indicator (if equipped) (→P.382) |
|  | Slip indicator* ¹ (→P.388) |  | Downhill assist control system indicator (if equipped) (→P.382) |
| (Flashes) | |  | Grip Control indicator (if equipped) (→P.382) |
| | |  | Grip Control set speed indicator (if equipped) (→P.385) |
| | |  | Regeneration Boost indicator (→P.240) |



SNOW/DIRT mode indicator (if equipped)
(*8) (→P.383)



D.SNOW/MUD mode indicator (if equipped)
(*8) (→P.383)

- *1: These lights come on when the power switch is turned to ON to indicate that a system check is being performed. They will turn off after the EV system is started, or after a few seconds. There may be a malfunction in a system if the lights do not come on, or turn off. Have the vehicle inspected by your Toyota dealer.
- *2: This light comes on when the system is turned off.
- *3: This light illuminates on the multi-information display with a message.
- *4: Depending on the operating condition, the color and illuminating/flashing state of the light change.
- *5: This light illuminates on the outside rear view mirrors.
- *6: When the outside temperature is approximately 37°F (3°C) or lower, the indicator will flash for approximately 10 seconds, then stay on.
- *7: This light illuminates on the overhead console.
- *8: Depending on the operating condition, the color of the light change.

Gauges and meters

The meters display various drive information.

Meter display

■ Locations of gauges and meters

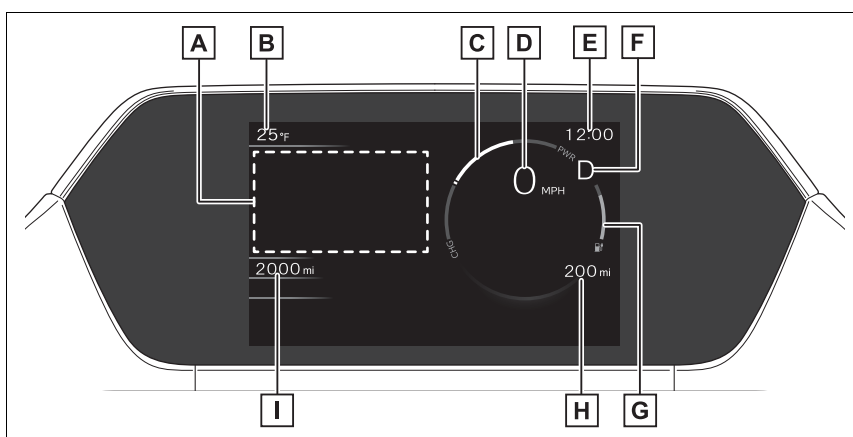

The units of measure may differ depending on the intended destination of the vehicle.

A Multi-information display

Presents the driver with a variety of vehicle data (→P.155)

Displays warning messages if a malfunction occurs (→P.522)

Display/hide for the multi-information display can be changed. (→P.154)

B Outside temperature

Displays the outside temperature within the range of -40°F (-40°C) to 140°F (60°C)

C Power meter (→P.153)

Displays EV system output or regeneration level

D Speedometer

Displays the vehicle speed

E Clock (→P.154)

F Shift position indicator (→P.236)

G SOC (State of Charge) gauge

Displays the amount of charge remaining in the traction battery.

H Driving range

Displays driving range with remaining charge. (→P.236)

When the air conditioning system is operating,  and the driving range with the air conditioning system on are displayed.

I Odometer and trip meter display (→P.154)

■ Power meter

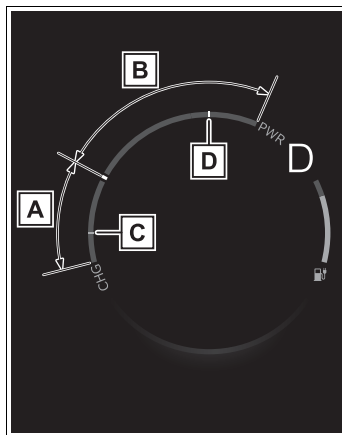

A Charge area

Shows regeneration^{*1} status.
Regenerated energy will be used to charge the EV battery (traction battery).

B Power area

Displays the EV system output (acceleration force) while driving.

C Regeneration^{*1} restrictions reference display^{*2}

In the following situations, regenerative braking is restricted, and the references for those restrictions are displayed in the charge area.

- When the traction battery has a large amount of charge and can no longer be regenerated

- When the temperature of the traction battery is extremely high or extremely low

D Output restrictions reference display^{*2}

In the following situations, the output is restricted, and the references for those restrictions are displayed in the power area.

- When the traction battery has a low amount of charge and can no longer output power
- When the temperature of the traction battery is extremely high or extremely low

^{*1}: The meaning of “Regeneration” here means converting kinetic energy into electrical energy.

^{*2}: The actual restrictions may differ depending on the vehicle condition.

■ Outside temperature display

- In the following situations, the correct outside temperature may not be displayed, or the display may take longer than normal to change:
 - When stopped, or driving at low speeds (less than 16 mph [25 km/h])
 - When the outside temperature has changed suddenly (at the entrance/exit of a garage, tunnel, etc.)
- When “--” is displayed, the system may be malfunctioning. Take your

vehicle to your Toyota dealer.

- When the outside temperature is approximately 37°F (3°C) or lower, the indicator  will flash for approximately 10 seconds, then stay on.

■ **Liquid crystal display**

→P.156

■ **Customization**

The gauges and meters can be customized in  of the multi-information display. (→P.566)

 **WARNING**

■ **The information display at low temperatures**

Allow the interior of the vehicle to warm up before using the liquid crystal information display. At extremely low temperatures, the information display monitor may respond slowly, and display changes may be delayed.

Switching the meter display

The multi-information display can be switched between display and hidden.

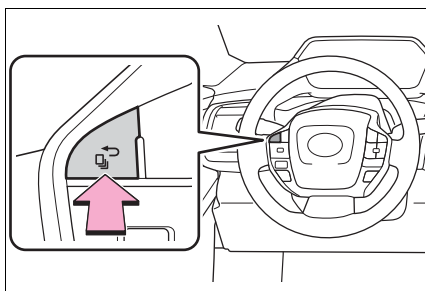

Odometer and trip meter display

■ **Display items**

- Odometer

Displays the total distance the vehicle has been driven.

- Trip meter A/Trip meter B

Displays the distance the vehicle has been driven since the meter was last reset. Trip meters A and B can be used to record and display different distances independently.

■ **Switching the display**

The display switches each time the switch is pressed. Also, when the switch is continuously pressed during the trip meter display, the driving distance can be changed to “0”.

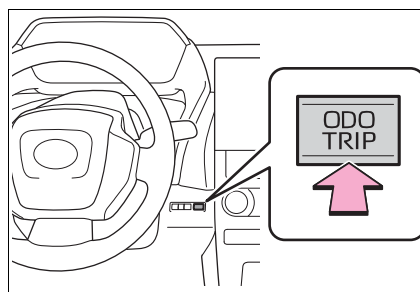



Adjusting the clock

The clocks on the following can be adjusted on the audio system screen.

- Multi-information display
- Audio system screen

For details, refer to “MULTIMEDIA OWNER’S MANUAL”.

If  is displayed when  is selected on the multi-information display, the system may be malfunctioning.
Have the vehicle inspected by your Toyota dealer.

Adjusting the instrument panel light control

The brightness of the instrument panel lights can be adjusted.

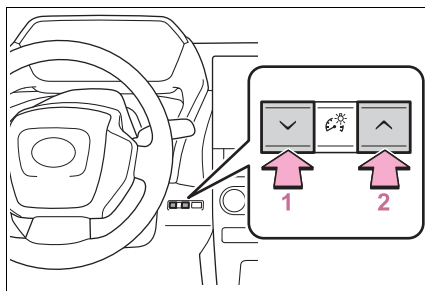

- 1 Darker
- 2 Brighter

Instrument panel illumination adjustment

The brightness level can be adjusted when the surroundings are bright (daytime, etc.) or dark (night-time, etc.).

Multi-information display

Display and menu icons

Display

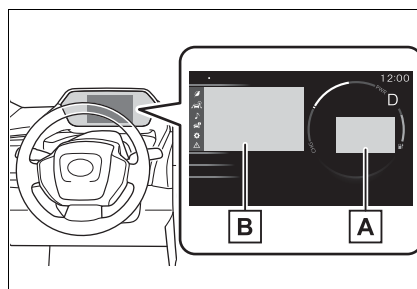

A Driving support system status display area

Displays an image when the following systems are operating and a menu icon other than  is selected:



- LDA (Lane Departure Alert) (→P.281)
- LTA (Lane Tracing Assist) (→P.276)
- Dynamic radar cruise control (→P.288)
- RSA (Road Sign Assist) (→P.286)







B Content display area

By selecting menu icons on the multi-information display, a variety of driving-related information can be displayed. The multi-information display can also be used to change display settings and other vehicle settings.

Warning or advice pop-up displays are also displayed in certain situations.

■ **Menu icons**

The menu icons will be displayed by pressing the  or  meter control switch.

-  Driving information display (→P.157)
-  Driving support system information display (→P.157)
-  Audio system-linked display (→P.157)
-  Vehicle information display (→P.158)
-  Settings display (→P.158)
-  Warning message display (→P.522)

■ **Liquid crystal display**

Small spots or light spots may appear on the display. This phenomenon is characteristic of liquid crystal displays, and there is no problem continuing to use the display.

 **WARNING**

■ **Caution for use while driving**



- When operating the multi-information display while driving, pay extra attention to the safety of the area around the vehicle.
- Do not look continuously at the multi-information display while driving as you may fail to see pedestrians, objects on the road, etc., ahead of the vehicle.

■ **The information display at low temperatures**
→P.153

Changing the meter display

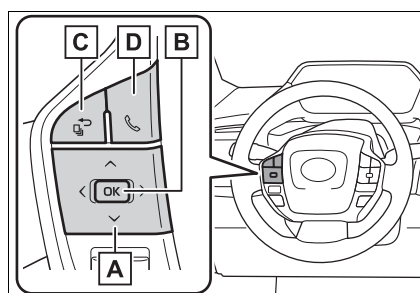
The multi-information display is operated using the meter control switches.



- A** : Select menu icons, scroll the screen and move the cursor
: Change displayed content, scroll the screen and move the cursor
- B** Press: Enter/Set
Press and hold: Reset/Display customizable items
- C** Return to the previous screen
- D** Call sending/receiving and history display

Linked with the hands-free system, sending or receiving call is displayed. For details regarding the hands-free system, refer to the "MULTIMEDIA OWNER'S MANUAL".

Content of driving information

■ **Power consumption**

Use the displayed values as a reference only.

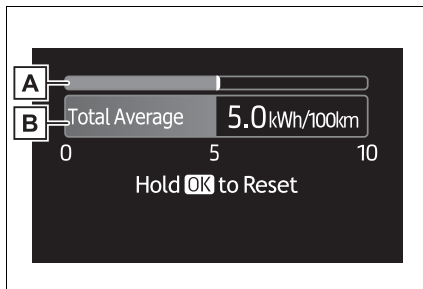

A Current power consumption

Displays instantaneous current power consumption.

B Trip Average/Total Average

To reset the average power consumption display, press and hold the OK meter control switch.

The average power consumption display can be changed in . (→P.566)

● Trip Average

Displays the average Power consumption since EV system start.

● Total Average

Displays the average power consumption since the vehicle was recharged.

■ **Power consumption**

It is a numerical value that represents the power consumption rate and corresponds to the fuel consumption rate of gasoline engine

vehicles. In this car, the number of miles traveled (miles / kWh) per kilowatt hour of electricity (1 kWh) is displayed on each screen as “electricity cost”.

Driving support system information display

■ **Driving support system information**

Select to display the operational status of the following systems:

- PCS (Pre-Collision System) (→P.265)
- LDA (Lane Departure Alert) (→P.281)
- LTA (Lane Tracing Assist) (→P.276)
- Cruise control (→P.296)
- Dynamic radar cruise control (→P.288)
- RSA (Road Sign Assist) (→P.286)

■ **Navigation system-linked display (if equipped)**

Select to display the following navigation system-linked information:

- Route guidance to destination
- Compass display (heading-up display)

Audio system-linked display

Select to enable selection of an audio source or track on the

meter using the meter control switches.

This menu icon can be set to be displayed/not displayed in .

Vehicle information display

■ Display items

- Drive information
- Torque distribution (if equipped)
- Tire inflation pressure

■ Drive information

2 items that are selected using the “Drive Info. Items” setting (average speed, distance and total time) can be displayed vertically.

The displayed information changes according to the “Drive Info. Type” setting (since the system was started or between resets). (→P.158)

Use the displayed information as a reference only.

Following items will be displayed.

- “Trip”
- “Average Speed”: Displays the average vehicle speed since EV system start*
- “Distance”: Displays the distance driven since EV system start*
- “Total Time”: Displays the elapsed time since EV system start*

*: These items are reset each time the EV system stops.

- “Total”
- “Average Speed”: Displays the average vehicle speed since the display was reset*
- “Distance”: Displays the distance driven since the display was reset*
- “Total Time”: Displays the elapsed time since the display was reset*

*: To reset, display the desired item and press and hold the OK meter control switch.

■ Torque distribution (if equipped)

Displays the drive status of each wheel in 6 steps from 0 to 5.

■ Tire inflation pressure

Displays inflation pressure of each tire.

Settings display

■ Meter display settings that can be changed

- Clock setting

→P.154

- Language

Select to change the language displayed.

- Units

Select to change the units of measure displayed.



- Power consumption display
Select to change the average power consumption display Trip Average/Total Average. (→P.157)



- Select to display/not display the audio system linked display.



- Select to change the displayed content of the following:

- Display contents (AWD models only)

- Select to display/not display the torque distribution display.

- Drive information type

- Select to change the drive information type display between after start/after reset.

- Drive information items

- Select to set the first and second items of the drive information display to any of the following: average vehicle speed/distance/elapsed time.

- Closing Display

- Select to set the items displayed when the power switch is turned off.

- Pop-up display

- Select to enable/disable pop-up displays for each relevant system.

- Calendar

- The year, month, and day can be set.

- Default setting

- Select to reset the meter display

settings to the default setting.

■ Vehicle functions and settings that can be changed

→P.566

■ Suspension of the settings display

- Some settings cannot be changed while driving. When changing settings, park the vehicle in a safe place.
- If a warning message is displayed, operation of the settings display will be suspended.

 NOTICE

■ During setting up the display

To prevent 12-volt battery discharge, ensure that the EV system is operating while setting up the display features.

Suggestion function

Displays suggestions to the driver in the following situations. To select a response to a displayed suggestion, use the meter control switches.

■ Suggestion to turn on the headlights

If the headlight switch is in other than  or AUTO, and the vehicle speed is 3 mph (5 km/h) or higher for a certain amount of time when the surroundings are dark, a suggestion message will be displayed.

■ **Suggestion to turn off the headlights**

If the headlights are left on for a certain amount of time after the power switch has been turned off, a suggestion message will be displayed.

When the headlight switch is in the AUTO position: The message asking if you wish to turn the headlights off is displayed. To turn the headlights off, select "Yes".

If the driver's door is opened after the power switch is turned off, this suggestion message will not be displayed.

■ **Customization**

The suggestion function can be turned on/off. (Customizable features: →P.566)

Before driving**4****4-1. Key information**

Keys 162

Digital key 165

4-2. Opening, closing and locking the doors

Side doors 167

Back door 172

Smart key system 187

4-3. Adjusting the seats

Front seats 192

Rear seats 193

Head restraints 196

4-4. Adjusting the steering wheel and mirrors

Steering wheel 199

Inside rear view mirror 200

Digital Rear-view Mirror 201

Outside rear view mirrors
..... 210**4-5. Opening, closing the windows**

Power windows 212

4-6. Favorite settings

My Settings 215

Keys

Key types

The following keys are provided with the vehicle.

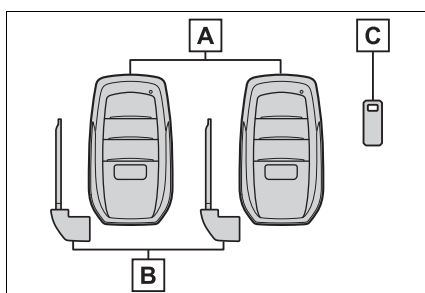

A Electronic keys

- Operating the smart key system (→P.187)
- Operating the wireless remote control function (→P.164)
- Operating the Remote Air Conditioning System (→P.409)

B Mechanical keys

C Key number plate

■ When riding in an aircraft

When bringing an electronic key onto an aircraft, make sure you do not press any buttons on the electronic key while inside the aircraft cabin. If you are carrying an electronic key in your bag, etc., ensure that the buttons are not likely to be pressed accidentally. Pressing a button may cause the electronic key to emit radio waves that could interfere with the operation of the aircraft.

■ Electronic key battery depletion

- The standard battery life is 1 to 2 years.
- If the battery becomes low, an alarm will sound in the cabin and a

message will be displayed on the multi-information display when the EV system stops.

- To reduce key battery depletion when the electronic key is to not be used for long periods of time, set the electronic key to the battery-saving mode. (→P.188)
- As the electronic key always receives radio waves, the battery will become depleted even if the electronic key is not used. The following symptoms indicate that the electronic key battery may be depleted. Replace the battery when necessary.
 - The smart key system or the wireless remote control does not operate.
 - The detection area becomes smaller.
 - The LED indicator on the key surface does not turn on.

You can replace the battery by yourself (→P.497). However, as there is a danger that the electronic key may be damaged, it is recommended that replacement is carried out by your Toyota dealer.

- To avoid serious deterioration, do not leave the electronic key within 3 ft. (1 m) of the following electrical appliances that produce a magnetic field:

- TVs
- Personal computers
- Cellular phones, cordless phones and battery chargers
- Table lamps
- Induction cookers

- If the electronic key is near the vehicle for longer than necessary, even if the smart key system is not operated, the key battery may become depleted faster than normal.

■ If a message regarding the state of the electronic key or power switch mode, etc. is shown

To prevent trapping the electronic

key inside the vehicle, leaving the vehicle carrying the electronic key on your person without turning the power switch to OFF or other passengers from unintentionally taking the key out of the vehicle, etc., a message that prompts the user to confirm the state of the electronic key or power switch mode may be shown on the multi-information display. In those cases, follow the instructions on the display immediately.

■ **If “Key Battery Low Replace Key Battery” is displayed on the multi-information display**

The electronic key has a low battery. Replace the electronic key battery. (→P.497)

■ **Replacing the battery**

→P.497

■ **Confirmation of the registered key number**

The number of keys already registered to the vehicle can be confirmed. Ask your Toyota dealer for details.

■ **If “A New Key has been Registered Contact Your Dealer for Details” is displayed on the multi-information display**

This message will be displayed each time the driver's door is opened when the doors are unlocked from the outside for approximately 10 days after a new electronic key has been registered. If this message is displayed but you have not had a new electronic key registered, ask your Toyota dealer to check if an unknown electronic key (other than those in your possession) has been registered.

 NOTICE

■ **To prevent key damage**

- Do not drop the keys, subject them to strong shocks, or bend them.
- Do not expose the keys to high temperatures for long periods of time.
- Do not get the keys wet or wash them in an ultrasonic washer, etc.
- Do not attach metallic or magnetic materials to the keys or place the keys close to such materials.
- Do not disassemble the keys.
- Do not attach a sticker or anything else to the surface of the electronic key.
- Do not place the keys near objects that produce magnetic fields, such as TVs, audio systems and induction cookers.
- Do not place the keys near medical electrical equipment such as low-frequency therapy equipment or microwave therapy equipment, and do not receive medical attention with the keys on your person.

■ **Carrying the electronic key on your person**

Carry the electronic key 3.9 in. (10 cm) or more away from electric appliances that are turned on. Radio waves emitted from electric appliances within 3.9 in. (10 cm) of the electronic key may interfere with the key, causing the key to not function properly.

 NOTICE

■ In case of a smart key system malfunction or other key-related problems

→P.539

■ When an electronic key is lost

→P.539

Wireless remote control

The electronic keys are equipped with the following wireless remote control:

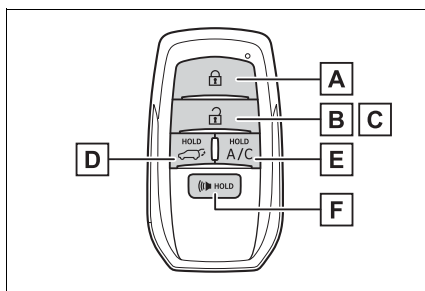

A Locks all the doors (→P.167)

B Unlocks all the doors (→P.167)

C Opens the side windows*¹ (→P.167)

D Opens and closes the power back door*² (→P.175)

E Operates Remote Air Conditioning System (→P.409)

F Sounds the alarm (→P.164)

*¹: These settings must be customized at your Toyota dealer.

*²: If equipped

■ Theft deterrent panic mode

When  is pressed for longer than about 1 second, an alarm will sound intermittently and the vehicle lights will flash to deter any person from trying to break into or damage your vehicle.

To stop the alarm, press any button on the electronic key.

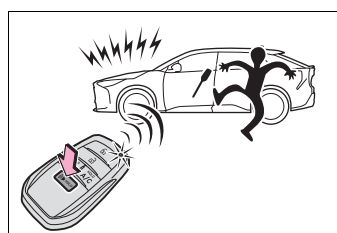

■ Conditions affecting operation

→P.188

Using the mechanical key

To take out the mechanical key, slide the release lever **A** and take the key out.

The mechanical key can only be inserted in one direction, as the key only has grooves on one side. If the key cannot be inserted in a lock cylinder, turn it over and re-attempt to insert it.

After using the mechanical key, store it in the electronic key. Carry the mechanical key together with the electronic key. If the electronic key battery is depleted or the entry function does not operate properly, you will need the mechanical key. (→P.539)

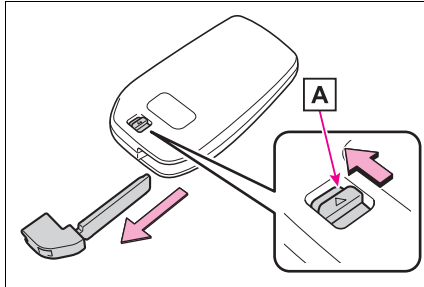

■ **When required to leave the vehicle's key with a parking attendant**

Remove the mechanical key for your own use and provide the attendant with the electronic key only.

■ **If you lose your mechanical keys**

→P.539

■ **If a wrong key is used**

The key cylinder rotates freely to isolate inside mechanism.

Digital key*

*: If equipped

A smartphone can be used instead of the electronic key of the vehicle by installing the dedicated Digital Key App on a smartphone. Also, Digital Key can be shared with your family or friends using the Digital Key App.

■ **Free/open source software information**

This product contains Free/open source software (FOSS).

License information and/or the source code of this FOSS can be obtained at the following URL:

<https://www.denso.com/global/en/opensource/dkey/toyota/>

Digital key usage conditions

In order to use the Digital Key, you need to install the Toyota App, Register the Vehicle to the customer's Toyota App profile, and subscribe to Remote Services, and enroll in Digital Key

Digital key precautions

- A Digital Key can be used when the smartphone and server can communicate. The Digital Key may become unusable if the smartphone is not connected to the Internet. Be sure to carry the electronic

4
Before driving

key of the vehicle if traveling to a location with unreliable communications.

- If the smartphone battery is depleted, the smartphone cannot be used as Digital Key. If the battery level is low, be sure to charge the smartphone prior to going out.
- The Digital Key system is related to the Smart key system. If the Smart key system has been deactivated in the vehicle customization setting, the Digital Key will also be disabled.
- Depending on the radio wave environment, the Digital Key may not be able to be used.
→P.188
- When transferring vehicle ownership, make sure to delete the Digital Keys.
- If the vehicle is not operated for 14 days or more, the Digital Key will not connect automatically. Therefore, it may take some time before the system operates after a door handle is touched.
- A part of the services may be stopped for a certain period of time due to server maintenance. However, registered Digital Keys can be used during the maintenance.
- A smartphone with the Digital Key App enabled will be able to lock and unlock the doors, start the EV system and perform any other operations as same as the electronic key of the vehicle. Be especially careful not to lose the smartphone or allow it to be stolen. If the smartphone is lost or stolen, contact your Toyota dealer immediately.
- When taking your vehicle to a Toyota dealer for an inspection or repairs, make sure to bring an electronic key.

Side doors

The vehicle can be locked and unlocked using the entry function, wireless remote control, door lock switches or inside lock buttons.

Unlocking and locking the doors from the outside

■ Using the entry function

Carry the electronic key to enable this function.

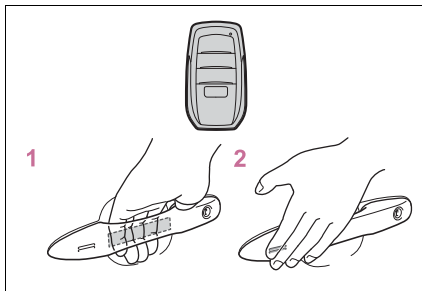

- 1 Grip the driver's door handle to unlock the door. Holding the driver's door handle for approximately 2 seconds unlocks all the doors. Grip the front passenger's door handle (some models) or rear door handle (some models) to unlock all the doors*.

Make sure to touch the sensor on the back of the handle. The doors cannot be unlocked for 3 seconds after the doors are locked.

*: The door unlock settings can be

changed. (→P.167)

- 2 Touch the lock sensor (the indentation on the side of the door handle) to lock the doors.

Check that the door is securely locked.

■ Using the wireless remote control

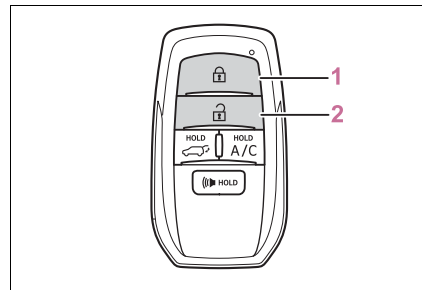

- 1 Locks all the doors

Check that the door is securely locked.

- 2 Unlocks all the doors

Pressing the button unlocks the driver's door. Pressing the button again within 5 seconds unlocks the other doors.

Press and hold to open the side windows.*





*: This setting must be customized at your Toyota dealer.

■ Switching the door unlock function



It is possible to set which doors the entry function unlocks using the wireless remote control. Perform the switching operation in the vehicle or within approximately 3.2 ft. (1 m) of the vehicle.

- 1 Turn the power switch to OFF.

4 Before driving

- When the indicator light on the key surface is not on, press and hold ,  or  for approximately 5 seconds while pressing and holding .

The setting changes each time an operation is performed, as shown below. (When changing the setting continuously, release the buttons, wait for at least 5 seconds, and repeat step 2.)

| Multi-information display/Beep | Unlocking function |
|--|--|
|  Exterior: Beeps 3 times | Holding the driver's door handle unlocks only the driver's door. Holding the passenger's door handle or pressing the back door opener switch unlocks all the doors. |
|  Exterior: Beeps twice | Holding a door handle or pressing the back door opener switch unlocks all the doors. |

Vehicles with alarm: To prevent unintended triggering of the alarm, unlock the doors using the wireless remote control and open and close a door once after the settings have been changed. (If a door is not opened within 60 seconds after  is pressed, the doors will be locked again and the alarm will automatically be set.)

In a case that the alarm is triggered, immediately stop the alarm. (→P.69)

■ **Locking the front doors from the outside without a key**

- Move the inside lock button to the lock position. (→P.170)
- Close the door.

The door cannot be locked if the power switch is in ACC or ON, or the electronic key is left inside the vehicle.

Depending on the position of the electronic key, the key may not be detected correctly and the door may be locked.

■ **Impact detection door lock release system**

In the event that the vehicle is subject to a strong impact, all the doors are unlocked. Depending on the force of the impact or the type of accident, however, the system may not operate.

■ **Operation signals**

Doors: A buzzer sounds and the emergency flashers flash to indicate that the doors have been locked/unlocked. (Locked: Once; Unlocked: Twice)

Side windows: A buzzer sounds to indicate that the side windows are operating.

■ **Security feature**

If a door is not opened within approximately 60 seconds after the vehicle is unlocked, the security feature automatically locks the vehicle again. (However, depending on the location of the electronic key, the key may be detected as being in the vehicle. In this case, vehicle may be unlocked.)

■ **When the door cannot be locked by the lock sensor on the surface of the door handle**

When the door cannot be locked even if the lock sensor on the surface of the door handle is touched

by a finger, touch the lock sensor with the palm.

When gloves are being worn, remove the gloves.

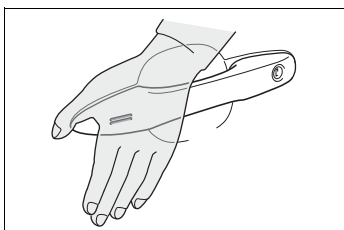

■ **Door lock buzzer**

If an attempt to lock the doors using the smart key system is made when a door other than the door you are locking is open, a buzzer sounds continuously for 5 seconds. Fully close all the doors, and lock the vehicle once more.

■ **Setting the alarm (if equipped)**

Locking the doors will set the alarm system. (→P.69)

■ **Conditions affecting the operation of the smart key system or wireless remote control**

→P.188

■ **If the smart key system or the wireless remote control does not operate properly**

- Use the mechanical key to lock and unlock the doors. (→P.539)
- Replace the key battery with a new one if it is depleted. (→P.497)

■ **If the 12-volt battery is discharged**

The doors cannot be locked and unlocked using the smart key system or wireless remote control. Lock or unlock the doors using the mechanical key. (→P.539)

■ **Rear seat reminder function**

- In order to remind you not to forget luggage, etc., in the rear seat, when the power switch is turned to OFF after any of the following conditions are met, a buzzer will

sound and a message will be displayed on the multi-information display for approximately 6 seconds.

- The EV system is started within 10 minutes after opening and closing a rear door.
- A rear door has been opened and closed after the EV system was started.

However, if a rear door is opened and then closed within approximately 2 seconds, the rear seat reminder function may not operate.

- The rear seat reminder function determines that luggage, etc., has been placed in a rear seat based on opening and closing of a rear door. Therefore, depending on the situation, the rear seat reminder function may not operate and you may still forget luggage, etc., in the rear seat, or it may operate unnecessarily.
- The rear seat reminder function can be enabled/disabled. (→P.566)

■ **Customization**

Settings (e.g. unlocking function using a key) can be changed. (Customizable features: →P.569)

⚠ WARNING

■ **To prevent an accident**

Observe the following precautions while driving the vehicle. Failure to do so may result in a door opening and an occupant could be thrown out of the vehicle, resulting in death or serious injury.

- Ensure that all doors are properly closed and locked.

⚠ WARNING

- Do not pull the inside handle of the doors while driving. Be especially careful for the front doors, as the doors may be opened even if the inside lock buttons are in locked position.

- Set the rear door child-protector locks when children are seated in the rear seats.

■ **When opening or closing a door**

Check the surroundings of the vehicle such as whether the vehicle is on an incline, whether there is enough space for a door to open and whether a strong wind is blowing. When opening or closing the door, hold the door handle tightly to prepare for any unpredictable movement.

■ **When using the wireless remote control or mechanical key and operating the power windows**

Operate the power window after checking to make sure that there is no possibility of any passenger having any of their body parts caught in the side window. Also, do not allow children to operate the wireless remote control or mechanical key. It is possible for children and other passengers to get caught in the side window.

Unlocking and locking the doors from the inside

■ **Using the door lock switches**

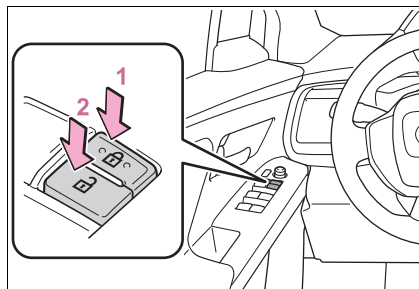

- 1 Locks all the doors
- 2 Unlocks all the doors

■ **Using the inside lock buttons**

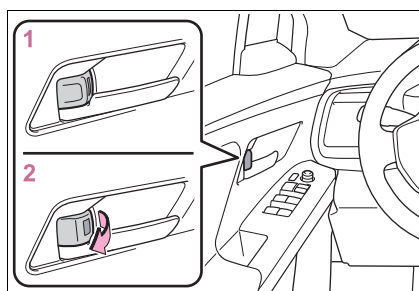

- 1 Locks the door
- 2 Unlocks the door

The front doors can be opened by pulling the inside handle even if the lock buttons are in the lock position.

■ **Open door warning buzzer**

If the vehicle speed reaches 3 mph (5 km/h), a buzzer sounds to indicate that the door(s) or the hood is not fully closed.

The open door(s) or hood is displayed on the multi-information display.

When all the doors are locked with the entry function or wireless remote control

- The doors cannot be unlocked with the door lock switch.
- The door lock switches can be reset by unlocking all the doors with the entry function or wireless remote control.

Rear door child-protector lock

The door cannot be opened from inside the vehicle when the lock is set.

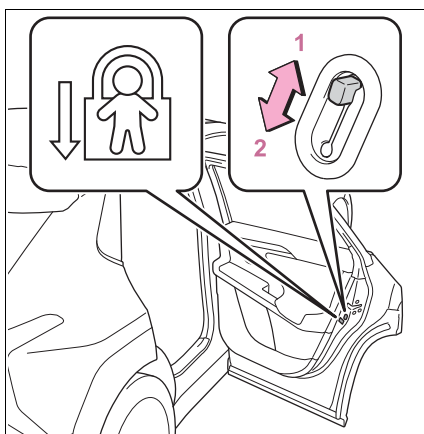

- 1 Unlock
- 2 Lock

These locks can be set to prevent children from opening the rear doors. Push down on each rear door switch to lock both rear doors.

Automatic door locking and unlocking systems

The following functions can be set or canceled:

For instructions on customizing,

refer to P.566.

| Function | Operation |
|---|---|
| Speed linked door locking function | All doors are automatically locked when vehicle speed is approximately 12mph (20 km/h) or higher. |
| Shift position linked door locking function | All doors are automatically locked when shifting the shift position other than P. |
| Shift position linked door unlocking function | All doors are automatically unlocked when shifting the shift position to P. |
| Driver's door linked door unlocking function | All doors are automatically unlocked when driver's door is opened within approximately 45 seconds after turning the power switch off. |

4
Before driving

Back door

The back door can be locked/unlocked and opened/closed by the following procedures.

WARNING

Observe the following precautions. Failure to do so may result in death or serious injury.

■ Before driving

- Make sure that the back door is fully closed. If the back door is not fully closed, it may open unexpectedly while driving and hit nearby objects or luggage in the luggage compartment may be thrown out, causing an accident.
- Do not allow children to play in the luggage compartment. If a child is accidentally locked in the luggage compartment, they could get heat exhaustion or other injuries.
- Do not allow a child to open or close the back door. Doing so may cause the back door to operate unexpectedly, or cause the child's hands, head, or neck to be caught by the closing back door.

■ Important points while driving

- Keep the back door closed while driving. If the back door is left open, it may hit near-by objects or luggage in the luggage compartment may be thrown out, causing an accident.

- Never let anyone sit in the luggage compartment. In the event of sudden braking, sudden swerving or a collision, they are susceptible to death or serious injury.

■ Back door handles

Do not hang any object to the back door handles. If any object is hung, the back door may suddenly shut, causing parts of the body to be caught, resulting in death or serious injury.

■ Operating the back door

- Observe the following precautions. Failure to do so may cause parts of the body to be caught, resulting in death or serious injury.
- Remove any heavy loads, such as snow and ice, from the back door before opening it. Failure to do so may cause the back door to suddenly shut again after it is opened.
 - When opening or closing the back door, thoroughly check to make sure the surrounding area is safe.
 - If anyone is in the vicinity, make sure they are safe and let them know that the back door is about to open or close.
 - Use caution when opening or closing the back door in windy weather as it may move abruptly in strong wind.

⚠ WARNING

- Vehicles without power back door: The back door may suddenly shut if it is not opened fully. It is more difficult to open or close the back door on an incline than on a level surface, so beware of the back door unexpectedly opening or closing by itself. Make sure that the back door is fully open and secure before using the luggage compartment.

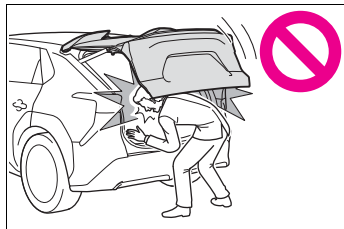

- Vehicles with power back door: The back door may suddenly shut if it is not opened fully, while on a steep incline. Make sure that the back door is secured before using the luggage compartment.
- When closing the back door, take extra care to prevent your fingers, etc., from being caught.

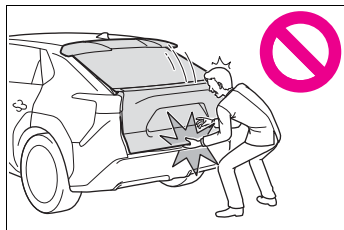

- Vehicles without power back door: When closing the back door, make sure to press it lightly on its outer surface. If the back door handle is used to fully close the back door, it may result in hands or arms being caught.

- Vehicles without power back door: Do not pull on the back door damper stay (→P.175) to close the back door, and do not hang on the back door damper stay. Doing so may cause hands to be caught or the back door damper stay to break, causing an accident.
- Vehicles with power back door: Do not pull on the back door spindle (→P.184) to close the back door, and do not hang on the back door spindle. Doing so may cause hands to be caught or the back door spindle to break, causing an accident.
- Vehicles without power back door: If a bicycle carrier or similar heavy object is attached to the back door, it may suddenly shut again after being opened, causing someone's hands, head or neck to be caught and injured. When installing an accessory part to the back door, using a genuine Toyota part is recommended.

Unlocking and locking the back door from the outside

- Using the entry function (if equipped)

Carry the electronic key to enable this function.

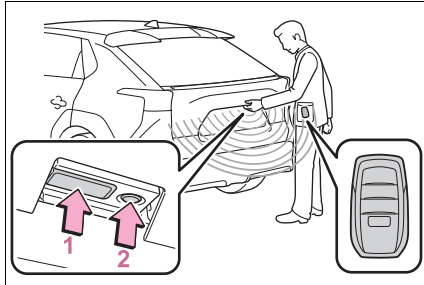

- 1 Unlocks all the doors
The doors cannot be unlocked for 3 seconds after the doors are locked.
- 2 Locks all the doors
Check that the door is securely locked.

■ **Using the wireless remote control**

→P.167

■ **Operation signals**

→P.168

■ **Security feature**

→P.168

Unlocking and locking the back door from the inside

■ **Using the door lock switches**

→P.170

Opening/closing the back door (vehicles without power back door)

■ **Open**

Raise the back door while pressing up the back door opener switch.

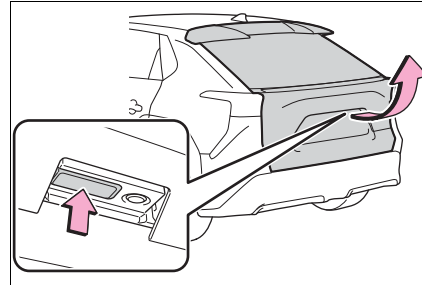

■ **Close**

Lower the back door using the back door handle, and make sure to push the back door down from the outside to close it.

Be careful not to pull the back door sideways when closing the back door with the handle.

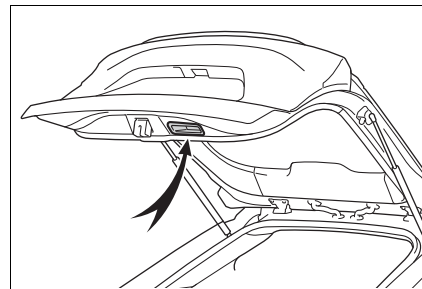

■ **Luggage compartment light**

- The luggage compartment light turns on when the back door is opened.
- When the power switch is turned to OFF, the light will go off automatically after 20 minutes.

■ **If the back door opener is inoperative**

The back door can be unlocked from the inside.

- 1 Remove the cover.

To prevent damage, cover the tip of the screwdriver with a rag.

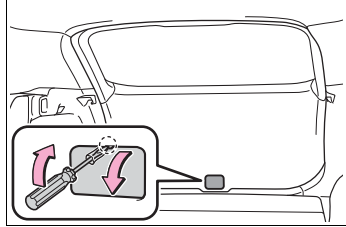

2 Loosen the screw and move the cover.

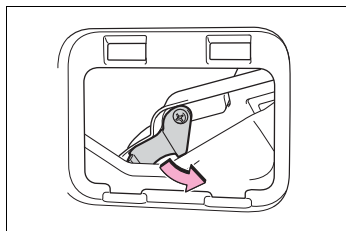

3 Move the lever.

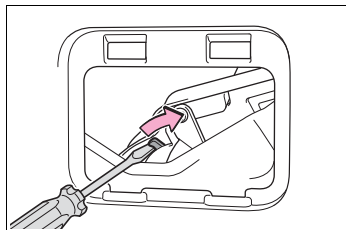

4 When installing, reverse the steps listed.

■ **Open door warning buzzer**
→P.170

 **NOTICE**

■ **Back door damper stays**

The back door is equipped with damper stays that hold the back door in place. Observe the following precautions. Failure to do so may cause damage to the back door damper stay, resulting in malfunction.

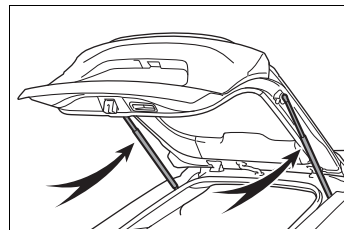

- Do not attach any foreign objects, such as stickers, plastic sheets, or adhesives to the damper stay rod.
- Do not touch the damper stay rod with gloves or other fabric items.
- Do not attach any accessories other than genuine Toyota parts to the back door.
- Do not place your hand on the damper stay or apply lateral forces to it.

Opening/closing the back door (vehicles with power back door)

■ **Using the wireless remote control**

Press and hold the switch.

The power back door automatically opens/closes.

Pressing the switch while the power back door is opening/closing stops

the operation. When the switch is pressed and held again during the halted operation, the back door will perform the reverse operation.

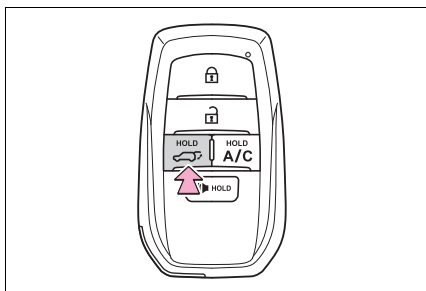

■ **Using the power back door switch on the instrument panel**

Press and hold the switch.

The power back door automatically opens/closes.

Unlock the back door before operating.

Pressing the switch while the power back door is opening/closing stops the operation. When the switch is pressed and held again during the halted operation, the back door will perform the reverse operation.

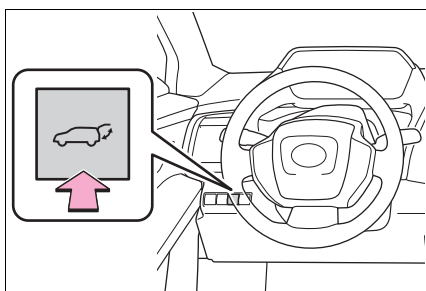

■ **Opening the back door using the back door opener switch**

When the back door is

unlocked: Press the back door opener switch.

When the back door is locked: While carrying the electronic key on your person, press and hold the back door opener switch.

The power back door automatically opens.

Pressing the switch while the power back door is opening stops the operation. Pressing the switch again will open the back door automatically.

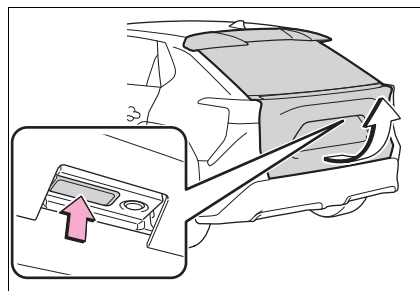

■ **Using the power back door switch on the back door**

● **Close**

Press the switch.

The power back door automatically closes.

Pressing the switch while the power back door is operating will stop the operation.

When the switch is pressed again during the halted operation, the back door will perform the reverse operation.

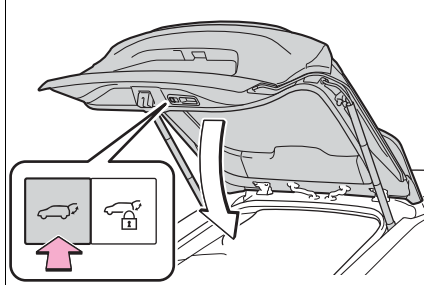

- Close the back door and lock all doors (close & lock function)

While carrying the electronic key on your person, press the switch.

After operating the switch, the power back door will not close for about 30 seconds when it is within the detection area of the electronic key. (→P.187)

After operating the switch, the power back door closes when it goes out of the detection area of the electronic key.

Also, if entering the detection area of the electronic key while power back door is closing, the power back door will stop.

A different buzzer than the normal one will sound and the power back door will begin closing automatically. When the power back door is closed, all of the doors will lock simultaneously and operation signals will indicate that all of the doors have been locked.

If the switch is pressed while the power back door is closing, the operation will stop.

When the switch is pressed again during the halted operation, the back door will perform the reverse operation.

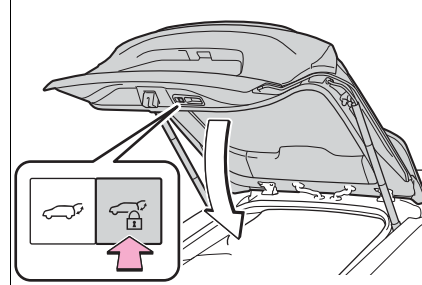

- Using the back door handles

Lower the back door using the back door handle.

The back door closing assist (→P.179) will be activated, and the power back door will fully close automatically.

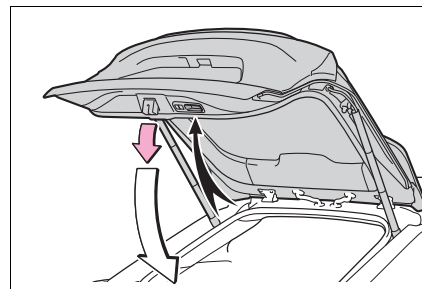

- Using the kick sensor (vehicles with Hands Free Power Back Door)

When operating the Hands Free Power Back Door, make sure that the power switch is in OFF, the Hands Free Power Back Door operation is enabled (→P.180) and you are carrying an electronic key.

- 1 While carrying an electronic key, stand within the smart key system operation range, approximately 11.8 to 19.7 in.

(30 to 50 cm) from the rear bumper.

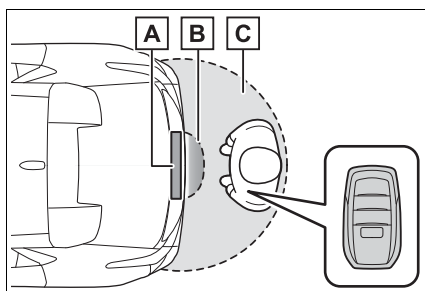

- A** Kick sensor
- B** Hands Free Power Back Door operation detection area
- C** Smart key system operation detection area (→P.187)

- 2 Perform a kick operation by moving your foot to within approximately 3.9 in. (10 cm) of the rear bumper and then pulling it back.

Perform the entire kick operation within 1 second.

The back door will not start operating while a foot is detected under the rear bumper.

Operate the Hands Free Power Back Door without contacting the rear bumper with your foot.

If another electronic key is in the cabin or luggage compartment, it may take slightly longer than nor-

mal for the operation to occur.

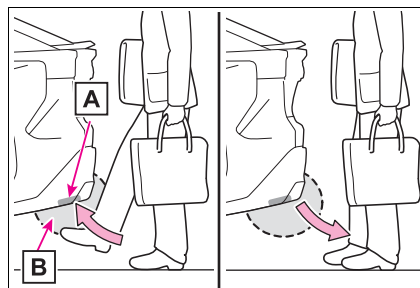

- A** Kick sensor
- B** Hands Free Power Back Door operation detection area

- 3 When the kick sensor detects a kicking motion with the foot, the buzzer sounds, and when the foot being pulled is detected, the back door automatically fully opens or fully closes.

The buzzer can be turned off with the customize function. (→P.570)

If a foot is moved under the rear bumper while the back door is opening/closing, the back door will stop moving.

If a foot is moved under the rear bumper again during the halted operation, the back door will perform the reverse operation.

■ Luggage compartment light

- The luggage compartment light turns on when the back door is opened.
- When the power switch is turned to OFF, the light will go off automatically after 20 minutes.

■ Back door closer

In the event that the back door is left slightly open, the back door closer will automatically close it to the fully

closed position.

Whatever the state of the power switch, the back door closer operates.

■ Power back door operating conditions

The power back door can automatically open and close under the following conditions:

- When the power back door system is enabled. (→P.185)
- When the power switch is in ON, in addition to the above for the opening operations, the back door operates for any of the following conditions:
 - Parking brake is engaged
 - The brake pedal is depressed
 - The shift position is in P.

■ Operation of the power back door

- A buzzer sounds and the emergency flashers flash twice to indicate that the back door is opening/closing.
- When the power back door system is disabled, the power back door does not operate but it can be opened and closed by hand.
- When the power back door automatically opens, if an abnormality due to people or objects is detected, operation will stop.

■ Jam protection function

Sensors are equipped on both sides of the power back door. If anything obstructs the power back door while it is closing, the back door will automatically operate in the opposite direction or stop.

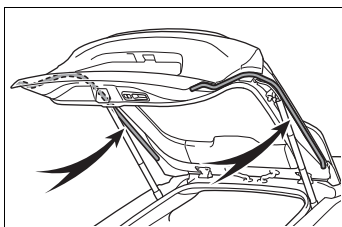

■ Fall-down protection function

While the power back door is opening automatically, applying excessive force to it will stop the opening operation to prevent the power back door from suddenly shutting.

■ Back door closing assist

If the back door is lowered manually when the back door is stopped at an open position, the back door will fully close automatically.

■ Back door reserve lock function

This function is a function which reserves locking of all doors, beforehand, when the power back door is open.

When the following procedure is performed, all the doors except the power back door are locked and then power back door will also be locked at the same time it is closed.

- 1 Close all doors, except the back door.
- 2 During the power back door closing operation, lock the doors using the smart key system from the side doors (→P.167) or the wireless remote control. (→P.167)

Operation signals will indicate that all the doors have been closed and locked (→P.168).

- If the electronic key is placed inside the vehicle after starting a close operation via the door reserve lock function, the electronic key may become locked inside the vehicle.
- If the power back door does not fully close due to the operation of the jam protection function, etc., while the back door is automatically closing after a door reserve lock operation is performed, the door reserve lock function is canceled and all the doors will unlock.
- Before leaving the vehicle, make sure that all the doors are closed and locked.

■ Close & lock function

When the power back door is open, this function closes the power back door and then locks all of the doors simultaneously.

When the following procedures are performed and there are no electronic keys for the vehicle within the vehicle, all of the doors will lock when the power back door is completely closed.



- 1 Close all of the doors except the power back door.
- 2 While carrying an electronic key, press the  switch on the lower part of the power back door (→P.176).

A different buzzer than the normal one will sound and then the power back door will begin closing automatically. When the power back door is closed, all of the doors will lock simultaneously and operation signals will indicate that all of the doors have been locked.

The double locking system will not operate at this time.

■ Situations in which the close & lock function may not operate properly

In the following situations, the close & lock function may not operate properly:

- If the  switch on the lower part of the power back door (→P.176) is pressed by a hand which is holding an electronic key
- If the  switch on the lower part of the power back door (→P.176) is pressed when the electronic key is in a bag, etc., that is placed on the ground
- If the  switch on the lower part of the power back door (→P.176) is pressed with the electronic key

not near the vehicle.

■ Hands Free Power Back Door operating conditions (vehicles with Hands Free Power Back Door)

The Hands Free Power Back Door will open/close automatically when the following conditions are met:

- The Hands Free Power Back Door operation is enabled (→P.185)
- The power switch is in OFF.
- The electronic key is within the operational range. (→P.187)
- A foot is put near the lower center part of the rear bumper and moved away from the rear bumper.

The power back door may also be operated by putting a hand, an elbow, a knee, etc. near the lower center part of the rear bumper and moving it away from the rear bumper. Make sure to put it close enough to the center part of the rear bumper.

■ Situations in which the Hands Free Power Back Door may not operate properly (vehicles with Hands Free Power Back Door)

In the following situations, the Hands Free Power Back Door may not operate properly:

- When a foot remains under the rear bumper
- If the rear bumper is strongly hit with a foot or is touched for a while

If the rear bumper has been touched for a while, wait for a short time before attempting to operate the Hands Free Power Back Door again.

- When operated while a person is too close to the rear bumper
- When an external radio wave source interferes with the communication between the electronic key and the vehicle (→P.188)

- When charging from an external power source or connecting the AC charging cable
 - When the vehicle is parked near an electrical noise source which affects the sensitivity of the Hands Free Power Back Door, such as a pay parking spot, gas station, electrically heated road, or fluorescent light
 - When the vehicle is near a TV tower, electric power plant, radio station, large display, airport or other facility that generates strong radio waves or electrical noise
 - When a large amount of water is applied to the rear bumper, such as when the vehicle is being washed or in heavy rain
 - When mud, snow, ice, etc. is attached to the rear bumper
 - When the vehicle has been parked for a while near objects that may move and contact the rear bumper, such as plants
 - When an accessory is installed to the rear bumper
- If an accessory has been installed, turn the Hands Free Power Back Door operation setting off.
- **Preventing unintentional operation of the Hands Free Power Back Door (vehicles with Hands Free Power Back Door)**
- When an electronic key is in the operation range, the Hands Free Power Back Door may operate unintentionally, so be careful in the following situations.
- When a large amount of water is applied to the rear bumper, such as when the vehicle is being washed or in heavy rain
 - When dirt is wiped off the rear bumper
 - When a small animal or small object, such as a ball, moves under the rear bumper
 - When an object is moved from under the rear bumper
 - If someone is swinging their legs while sitting on the rear bumper
 - If the legs or another part of someone's body contacts the rear bumper while passing by the vehicle
 - When the vehicle is parked near an electrical noise source which affects the sensitivity of the Hands Free Power Back Door, such as a pay parking spot, gas station, electrically heated road, or fluorescent light
 - When the vehicle is near a TV tower, electric power plant, radio station, large display, airport or other facility that generates strong radio waves or electrical noise
 - When the vehicle is parked in a place where objects such as plants are near the rear bumper
 - If luggage, etc. is set near the rear bumper
 - If accessories or a vehicle cover is installed/removed near the rear bumper
 - When the vehicle is being towed
- To prevent unintentional operation, turn the Hands Free Power Back Door operation setting off. (→P.185)
- **When reconnecting the 12-volt battery**
- To enable the power back door to operate properly, close the back door manually.
- **If the back door opener is inoperative**
- The back door can be unlocked from the inside.
- 1 Remove the cover.
- To prevent damage, cover the tip of the screwdriver with a rag.

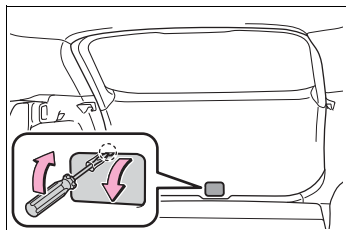

2 Loosen the screw and move the cover.

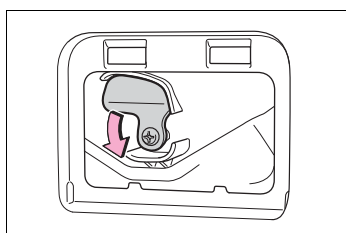

3 Move the lever.

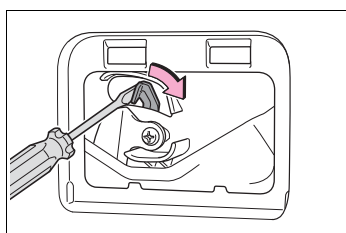

4 When installing, reverse the steps listed.

■ **Customization**

Some functions can be customized. (Customizable features: →P.570)

! WARNING

■ **Back door closer**

- In the event that the back door is left slightly open, the back door closer will automatically close it to the fully closed position. It takes several seconds before the back door closer begins to operate. Be careful not to catch fingers or anything else in the back door, as this may cause bone fractures or other serious injuries.

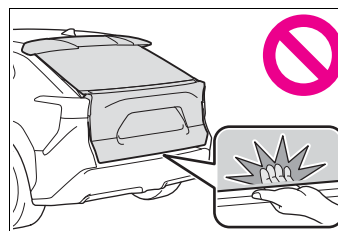

- Use caution when using the back door closer as it still operates when the power back door system is canceled.

■ **Power back door**

Observe the following precautions when operating the power back door.

Failure to do so may cause death or serious injury.

- Check the safety of the surrounding area to make sure there are no obstacles or anything that could cause any of your belongings to get caught.
- If anyone is in the vicinity, make sure they are safe and let them know that the back door is about to open or close.



WARNING

- If the power back door system is turned off while the back door is operating automatically, the automatic operation is stopped. The back door then has to be operated manually. Take extra care when on an incline, as the back door may open or close unexpectedly.
- If the operating conditions of the power back door are no longer met, a buzzer may sound and the back door may stop opening or closing. The back door then has to be operated manually. Take extra care when on an incline, as the back door may open or close abruptly.
- On an incline, the back door may suddenly shut after it opens. Make sure the back door is fully open and secure.
- In the following situations, the power back door may detect an abnormality and automatic operation may be stopped. In this case, the back door has to be operated manually. Take extra care when on an incline, as the back door may open or close abruptly.
- When the back door contacts an obstacle
- When the 12-volt battery voltage suddenly drops, such as when the power switch is turned to ON or the EV system is started during automatic operation

- If a bicycle carrier or similar heavy object is attached to the back door, the power back door may not operate, causing itself to malfunction, or the back door may suddenly shut again after being opened, causing someone's hands, arms, head or neck to be caught and injured. When installing an accessory part to the back door, using a genuine Toyota part is recommended.

Jam protection function

Observe the following precautions. Failure to do so may cause death or serious injury.

- Never use any part of your body to intentionally activate the jam protection function.
- The jam protection function may not work if something gets caught just before the back door fully closes. Be careful not to catch fingers or anything else.
- The jam protection function may not work depending on the shape of the object that is caught. Be careful not to catch fingers or anything else.

Hands Free Power Back Door (if equipped)

Observe the following precautions when operating the Hands Free Power Back Door. Failure to do so may cause death or serious injury.

- Check the safety of the surrounding area to make sure there are no obstacles or anything that could cause any of your belongings to get caught.

⚠ WARNING

- When putting your foot near the lower center part of the rear bumper and moving it from the rear bumper, be careful not to touch the exhaust pipes until they have cooled down sufficiently, as touching hot exhaust pipes can cause burns.
- Do not leave the electronic key within the effective range (detection area) of the luggage compartment.

⚠ NOTICE

■ Back door spindles

The back door is equipped with spindles that hold the back door in place. Observe the following precautions. Failure to do so may cause damage to the back door spindle, resulting in malfunction.

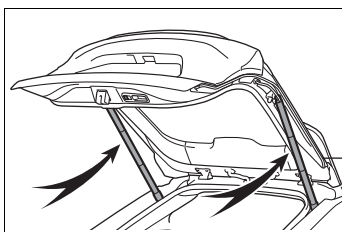

- Do not attach any foreign objects, such as stickers, plastic sheets, or adhesives to the spindle rod.
- Do not touch the spindle rod with gloves or other fabric items.
- Do not attach any accessories other than genuine Toyota parts to the back door.
- Do not place your hand on the spindle or apply lateral forces to it.

■ To prevent back door closer malfunction

Do not apply excessive force to the back door while the back door closer is operating. Applying excessive force may cause the back door closer to malfunction.

■ To prevent damage to the power back door

- Make sure that there is no ice between the back door and frame that would prevent movement of the back door. Operating the power back door when excessive load is present on the back door may cause a malfunction.
- Do not apply excessive force to the back door while the power back door is operating.
- Take care not to damage the sensors (installed on the right and left edges of the power back door) with a knife or other sharp object. If the sensor is disconnected, the power back door will not close automatically.

■ Close & lock function

When closing the power back door using the close & lock function, a different buzzer than the normal one will sound before the operation begins.

To check that the operation has started correctly, check that a different buzzer than the normal one has sounded.

Additionally, when the power back door is fully closed and locked, operation signals will indicate that all of the doors have been locked.

Before leaving the vehicle, make sure that the operation signals have operated and that all of the doors are locked.

 NOTICE

■ **Hands Free Power Back Door precautions (if equipped)**

The kick sensor is located behind lower center part of the rear bumper. Observe the following to ensure that the Hands Free Power Back Door function operates properly:

- Keep the lower center part of the rear bumper clean at all times.
If the lower center part of the rear bumper is dirty or covered with snow, the kick sensor may not operate. In this situation, clean off the dirt or snow, move the vehicle from the current position and then check if the kick sensor operates. If it does not operate, have the vehicle inspected by your Toyota dealer.
- Do not apply coatings that have a rain clearing (hydrophilic) effect, or other coatings, to the lower center part of the rear bumper.
- Do not park the vehicle near objects that may move and contact the lower center part of the rear bumper, such as grass or trees.
If the vehicle has been parked for a while near objects that may move and contact the lower center part of the rear bumper, such as grass or trees, the kick sensor may not operate. In this situation, move the vehicle from the current position and then check if the kick sensor operates. If it does not operate, have the vehicle inspected by your Toyota dealer.

- Do not subject the kick sensor or its surrounding area to a strong impact.
If the kick sensor or its surrounding area has been subjected to a strong impact, the kick sensor may not operate properly. If the kick sensor does not operate in the following situations, have the vehicle inspected by your Toyota dealer.
 - The kick sensor or its surrounding area has been subjected to a strong impact.
 - The lower center part of the rear bumper is scratched or damaged.
- Do not disassemble the rear bumper.
- Do not attach stickers to the rear bumper.
- Do not paint the rear bumper.
- If a bicycle carrier or similar heavy object is attached to the power back door, disable the Hands Free Power Back Door.

Changing settings of the power back door system (vehicles with power back door)

The settings of the power back door system can be changed by displaying the “Vehicle Settings”  screen from the setting screen of the multi-information display. (→P.158)

The changed power back door settings are not reset by turning the power switch to OFF. In order to

4
Before driving

restore the original settings, they need to be changed back on the setting screen of the multi-information display.

Adjusting the open position of the back door (vehicles with power back door)

The open position of the power back door can be adjusted.

- 1 Stop the back door in the desirable position. (→P.175)
- 2 Press and hold the power back door switch on the back door for approximately 2 seconds.

When the settings are completed, the buzzer sounds 4 times.

When opening the back door the next time, the back door will stop at that position.

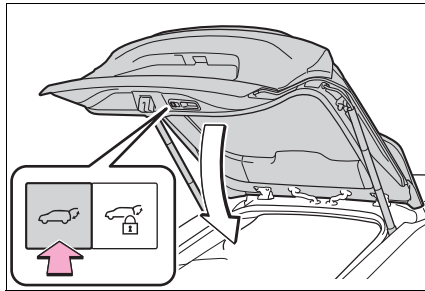

Canceling the adjusted open position of the back door

Press and hold the power back door switch on the back door for approximately 7 seconds.

After the buzzer sounds 4 times, it sounds twice more. When the power back door does the opening operation the next time, the door will open to the initial settings position.

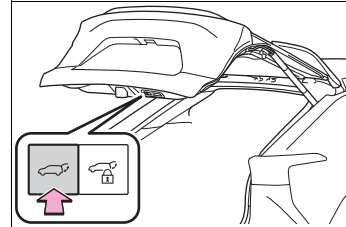

Customization

The opening position can be set with the multi-information display. (→P.570)

Priority for the stop position is given to the last position set by either the power back door switch on the back door or multi-information display.

Smart key system

The following operations can be performed simply by carrying the electronic key on your person, for example in your pocket. The driver should always carry the electronic key.

- Locks and unlocks the doors* (→P.167)
- Locks and unlocks the back door* (→P.173)
- Starts the EV system (→P.231)

■ Antenna location

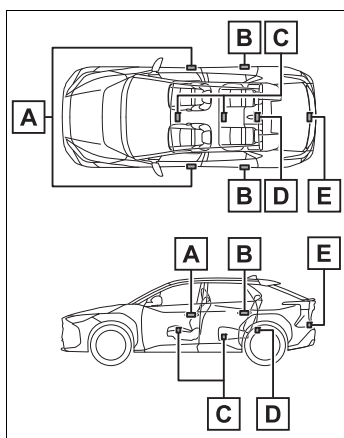

- A** Antennas outside the cabin (driver's side/front passenger's side [if equipped])
- B** Antennas outside the cabin (rear) (if equipped)
- C** Antennas inside the cabin
- D** Antenna inside the luggage compartment

partment

- E** Antenna outside the luggage compartment

■ Effective range (areas within which the electronic key is detected)

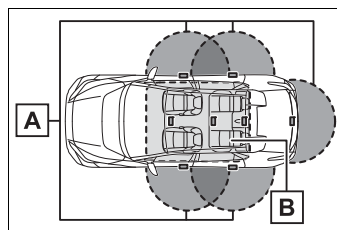

- A** When locking or unlocking the doors

The system can be operated when the electronic key is within about 2.3 ft. (0.7 m) of the driver's door handle, front passenger's door handle (if equipped), rear door handles (if equipped) and back door opener switch (if equipped). (Only the doors detecting the key can be operated.)

- B** When starting the EV system or changing power switch modes

The system can be operated when the electronic key is inside the vehicle.

■ If an alarm sounds or a warning message is displayed

An alarm sounds and warning message displays shown on the multi-information display are used to protect against unexpected accidents or theft of the vehicle resulting from erroneous operation. When a warning message is displayed, take appropriate measures based on the displayed message.

When only an alarm sounds, circumstances and correction procedures are as follows.

- When an exterior alarm sounds once for 5 seconds

| Situation | Correction procedure |
|--|--|
| An attempt was made to lock the vehicle while a door was open. | Close all of the doors and lock the doors again. |

- When an interior alarm pings continuously

| Situation | Correction procedure |
|--|---|
| The power switch was turned to ACC while the driver's door was open (or the driver's door was opened while the power switch was in ACC). | Turn the power switch to OFF and close the driver's door. |

■ Battery-saving function



The battery-saving function will be activated in order to prevent the electronic key battery and the 12-volt battery from being discharged while the vehicle is not in operation for a long time.

- In the following situations, the smart key system may take some time to unlock the doors.
- The electronic key has been left in an area of approximately 11.5 ft. (3.5 m) of the outside of the vehicle for 2 minutes or longer.
- The smart key system has not been used for 5 days or longer.
- If the smart key system has not been used for 14 days or longer, the doors cannot be unlocked at any doors except the driver's door. In this case, take hold of the driver's door handle, or use the wireless remote control or the

mechanical key, to unlock the doors.

■ Turning an electronic key to battery-saving mode

- When battery-saving mode is set, battery depletion is minimized by stopping the electronic key from receiving radio waves.

Press  twice while pressing and holding .

Confirm that the electronic key indicator flashes 4 times.

While the battery-saving mode is set, the smart key system cannot be used. To cancel the function, press any of the electronic key buttons.

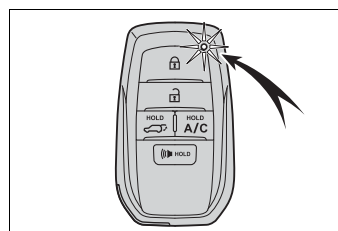

- Electronic keys that will not be used for long periods of time can be set to the battery-saving mode in advance.

■ Conditions affecting operation

The smart key system uses weak radio waves. In the following situations, the communication between the electronic key and the vehicle may be affected, preventing the smart key system, wireless remote control and immobilizer system from operating properly.

- When the electronic key battery is depleted
- Near a TV tower, electric power plant, gas station, radio station, large display, airport or other facility that generates strong radio waves or electrical noise
- When the electronic key is in con-

- tact with, or is covered by the following metallic objects
- Cards to which aluminum foil is attached
 - Cigarette boxes that have aluminum foil inside
 - Metallic wallets or bags
 - Coins
 - Hand warmers made of metal
 - Media such as CDs and DVDs
- When another wireless key (that emits radio waves) is being used nearby
 - When carrying the electronic key together with the following devices that emit radio waves
 - Portable radio, cellular phone, cordless phone or other wireless communication devices
 - Another electronic key or a wireless key that emits radio waves
 - Personal computers or personal digital assistants (PDAs)
 - Digital audio players
 - Portable game systems
 - If window tint with a metallic content or metallic objects are attached to the rear window
 - When the electronic key is placed near a battery charger or electronic devices
 - When the vehicle is parked in a pay parking spot where radio waves are emitted.
- **Note for the entry function**
- Even when the electronic key is within the effective range (detection areas), the system may not operate properly in the following cases:
 - The electronic key is too close to the window or outside door handle, near the ground, or in a high place when the doors are locked or unlocked.
 - The electronic key is on the instrument panel, luggage cover or floor, or in the door pockets or glove box when the EV system is started or power switch modes are changed.
 - Do not leave the electronic key on top of the instrument panel or near the door pockets when exiting the vehicle. Depending on the radio wave reception conditions, it may be detected by the antenna outside the cabin and the door will become lockable from the outside, possibly trapping the electronic key inside the vehicle.
 - As long as the electronic key is within the effective range, the doors may be locked or unlocked by anyone. However, only the doors detecting the electronic key can be used to lock or unlock the vehicle.
 - Even if the electronic key is not inside the vehicle, it may be possible to start the EV system if the electronic key is near the window.
 - The doors may unlock if a large amount of water splashes on the door handle, such as in the rain or in a car wash when the electronic key is within the effective range. (The doors will automatically be locked after approximately 60 seconds if the doors are not opened and closed.)
 - If the wireless remote control is used to lock the doors when the electronic key is near the vehicle, there is a possibility that the door may not be unlocked by the entry function. (Use the wireless remote control to unlock the doors.)
 - Touching the door lock sensor while wearing gloves may delay or prevent lock operation. Remove the gloves and touch the lock sensor again.
 - When the lock operation is performed using the lock sensor, recognition signals will be shown up to two consecutive times. After this, no recognition signals will be given.
 - If the door handle becomes wet while the electronic key is within the effective range, the door may

lock and unlock repeatedly. In that case, follow the following correction procedures to wash the vehicle:

- Place the electronic key in a location 6 ft. (2 m) or more away from the vehicle. (Take care to ensure that the key is not stolen.)
- Set the electronic key to battery-saving mode to disable the smart key system. (→P.188)
- If the electronic key is inside the vehicle and a door handle becomes wet during a car wash, a message may be shown on the multi-information display and a buzzer will sound outside the vehicle. To turn off the alarm, lock all the doors.
- The lock sensor may not work properly if it comes into contact with ice, snow, mud, etc. Clean the lock sensor and attempt to operate it again.
- A sudden approach to the effective range or door handle may prevent the doors from being unlocked. In this case, return the door handle to the original position and check that the doors unlock before pulling the door handle again.
- If there is another electronic key in the detection area, it may take slightly longer to unlock the doors after the door handle is gripped.

■ When the vehicle is not driven for extended periods

- To prevent theft of the vehicle, do not leave the electronic key within 6 ft. (2 m) of the vehicle.
- The smart key system can be deactivated in advance. (→P.569)
- Battery-saving mode can reduce the power consumption of electronic keys. (→P.188)

■ To operate the system properly

Make sure to carry the electronic key when operating the system. Do not get the electronic key too close

to the vehicle when operating the system from the outside of the vehicle.

Depending on the position and holding condition of the electronic key, the key may not be detected correctly and the system may not operate properly. (The alarm may go off accidentally, or the door lock prevention may not operate.)

■ If the smart key system does not operate properly

- If the doors cannot be locked or unlocked, perform the following.
 - Bring the electronic key close to the door handle and perform a lock or unlock operation.
 - Use the wireless remote control.

If the doors cannot be locked or unlocked by perform the above, use the mechanical key. (→P.539)

However, if the mechanical key is used while the alarm system is set, the warning will sound. (→P.69)

- If the EV system cannot be started, refer to P.540

■ Customization

Settings (e.g. smart key system) can be changed.

(Customizable features: →P.569)

If the smart key system has been deactivated in a customized setting, refer to the explanations for the following operations.

- Locking and unlocking the doors: Use the wireless remote control or mechanical key. (→P.167, 539)
- Starting the EV system and changing power switch modes: →P.540
- Stopping the EV system: →P.233

**WARNING****■ Caution regarding interference with electronic devices**

- People with implantable cardiac pacemakers, cardiac resynchronization therapy-pacemakers or implantable cardioverter defibrillators should keep away from the smart key system antennas. (→P.187)

The radio waves may affect the operation of such devices. If necessary, the entry function can be disabled. Ask your Toyota dealer for details, such as the frequency of radio waves and timing of the emitted radio waves. Then, consult your doctor to see if you should disable the entry function.

- User of any electrical medical device other than implantable cardiac pacemakers, cardiac resynchronization therapy-pacemakers or implantable cardioverter defibrillators should consult the manufacturer of the device for information about its operation under the influence of radio waves.

Radio waves could have unexpected effects on the operation of such medical devices.

Ask your Toyota dealer for details for disabling the entry function.

Front seats

The seats can be adjusted (longitudinally, vertically, etc.). Adjust the seat to ensure the correct driving posture.

Adjustment procedure

- ▶ Manual seat (driver and passenger seat)

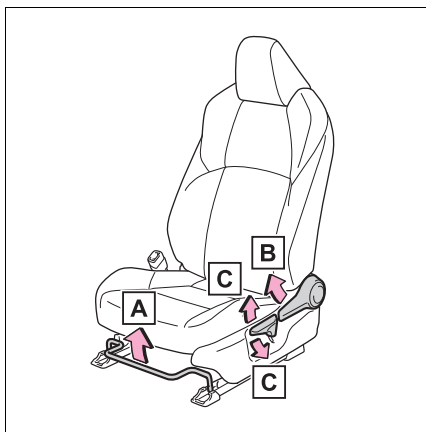

- A** Seat position adjustment lever
- B** Seatback angle adjustment lever
- C** Vertical height adjustment lever

- ▶ Power seat (driver seat only)

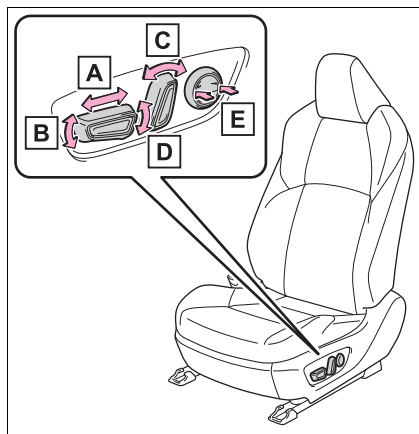

- A** Seat position adjustment switch
- B** Seat cushion (front) angle adjustment switch
- C** Seatback angle adjustment switch
- D** Vertical height adjustment switch
- E** Lumbar support adjustment switch

■ When adjusting the seat

- Make sure that any surrounding passengers or objects are not contact the seat.
- Take care when adjusting the seat so that the head restraint does not touch the ceiling and sun visor.

⚠ WARNING

■ When adjusting the seat position

- Take care when adjusting the seat position to ensure that other passengers are not injured by the moving seat.

- Do not put your hands under the seat or near the moving parts to avoid injury. Fingers or hands may become jammed in the seat mechanism.
- Make sure to leave enough space around the feet so they do not get stuck.
- Manual seat only: After adjusting the seat, make sure that the seat is locked in position.

■ **Seat adjustment**

To reduce the risk of sliding under the lap belt during a collision, do not recline the seat more than necessary.

If the seat is too reclined, the lap belt may slide past the hips and apply restraint forces directly to the abdomen, or your neck may contact the shoulder belt, increasing the risk of death or serious injury in the event of an accident. Adjustments should not be made while driving as the seat may unexpectedly move and cause the driver to lose control of the vehicle.

Rear seats

Reclining adjustments and folding the seatbacks can be done with lever operation.

Adjustment procedure

Pull the seatback angle adjustment lever **A**, and adjust the seatback angle.

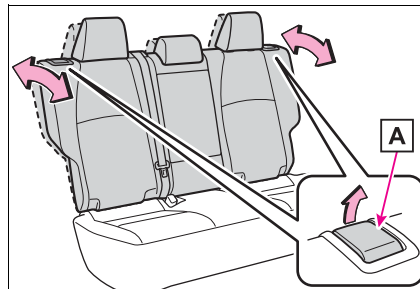

4

Before driving

! WARNING

■ **When operating the seatback**

Observe the following precautions. Failure to do so may cause death or serious injury.

- Keep other passengers from being hit with the seatback.
- Do not bring your hands close to the moving parts or between the seats, as well as do not let any part of your body get caught.

⚠ WARNING

- After adjusting the seat, make sure that the seat is locked in position. If the seatback is not securely locked, the red marking will be visible. Make sure that the red marking is not visible.

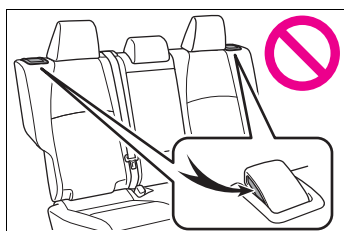

Folding down the rear seatbacks

■ **Before folding down the seatbacks**

- 1 Park the vehicle in a safe place.
Apply the parking brake (→P.243) and shift the shift position to P. (→P.237)
- 2 Adjust the position of the front seat and the angle of the seatback. (→P.192)
Depending on the position of the front seat, if the seatback is folded backward, it may interfere with the operation of the rear seat.
- 3 Lower the head restraint of the rear center seat. (→P.196)
- 4 Stow the armrest of the rear seat if it is pulled out. (→P.437)

This step is not necessary when operating the left side seat only.

■ **Folding down the rear seatbacks**

While pulling the seatback angle adjustment lever **A**, fold the seatback down.

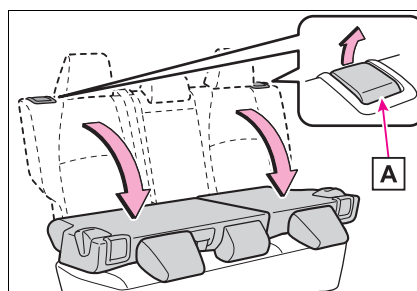

■ **Returning the rear seatbacks**

To avoid trapping the seat belt between the seat and the inside of the vehicle, pass the seat belt outside the seat belt guide **A** and then return the seatback securely to the locked position.

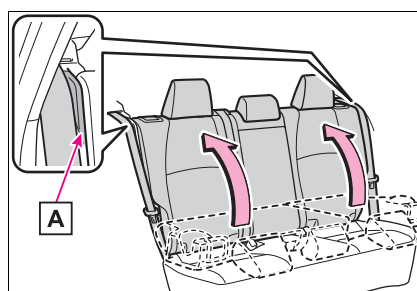

⚠ WARNING

■ **When folding the rear seatbacks down**

Observe the following precautions. Failure to do so may result in death or serious injury.

⚠ WARNING

- Do not attempt to fold the seatbacks down while driving.
- Stop the vehicle on level ground, set the parking brake and shift the shift position to P.
- Do not allow anyone to sit on a folded seatback or in the luggage compartment while driving.
- Do not allow children to enter the luggage compartment.
- Do not operate the rear seat if it is occupied.
- Be careful not to get feet or hands caught in the moving parts or joints of the seats during operation.
- Do not allow children to operate the seat.

■ After returning the rear seatback to the upright position

Observe the following precautions. Failure to do so may result in death or serious injury.

- Make sure that the seatback is securely locked in position by lightly pushing it back and forth. If the seatback is not securely locked, the red marking will be visible on the seatback lock release lever. Make sure that the red marking is not visible.

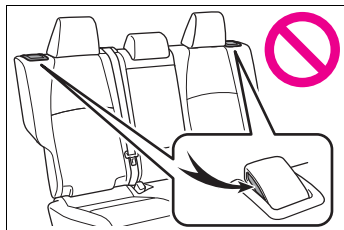

- Check that the seat belts are not twisted or caught in the seatback.

Head restraints

Head restraints are provided for all seats.

⚠ WARNING

■ Head restraint precautions

Observe the following precautions regarding the head restraints. Failure to do so may result in death or serious injury.

- Use the head restraints designed for each respective seat.
- Adjust the head restraints to the correct position at all times.
- After adjusting the head restraints, push down on them and make sure they are locked in position.
- Do not drive with the head restraints removed.

Vertical adjustment

■ Front seats

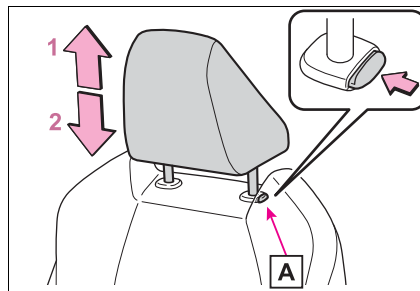

- 1 Up**
Pull the head restraints up.
- 2 Down**
Push the head restraint down while pressing the lock release button **A**.

■ Rear center seat

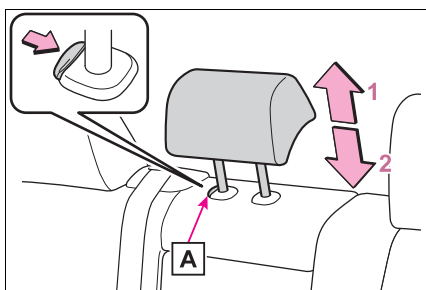

- 1 Up
Pull the head restraints up.
- 2 Down
Push the head restraint down while pressing the lock release button **A**.

■ Rear outer seats

Head restraints cannot be adjusted.

■ Adjusting the height of the head restraints (front seats)

Make sure that the head restraints are adjusted so that the center of the head restraint is closest to the top of your ears.

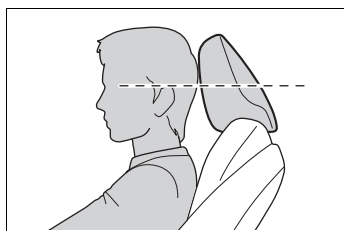

■ Adjusting the rear center seat head restraint

Always raise the head restraint one level from the stowed position when using.

Removing the head restraints

■ Front seats

Pull the head restraint up while pressing the lock release button

A.

If the head restraint touches the ceiling, making the removal difficult, change the seat height or angle. (→P.192)

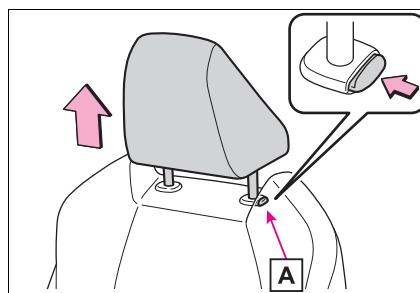

■ Rear center seat

Pull the head restraint up while pressing the lock release button

A.

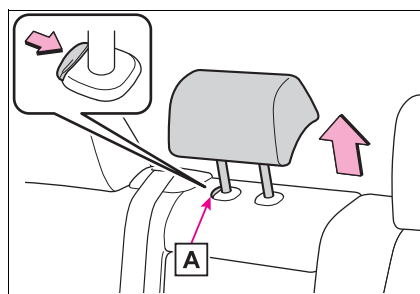

■ Rear outer seats

- 1 Pull the seatback lock release lever **A** and fold down the seatback until it reaches the position where

the head restraints can be removed.

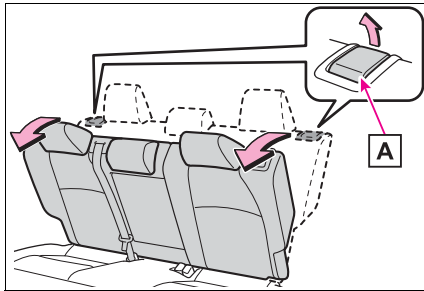

- 2 Pull the head restraint up while pressing the lock release button **B**.

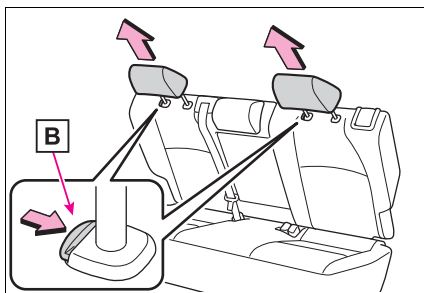

Installing the head restraints

■ Front seats

Align the head restraint with the installation holes and push it down to the lock position.

Press and hold the lock release button **A** when lowering the head restraint.

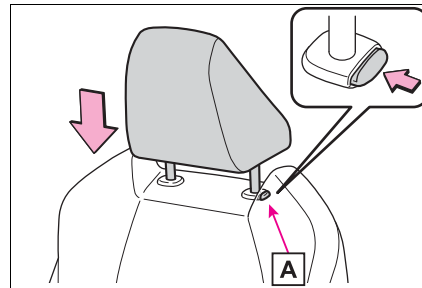

■ Rear center seat

Align the head restraint with the installation holes and push it down to the lock position.

Press and hold the lock release button **A** when lowering the head restraint.

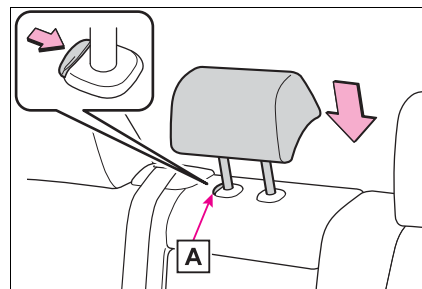

■ Rear outer seats

- 1 Pull the seatback lock release lever **A** and fold down the seatback until it reaches the position where

4

Before driving

the head restraints can be installed.

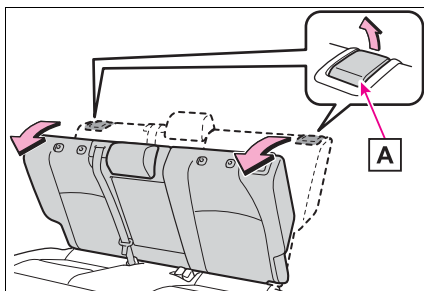

- 2 Align the head restraint with installation holes and push it down to the lock position.

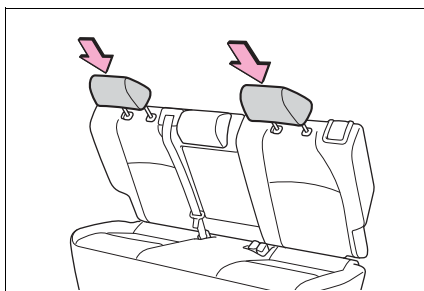

Steering wheel

Adjustment procedure

- 1 Hold the steering wheel and push the lever down.

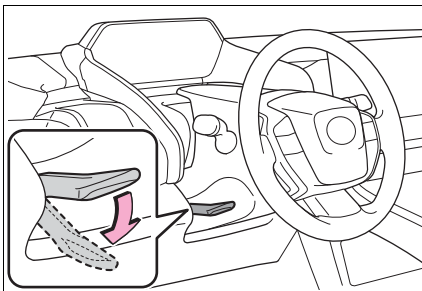

- 2 Adjust to the ideal position by moving the steering wheel horizontally and vertically.

After adjustment, pull the lever up to secure the steering wheel.

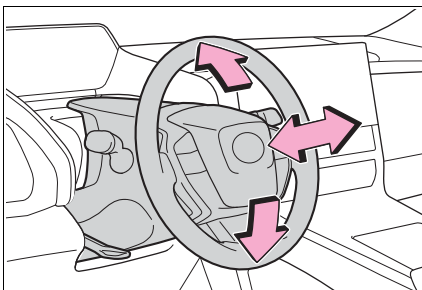

⚠ WARNING

■ **Caution while driving**

Do not adjust the steering wheel while driving. Doing so may cause the driver to mishandle the vehicle and cause an accident, resulting in death or serious injury.

■ **After adjusting the steering wheel**

Make sure that the steering wheel is securely locked. Otherwise, the steering wheel may move suddenly, possibly causing an accident, and resulting in death or serious injury. Also, the horn may not sound if the steering wheel is not securely locked.

Sounding the horn

To sound the horn, press on or close to the  mark.

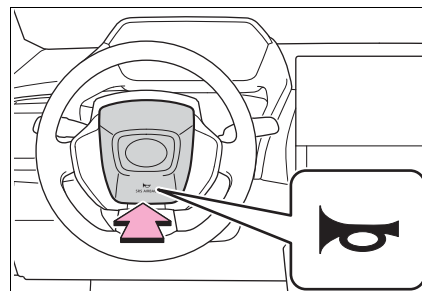

4

Before driving

Inside rear view mirror*

*: If equipped

The rear view mirror's position can be adjusted to enable sufficient confirmation of the rear view.

Adjusting the height of rear view mirror

The height of the rear view mirror can be adjusted to suit your driving posture.

Adjust the height of the rear view mirror by moving it up and down.

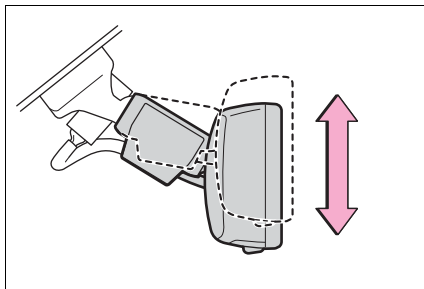

⚠ WARNING

■ Caution while driving

Do not adjust the position of the mirror while driving. Doing so may lead to mishandling of the vehicle and cause an accident, resulting in death or serious injury.

Anti-glare function (vehicles with manual anti-glare inside rear view mirror)

Reflected light from the headlights of vehicles behind can be reduced by operating the lever.

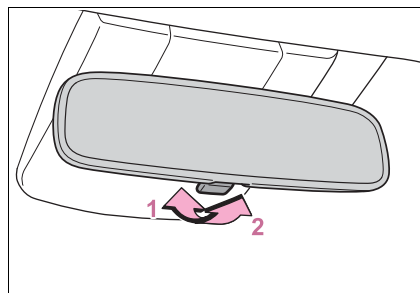

- 1 Normal position
- 2 Anti-glare position

Anti-glare function (vehicles with auto anti-glare inside rear view mirror)

Responding to the level of brightness of the headlights of vehicles behind, the reflected light is automatically reduced.

Changing automatic anti-glare function mode on/off

When the automatic anti-glare function is in ON mode, the indicator **A** illuminates.

The function will set to ON mode each time the power switch is turned to ON.

Pressing the button turns the function to OFF mode. (The indicator **A** also turns off.)

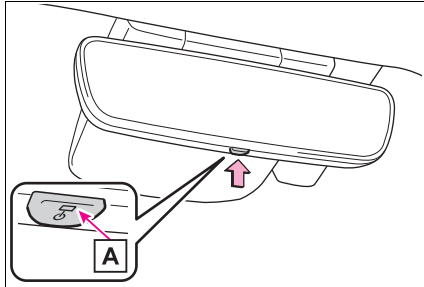

■ **To prevent sensor error (vehicles with auto anti-glare inside rear view mirror)**

To ensure that the sensors operate properly, do not touch or cover them.

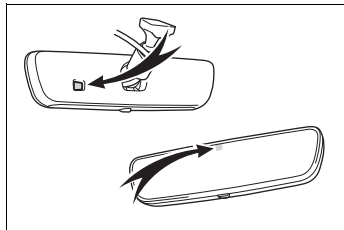

Digital Rear-view Mirror*

*: If equipped

The Digital Rear-view Mirror is a system that uses the camera on the rear of the vehicle and displays its image on the display of the Digital Rear-view Mirror.

The Digital Rear-view Mirror can be changed between optical mirror mode and digital mirror mode by operating the lever.

The Digital Rear-view Mirror allows the driver to see the rear view despite obstructions, such as the head restraints or luggage, ensuring rear visibility. Also, the rear seats are not displayed and privacy of the passengers is enhanced.

⚠ WARNING

Observe the following precautions. Failure to do so may result in death or serious injury.

■ **Before using the Digital Rear-view Mirror**

- Make sure to adjust the mirror before driving. (→P.203)
- Change to optical mirror mode and adjust the position of the Digital Rear-view Mirror so that the area behind your vehicle can be viewed properly.

⚠ WARNING

- Change to digital mirror mode and adjust the display settings.
- As the range of the image displayed by the Digital Rear-view Mirror is different from that of the optical mirror, make sure to check this difference before driving.

System components

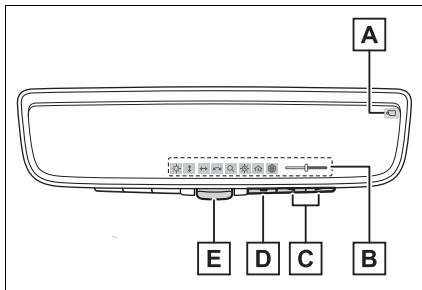

- A** Camera indicator
Indicates that the camera is operating normally.
- B** Icon display area
Displays icons, adjusting gauge, etc. (→P.203)
- C** Select/adjust button
Press to change the setting of the item you want to adjust.
- D** Menu button
Press to display the icon display area and select the item you want to adjust.
- E** Lever
Operate to change between digital mirror mode and optical mirror mode.

Changing modes

Operate the lever to change between digital mirror mode and optical mirror mode.

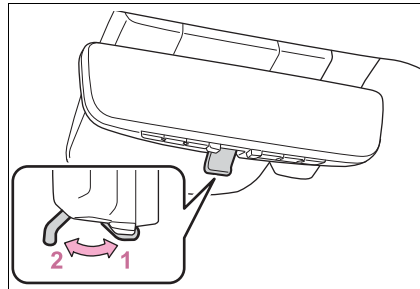

- 1** Digital mirror mode
Displays an image of the area behind the vehicle.
☑ will illuminate in this mode.
- 2** Optical mirror mode
Turns off the display of the Digital Rear-view Mirror allows it to be used as an optical mirror.

■ Digital mirror mode operating condition

The power switch is turned to ON.
When the power switch is changed from ON to OFF or ACC, the image will disappear after several seconds.

■ When using the Digital Rear-view Mirror in digital mirror mode

- If it is difficult to see the Digital Rear-view Mirror image because water, snow, mud, etc. is stuck to the camera lens, operate the rear camera washer (→P.253) or change to optical mirror mode.
- When the back door is open, the Digital Rear-view Mirror image may not display properly. Before driving, make sure the back door is closed.

- If the display is difficult to see due to reflected light, close the electronic sunshade for the panoramic moon roof (if equipped).
- Any of the following conditions may occur when driving in the dark, such as at night. None of them indicates that a malfunction has occurred.
 - Colors of objects in the displayed image may differ from their actual color.
 - Depending on the height of the lights of the vehicle behind, the area around the vehicle may appear white and blurry.
 - Automatic image adjustment for brighter surrounding image may cause flickering.

If it is difficult to see the displayed image or flickering bothers you, change to optical mirror mode.

- The Digital Rear-view Mirror may become hot while it is in digital mirror mode. This is not a malfunction.
- Depending on your physical condition or age, it may take longer than usual to focus on the displayed image. In this case, change to optical mirror mode.
- Do not let passengers stare at the displayed image when the vehicle is being driven, as doing so may cause motion sickness.

■ When the system malfunctions

If the symbol shown in the illustration is displayed when using the Digital Rear-view Mirror in digital mirror mode, the system may be malfunctioning. The symbol will disappear in a few seconds. Operate the lever, change to optical mirror mode and have the vehicle inspected by your Toyota dealer.

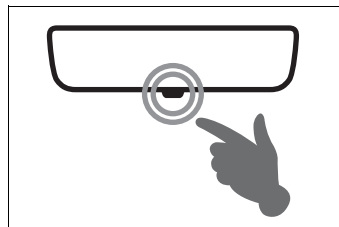

Adjusting the mirror

■ Adjusting the mirror height

The height of the rear view mirror can be adjusted to suit your driving posture.

Change to optical mirror mode, adjusting the height of the rear view mirror by moving it up and down.

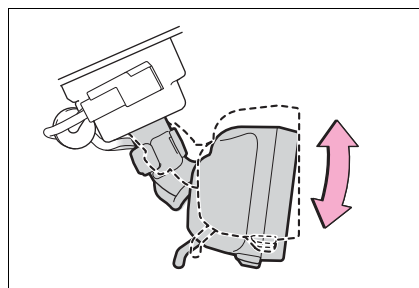



■ Display settings (digital mirror mode)

Settings of the display in the digital mirror mode, on/off operation of the automatic anti-glare function, etc. can be changed.



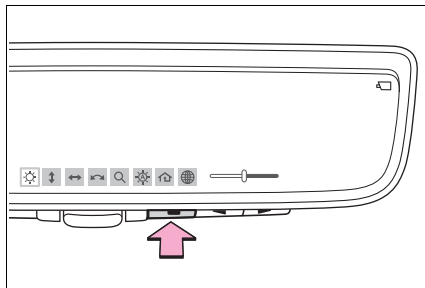

- 1 Press the menu button.



The icons will be displayed.



- 2 Press the menu button repeatedly and select the item you want to adjust.
- 3 Press  or  to change the setting.

The icons will disappear if a button is not operated for approximately 5 seconds or more.

| Icons | Settings |
|---|--|
|  | Select to adjust the brightness of the display. |
|  | Select to adjust the area displayed up/down. |
|  | Select to adjust the area displayed to the left/right. |
|  | Select to adjust the angle of the displayed image. |
|  | Select to zoom in/out the displayed image. |

| Icons | Settings |
|---|--|
|  | Select to enable/disable the automatic anti-glare function.* Responding to the brightness of the headlights of vehicles behind, the reflected light is automatically adjusted. The automatic anti-glare function is enabled each time the power switch is changed to ON. |
|  | Select to display Home-Link® Training Tutorial to assist customers to train their Garage Door Opener System. (→P.440) |
|  | Select to change the language of the Homelink® Training Tutorial. |

*: This is a function for the optical mirror mode, however, the setting can also be changed while using the digital mirror mode.

■ **Enabling/disabling the automatic anti-glare function (optical mirror mode)**

The automatic anti-glare function in the optical mirror mode can be enabled/disabled. The setting can be changed in both the digital mirror mode and the optical mirror mode.

- ▶ When using the digital mirror mode



→P.203

- ▶ When using the optical mirror mode

1 Press the menu button.

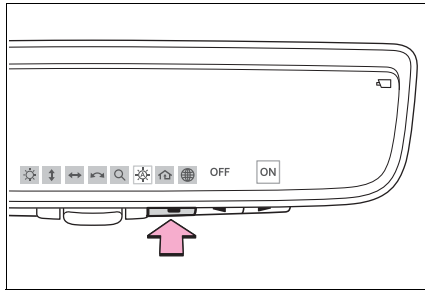
The setting display will be displayed.



2 Press  or  to enable (“ON”)/disable (“OFF”) the automatic anti-glare function.

The icons will disappear if a button is not operated for approximately 5 seconds or more.

■ **Adjusting the display (digital mirror mode)**

- The icons will disappear if a button is not operated for approximately 5 seconds or more.
- If the displayed image is adjusted, it may appear distorted. This is not a malfunction.
- If the brightness of the Digital Rear-view Mirror is set too high, it may cause eye strain. Adjust the Digital Rear-view Mirror to an appropriate brightness. If your eyes become tired, change to optical mirror mode.
- The brightness of the Digital Rear-view Mirror will change automatically according to the brightness of the area in front of your vehicle.

■ **To prevent the light sensors from malfunctioning**

To prevent the light sensors from

malfunctioning, do not touch or cover them.

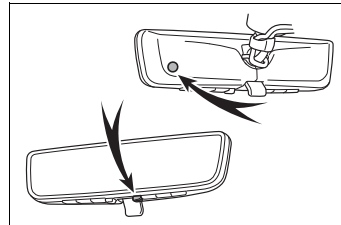

! WARNING

Observe the following precautions. Failure to do so may result in death or serious injury.

■ **While driving**

- Do not adjust the position of the Digital Rear-view Mirror or adjust the display settings while driving. Stop the vehicle and operate the Digital Rear-view Mirror control switches. Failure to do so may cause a steering wheel operation error, resulting in an unexpected accident.

- Always pay attention to the vehicle’s surroundings.

The size of the vehicles and other objects may look different when in digital mirror mode and optical mirror mode.

When backing up, make sure to directly check the safety of the area around your vehicle, especially behind the vehicle. Additionally, if a vehicle approaches from the rear in the dark, such as at night, the surrounding area may appear dim.

4
Before driving

⚠ WARNING

■ **To prevent causes of fire**

If the driver continues using the Digital Rear-view Mirror while smoke or odor comes from the mirror, it may result in fire. Stop using the system immediately and contact your Toyota dealer.

Cleaning the Digital Rear-view Mirror

■ **Cleaning the mirror surface**

If the mirror surface is dirty, the image on the display may be difficult to see.

Wipe the mirror surface gently using a soft dry cloth.

■ **Cleaning the camera**

If it is difficult to see the Digital Rear-view Mirror image because water, snow, mud, etc. is stuck to the camera lens, operate the rear camera washer or change to optical mirror mode. (→P.253)

■ **The camera**

The camera for the Digital Rear-view Mirror is located as shown.

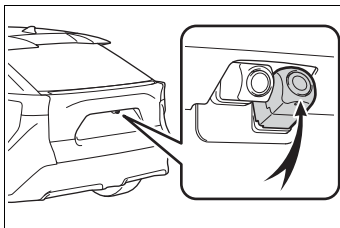

■ **Cleaning the camera with washer fluid**

- When cleaning the camera, it may be difficult to see the image due to

the washer fluid. Therefore, take care in the surrounding area while driving.

- If washer fluid remains on the camera lens surface after cleaning, the image may be difficult to see at night due to the height or inclination of the headlights of the vehicle behind. In this case, change to optical mirror mode.
- Some dirt may not be removed completely after cleaning. In this case, rinse the camera lens with a large quantity of water and then wipe it clean with a soft cloth dampened with water.
- Washer fluid is sprayed onto the camera lens surface. Therefore, the ice, snow, etc. adhering around the camera cannot be removed.

⚠ NOTICE

■ **To prevent the Digital Rear-view Mirror from malfunctioning**

- Do not use detergents, such as thinner, benzene, and alcohol to clean the mirror. They may discolor, deteriorate or damage the mirror surface.
- Do not smoke, use matches, use cigarette lighters or allow open flames near the mirror. It may damage the mirror or cause a fire.
- Do not remove, disassemble or modify the mirror.
- **To prevent the camera from malfunctioning**
- Observe the following precautions, otherwise the Digital Rear-view Mirror may not operate properly.

 NOTICE

- Do not strike or hit the camera or subject it to a strong impact, as the camera installation position and angle may be changed.
- Do not remove, disassemble or modify the camera.
- When washing the camera, rinse it with a large quantity of water and then wipe it clean with a soft cloth dampened with water.
Do not strongly rub the camera lens, as it may be scratched and will not be able to transmit a clear image.
- Do not allow organic solvent, car wax, window cleaner or glass coat to adhere to the camera cover. If this happens, wipe it off as soon as possible.
- Do not apply hot water to the camera in cold weather, as the sudden change of temperature may cause the camera to not operate properly.
- When using a high pressure washer to wash the vehicle, do not directly spray the camera and its surrounding area, as doing so may cause the camera to not operate properly.
- Do not subject the camera to a strong impact as this could cause a malfunction.
If this happens, have the vehicle inspected by your Toyota dealer as soon as possible.

- Do not block the vent holes of the mirror. Otherwise, the mirror may be hot, leading to a malfunction or a fire.

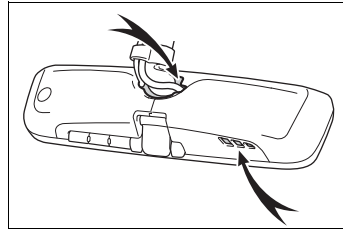





If you notice any symptoms

If you notice any of the following symptoms, refer to the following table for the likely cause and the solution.

If the symptom is not resolved by the solution, have the vehicle inspected by your Toyota dealer.

| Symptom | Likely cause | Solution |
|--------------------------------|---|--|
| The image is difficult to see. | The mirror surface is dirty. | Clean the mirror surface gently, using a soft dry cloth. |
| | Sunlight or headlights are shining directly into the Digital Rear-view Mirror. | Change to optical mirror mode. (If the light is coming through the panoramic moon roof [if equipped], close the electronic sunshade.) |
| | <ul style="list-style-type: none"> • The vehicle is in a dark area. • The vehicle is near a TV tower, broadcasting station, electric power plant, or other location where strong radio waves or electrical noise may be present. • The temperature around the camera is extremely high/low. • The ambient temperature is extremely low. • It is raining or humid. • Sunlight or headlights are shining directly into the camera lens. • The vehicle is under fluorescent lights, sodium lights, mercury lights, etc. | Change to optical mirror mode. (Change back to digital mirror mode when the conditions have improved.) |
| | Foreign matters such as water droplets or dust is on the camera lens. | <ul style="list-style-type: none"> • Operate the dedicated camera cleaning washer and clean the camera lens. (→P.253) • Change to optical mirror mode. |

| Symptom | Likely cause | Solution |
|--|--|---|
| The image is out of alignment. | The back door is not fully closed. | Fully close the back door. |
| | The camera or its surrounding area has received a strong impact. | Change to optical mirror mode and have the vehicle inspected by your Toyota dealer. |
| The display is dim and  is displayed. | The system may be malfunctioning. | Change to optical mirror mode and have the vehicle inspected by your Toyota dealer. |
|  goes off. | | |
|  is displayed. | The Digital Rear-view Mirror is extremely hot. (The display will gradually become more dim. If the temperature continues to increase, the Digital Rear-view Mirror will turn off.) | Reducing the cabin temperature is recommended to reduce the temperature of the mirror. ( will disappear when the mirror becomes cool.) If  does not disappear even though the mirror is cool, have the vehicle inspected by your Toyota dealer. |
| The lever cannot be operated properly. | The lever may be malfunctioning. | Change to optical mirror mode and have the vehicle inspected by your Toyota dealer. (To change to optical mirror mode, press and hold the menu button for approximately 10 seconds.) |

Outside rear view mirrors

The rear view mirror's position can be adjusted to enable sufficient confirmation of the rear view.

Defogging the mirrors

The outside rear view mirrors can be cleared using the mirror defoggers. Turn on the rear window defogger to turn on the outside rear view mirror defoggers. (→P.404)

⚠ WARNING

Important points while driving

Observe the following precautions while driving. Failing to do so may result in loss of control of the vehicle and cause an accident, resulting in death or serious injury.

- Do not adjust the mirrors while driving.
- Do not drive with the mirrors folded.
- Both the driver and passenger side mirrors must be extended and properly adjusted before driving.

When the mirror defoggers are operating

Do not touch the rear view mirror surfaces, as they can become very hot and burn you.

Adjustment procedure

- 1 To select a mirror to adjust, turn the switch.

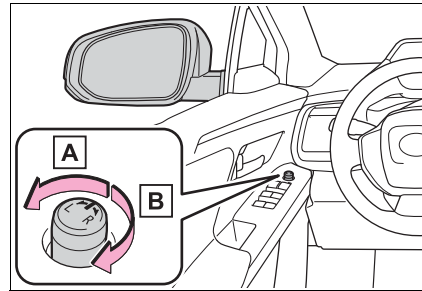

A Left

B Right

- 2 To adjust the mirror, operate the switch.

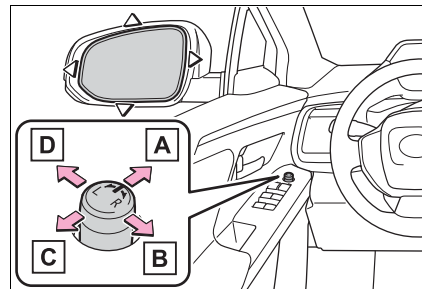

A Up

B Right

C Down

D Left

Mirror angle can be adjusted when

The power switch is in ACC or ON.

Folding the mirrors

Push the mirror back in the

direction of the vehicle's rear.

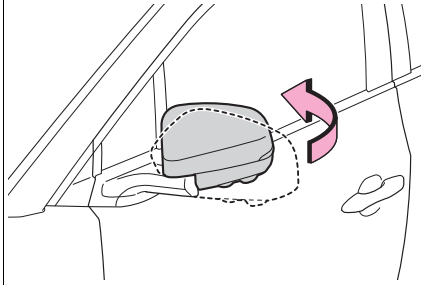

4

Before driving

Power windows

Opening and closing the power windows

The power windows can be opened and closed using the switches.

Operating the switch moves the side windows as follows:

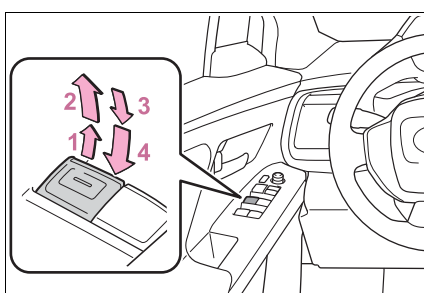

- 1 Closing
- 2 One-touch closing*
- 3 Opening
- 4 One-touch opening*

*: To stop the side window partway, operate the switch in the opposite direction.

■ The power windows can be operated when

The power switch is in ON.

■ Operating the power windows after turning the EV system off

The power windows can be operated for approximately 45 seconds even after the power switch is turned to ACC or OFF. They cannot, however, be operated once either front door is opened.

■ Jam protection function

If an object becomes jammed between the side window and the

window frame while the side window is closing, side window movement is stopped and the side window is opened slightly.

■ Catch protection function

If an object becomes caught between the door and side window while the side window is opening, side window movement is stopped.

■ When the power window cannot be opened or closed

When the jam protection function or catch protection function operates unusually and the side window cannot be opened and closed, perform the following operations with the power window switch of that door.

- Stop the vehicle. With the power switch in ON, within 4 seconds of the jam protection function or catch protection function activating, continuously operate the power window switch in the one-touch closing direction or one-touch opening direction so that the side window can be opened and closed.
- If the side window cannot be opened and closed even when performing the above operations, perform the following procedure for function initialization.
 - 1 Turn the power switch to ON.
 - 2 Pull and hold the power window switch in the one-touch closing direction and completely close the side window.
 - 3 Release the power window switch for a moment, resume pulling the switch in the one-touch closing direction, and hold it there for approximately 6 seconds or more.
 - 4 Press and hold the power window switch in the one-touch opening direction. After the side window is completely opened, continue holding the switch for an additional 1 second or more.

- 5 Release the power window switch for a moment, resume pushing the switch in the one-touch opening direction, and hold it there for approximately 4 seconds or more.
- 6 Pull and hold the power window switch in the one-touch closing direction again. After the side window is completely closed, continue holding the switch for a further 1 second or more.

If you release the switch while the side window is moving, start again from the beginning.

If the side window reverses and cannot be fully closed or opened, have the vehicle inspected by your Toyota dealer.

■ **Door lock linked power window operation**

- The power windows can be opened and closed using the mechanical key.* (→P.540)
- The power windows can be opened using the wireless remote control.* (→P.167)
- The alarm may be triggered if the alarm is set and the power window is closed using the door lock linked power window operation function. (→P.69)

*: These settings must be customized at your Toyota dealer.

■ **Power window open reminder function**

The buzzer sounds and a message is shown on the multi-information display when the power switch is turned to OFF and the driver's door is opened with the power windows open.

■ **Customization**

Some functions can be customized. (Customizable features: →P.571)

⚠ WARNING

Observe the following precautions. Failing to do so may result in death or serious injury.

■ **Closing the power windows**

- The driver is responsible for all the power window operations, including the operation for the passengers. In order to prevent accidental operation, especially by a child, do not let a child operate the power windows. It is possible for children and other passengers to have body parts caught in the power window. Also, when riding with a child, it is recommended to use the window lock switch. (→P.214)
- Check to make sure that all passengers do not have any part of their body in a position where it could be caught when a power window is being operated.

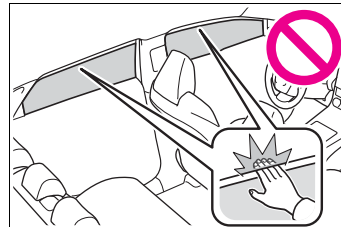

- When using the wireless remote control or mechanical key and operating the power windows, operate the power window after checking to make sure that there is no possibility of any passenger having any of their body parts caught in the side window. Also, do not let a child operate the power window by the wireless remote control or mechanical key. It is possible for children and other passengers to get caught in the power window.

⚠ WARNING

- When exiting the vehicle, turn the power switch to OFF, carry the key and exit the vehicle along with the child. There may be accidental operation, due to mischief, etc., that may possibly lead to an accident.

■ Jam protection function

- Never use any part of your body to intentionally activate the jam protection function.

- The jam protection function may not work if something gets jammed just before the side window is fully closed. Be careful not to get any part of your body jammed in the side window.

■ Catch protection function

- Never use any part of your body or clothing to intentionally activate the catch protection function.

- The catch protection function may not work if something gets caught just before the side window is fully opened. Be careful not to get any part of your body or clothing caught in the side window.

Preventing accidental operation (window lock switch)

This function can be used to prevent children from accidentally opening or closing a passenger window.

Press the switch.

The indicator **A** will come on and the passenger windows will be

locked.

The passenger windows can still be opened and closed using the driver's switch even if the lock switch is on.

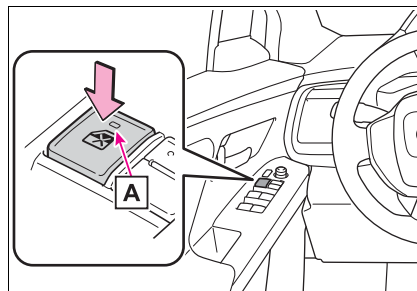

■ The window lock switch can be operated when

The power switch is in ON.

■ When the 12-volt battery is disconnected

The window lock switch is disabled. If necessary, press the window lock switch after reconnecting the 12-volt battery.

My Settings*

*: If equipped

By recognizing an individual through a device, such as an electronic key, and vehicle settings recorded for that driver can be recalled when the vehicle is entered. By assigning an authentication device to a driver in advance, the driver can enter the vehicle with their preferred settings. Settings for up to 3 drivers can be recorded by My Settings. For details on how to assign/delete electronic keys, set driver names, perform initialization, change drivers manually, or delete a driver, refer to the “MULTI-MEDIA OWNER’S MANUAL”.

Types of assigned authentication devices

An individual can be identified using the following authentication devices.

- Electronic key

An individual is identified when the Smart key system detects their electronic key.

- Bluetooth devices

An individual can be detected if the same Bluetooth device that was used as a handsfree phone the last

time the vehicle was entered is connected to the audio system.

Recalled functions

When an individual is identified from an authentication device, settings for the following functions are recalled.

- Meter displays and multimedia information*

When an individual is identified, the vehicle settings used when the power switch was last turned off are recalled.

- Vehicle settings that can be set using the multimedia display*

When an individual is identified, the vehicle settings used when the power switch was last turned off are recalled.

- Safe driving support function*

When an individual is identified, the vehicle settings used when the power switch was last turned off are recalled.

*: Some settings are excluded

| | |
|---|--|
| 5-1. Before driving | 5-4. Using the driving support systems |
| Driving the vehicle..... 219 | Software update 257 |
| Cargo and luggage 225 | Toyota Safety Sense 3.0 259 |
| Vehicle load limits 228 | PCS (Pre-Collision System) 265 |
| Trailer towing..... 229 | LTA (Lane Tracing Assist) 276 |
| Dinghy towing 230 | LDA (Lane Departure Alert) 281 |
| 5-2. Driving procedures | RSA (Road Sign Assist) 286 |
| Power (ignition) switch 231 | Dynamic radar cruise control 288 |
| Transmission 236 | Cruise control 296 |
| Turn signal lever..... 242 | Emergency Driving Stop System 299 |
| Parking brake 243 | BSM (Blind Spot Monitor) 302 |
| Brake Hold 246 | SEA (Safe Exit Assist) . 307 |
| 5-3. Operating the lights and wipers | Intuitive parking assist. 311 |
| Headlight switch 248 | RCTA (Rear Cross Traffic Alert)..... 322 |
| AHB (Automatic High Beam)..... 250 | RCD (Rear Camera Detection) 328 |
| Windshield wipers and washer..... 253 | PKSB (Parking Support Brake)..... 331 |
| | Static Objects Front and Rear of the Vehicle.... 336 |
| | Moving Vehicle Rear of the Vehicle..... 339 |

| | |
|--|-----|
| Pedestrians Rear of the Vehicle..... | 340 |
| Static Objects Around the Vehicle (vehicles with Advanced Park)..... | 342 |
| Toyota Teammate Advanced Park..... | 344 |
| Snow mode | 382 |
| X-MODE..... | 382 |
| Driving assist systems | 387 |
| 5-5. Driving tips | |
| Winter driving tips | 393 |
| Utility vehicle precautions | 396 |

Driving the vehicle

The following procedures should be observed to ensure safe driving:

Driving procedure

■ Before starting the EV system

Check that the charging cable is disconnected. (→P.105, 113)

■ Starting the EV system

→P.231

■ Driving

- 1 With the brake pedal depressed, shift the shift position to D. (→P.237)

Check that the shift position indicator shows D.

- 2 If the parking brake is set, release the parking brake. (→P.243)

If the parking brake is in automatic mode, the parking brake will be released automatically. (→P.243)

- 3 Gradually release the brake pedal and gently depress the accelerator pedal to accelerate the vehicle.

■ Stopping

- 1 Depress the brake pedal.
- 2 If necessary, set the parking brake. (→P.243)

If the vehicle is to be stopped for an extended period of time, shift the shift position to P. (→P.237)

■ Parking the vehicle

- 1 Depress the brake pedal to stop the vehicle completely.
- 2 If the parking brake is released, set the parking brake. (→P.243)

Make sure the parking brake indicator light is on.

- 3 Shift the shift position to P. (→P.237)

Check that the shift position indicator shows P and the parking brake indicator is illuminated.

- 4 Press the power switch to stop the EV system.

- 5 Slowly release the brake pedal.

- 6 Lock the door, making sure that you have the electronic key on your person.

If parking on a hill, block the wheels as needed.

■ Starting off on a steep uphill

- 1 Firmly depress the brake pedal and shift the shift position to D.

The hill-start assist control will be activated.

- 2 Set the parking brake. (→P.243)
- 3 Release the brake pedal and gently depress the accelerator pedal to accelerate the vehicle.
- 4 Release the parking brake. (→P.243)

■ **When starting off on a uphill**

The hill-start assist control will activate. (→P.387)

■ **Driving in the rain**

- Drive carefully when it is raining, because visibility will be reduced, the windows may become fogged-up, and the road will be slippery.
- Drive carefully when it starts to rain, because the road surface will be especially slippery.
- Refrain from high speeds when driving on an expressway in the rain, because there may be a layer of water between the tires and the road surface, preventing the steering and brakes from operating properly.

■ **Restraining the EV system output (Brake Override System)**

- When the accelerator and brake pedals are depressed at the same time, the EV system output may be restrained.
- A warning message is displayed on the multi-information display while the system is operating.

■ **Breaking in your new Toyota**

To extend the life of the vehicle, observing the following precautions is recommended:

- For the first 200 miles (300 km):
Avoid sudden stops.
- For the first 600 miles (1000 km):
 - Do not drive at extremely high speeds.
 - Avoid sudden acceleration.
 - Do not drive at a constant speed for extended periods.

 **WARNING**

Observe the following precautions. Failure to do so may result in death or serious injury.

■ **When starting the vehicle**

Always keep your foot on the brake pedal while stopped with the “READY” indicator is illuminated. This prevents the vehicle from creeping.

■ **When driving the vehicle**

- Do not drive if you are unfamiliar with the location of the brake and accelerator pedals to avoid depressing the wrong pedal.
 - Accidentally depressing the accelerator pedal instead of the brake pedal will result in sudden acceleration that may lead to an accident.
 - When backing up, you may twist your body around, leading to a difficulty in operating the pedals. Make sure to operate the pedals properly.
 - Make sure to keep a correct driving posture even when moving the vehicle only slightly. This allows you to depress the brake and accelerator pedals properly.
 - Depress the brake pedal using your right foot. Depressing the brake pedal using your left foot may delay response in an emergency, resulting in an accident.
- The driver should pay extra attention to pedestrians. As there is no engine noise, the pedestrians may misjudge the vehicle’s movement. Even though the vehicle is equipped with the Acoustic Vehicle Alerting System, drive with care as pedestrians in the vicinity may still not notice the vehicle if the surrounding area is noisy.

⚠ WARNING

- During normal driving, do not turn off the EV system. Turning the EV system off while driving will not cause loss of steering or braking control, however, power assist to the steering will be lost. This will make it more difficult to steer smoothly, so you should pull over and stop the vehicle as soon as it is safe to do so. In the event of an emergency, such as if it becomes impossible to stop the vehicle in the normal way: →P.505
- Use regenerative braking to maintain a safe speed when driving down a steep hill. Using the brakes continuously may cause the brakes to overheat and lose effectiveness. (→P.240)
- If “Regenerative braking limited. Press brake to decelerate.” appears on the multi-information display, firmly depress the brake pedal to decelerate the vehicle. (→P.522)
- Do not adjust the position of the steering wheel, the seat, or the inside or outside rear view mirrors while driving. Doing so may result in a loss of vehicle control.
- Always check that all passengers’ arms, heads or other parts of their body are not outside the vehicle.
- AWD models: Do not drive the vehicle off-road. This is not a AWD vehicle designed for off-road driving. Proceed with all due caution if it becomes unavoidable to drive off-road.

- Do not drive across a river or through other bodies of water. This may cause electric/electronic components to short circuit, damage the EV system or cause other serious damage to the vehicle.
 - Do not drive in excess of the speed limit. Even if the legal speed limit permits it, do not drive over 85 mph (140 km/h) unless your vehicle has high-speed capability tires. Driving over 85 mph (140 km/h) may result in tire failure, loss of control and possible injury. Be sure to consult a tire dealer to determine whether the tires on your vehicle are high-speed capability tires or not before driving at such speeds.
- When driving on slippery road surfaces**
- Sudden braking, acceleration and steering may cause tire slippage and reduce your ability to control the vehicle.
 - Sudden acceleration or regenerative braking due to shift changing could cause the vehicle to skid, resulting in an accident.
 - After driving through a puddle, lightly depress the brake pedal to make sure that the brakes are functioning properly. Wet brake pads may prevent the brakes from functioning properly. If the brakes on only one side are wet and not functioning properly, steering control may be affected.

**WARNING****■ When shifting the shift position**

- Do not let the vehicle roll backward while a forward driving position is selected, or roll forward while the shift position is in R. Doing so may result in an accident or damage to the vehicle.
- Do not shift the shift position to P while the vehicle is moving. Doing so can damage the transmission and may result in a loss of vehicle control.
- Do not shift the shift position to R while the vehicle is moving forward. Doing so can damage the transmission and may result in a loss of vehicle control.
- Do not shift the shift position to a driving position while the vehicle is moving backward. Doing so can damage the transmission and may result in a loss of vehicle control.
- Changing the shift position to N while the vehicle is moving will disengage the hybrid system. Regenerative braking is not available with the EV system disengaged.
- Be careful not to change the shift position with the accelerator pedal depressed. Changing the shift position to any positions other than P or N may lead to unexpected rapid acceleration of the vehicle that may cause an accident and result in death or serious injury. After changing the shift position, make sure to confirm the current shift position displayed on the shift position indicator inside the meter.

■ If you hear a squealing or scraping noise (brake pad wear limit indicators)

Have the brake pads checked and replaced by your Toyota dealer as soon as possible.

Rotor damage may result if the pads are not replaced when needed.

It is dangerous to drive the vehicle when the wear limits of the brake pads and/or those of the brake discs are exceeded.

■ When the vehicle is stopped

- Do not depress the accelerator pedal unnecessarily. If the shift position is in any position other than P or N, the vehicle may accelerate suddenly and unexpectedly, causing an accident.
- In order to prevent accidents due to the vehicle rolling away, always keep depressing the brake pedal while stopped with the "READY" indicator is illuminated, and apply the parking brake as necessary.
- If the vehicle is stopped on an incline, in order to prevent accidents caused by the vehicle rolling forward or backward, always depress the brake pedal and securely apply the parking brake as needed.

■ When the vehicle is parked

- Do not leave glasses, cigarette lighters, spray cans, or soft drink cans in the vehicle when it is in the sun. Doing so may result in the following:
 - Gas may leak from a cigarette lighter or spray can, and may lead to a fire.

⚠ WARNING

- The temperature inside the vehicle may cause the plastic lenses and plastic material of glasses to deform or crack.
- Soft drink cans may fracture, causing the contents to spray over the interior of the vehicle, and may also cause a short circuit in the vehicle's electrical components.
- Do not leave cigarette lighters in the vehicle. If a cigarette lighter is in a place such as the glove box or on the floor, it may be lit accidentally when luggage is loaded or the seat is adjusted, causing a fire.
- Do not attach adhesive discs to the windshield or windows. Do not place containers such as air fresheners on the instrument panel or dashboard. Adhesive discs or containers may act as lenses, causing a fire in the vehicle.
- Do not leave a door or window open if the curved glass is coated with a metallized film such as a silver-colored one. Reflected sunlight may cause the glass to act as a lens, causing a fire.
- Always apply the parking brake, shift the shift position to P, stop the EV system and lock the vehicle.
Do not leave the vehicle unattended while the "READY" indicator is illuminated.
If the vehicle is parked with the shift position in P but the parking brake is not set, the vehicle may start to move, possibly leading to an accident.

■ When taking a nap in the vehicle

Always turn the EV system off. Otherwise, you may accidentally move the shift lever or depress the accelerator pedal, causing the vehicle to unintentionally move, which can lead to an accident, resulting in death or serious injury.

■ When braking

- When the brakes are wet, drive more cautiously. Braking distance increases when the brakes are wet, and this may cause one side of the vehicle to brake differently than the other side. Also, the parking brake may not securely hold the vehicle.
- If the electronically controlled brake system does not operate, do not follow other vehicles closely and avoid hills or sharp turns that require braking. In this case, braking is still possible, but the brake pedal should be depressed more firmly than usual. Also, the braking distance will increase. Have your brakes fixed immediately.
- The brake system consists of 2 or more individual hydraulic systems; if one of the systems fails, the other(s) will still operate. In this case, the brake pedal should be depressed more firmly than usual and the braking distance will increase. Have your brakes fixed immediately.

■ If the vehicle becomes stuck (AWD models)

Do not spin the wheels excessively when any of the tires is up in the air, or the vehicle is stuck in sand, mud, etc. This may damage the driveline components or propel the vehicle forward or backward, causing an accident.



NOTICE

■ **When driving the vehicle**

- Do not depress the accelerator and brake pedals at the same time during driving, as this may restrain the EV system output.
- Do not use the accelerator pedal or depress the accelerator and brake pedals at the same time to hold the vehicle on a hill.

■ **Avoiding damage to vehicle parts**

- Do not turn the steering wheel fully in either direction and hold it there for an extended period of time.
Doing so may damage the power steering motor.
- When driving over bumps in the road, drive as slowly as possible to avoid damaging the wheels, underside of the vehicle, etc.

■ **If you get a flat tire while driving**

A flat or damaged tire may cause the following situations. Hold the steering wheel firmly and gradually depress the brake pedal to slow down the vehicle.

- It may be difficult to control your vehicle.
- The vehicle will make abnormal sounds or vibrations.
- The vehicle will lean abnormally.

Information on what to do in case of a flat tire (→P.527)

■ **When encountering flooded roads**

Do not drive on a road that has flooded after heavy rain, etc. Doing so may cause the following serious damage to the vehicle:

- Short in electrical components
- Traction battery caused by water immersion

In the event that you drive on a flooded road and the vehicle is flooded, be sure to have your Toyota dealer check the following:

- Brake function
- Changes in quantity and quality of transmission fluid, etc.
- Lubricant condition for the bearings and suspension joints (where possible), and the function of all joints, bearings, etc.
- Components connected to the traction battery.

If the shift control system is damaged by flooding, it may not be possible to shift the shift position to P, or from P to other positions. In this case, contact your Toyota dealer.

■ **When parking the vehicle**

Always set the parking brake, and shift the shift position to P. Failure to do so may cause the vehicle to move or the vehicle may accelerate suddenly if the accelerator pedal is accidentally depressed.

■ **When involved in a minor accident**

Damage to the traction battery or battery peripheral components could cause malfunctions. Even if it is a minor accident, have the vehicle inspected by your Toyota dealer.

Sudden start restraint control (Drive-Start Control [DSC])

When the following unusual

operation is performed with the accelerator pedal depressed, the EV system output may be restrained.

- When the shift position is shifted to R*.
- When the shift position is shifted from P or R to forward drive shift position such as D*.

When the system operates, a message appears on the multi-information display. Read the message and follow the instruction.

*: Depending on the situation, the shift position may not be changed.

■ Drive-Start Control (DSC)

- When the TRAC is turned off (→P.388), sudden start restraint control also does not operate. If your vehicle have trouble escaping from the mud or fresh snow due to sudden start restraint control operation, deactivate TRAC (→P.388) so that the vehicle may become able to escape from the mud or fresh snow.

Also, sudden start restraint control will not operate in the following conditions:

- When "X-MODE" is selected (if equipped)

Cargo and luggage

Take notice of the following information about storage precautions, cargo capacity and load.

WARNING

■ Things that must not be carried in the luggage compartment

The following things may cause a fire if loaded in the luggage compartment:

- Receptacles containing gasoline
- Aerosol cans

■ Storage precautions

Observe the following precautions.

Failure to do so may prevent the pedals from being depressed properly, may block the driver's vision, or may result in items hitting the driver or passengers, possibly causing an accident.

- Stow cargo and luggage in the luggage compartment whenever possible.
- Do not stack cargo and luggage in the luggage compartment higher than the seatbacks.
- Do not place cargo or luggage in or on the following locations.
 - At the feet of the driver
 - On the front passenger or rear seats (when stacking items)
 - On the luggage cover (if equipped)
 - On the instrument panel
 - On the dashboard

⚠ WARNING

- In front of the instrument cluster
- Secure all items in the occupant compartment.
- When you fold down the rear seats, long items should not be placed directly behind the front seats.
- Never allow anyone to ride in the luggage compartment. It is not designed for passengers. They should ride in their seats with their seat belts properly fastened.

Capacity and distribution

Cargo capacity depends on the total weight of the occupants.

(Cargo capacity) = (Total load capacity) - (Total weight of occupants)

Steps for Determining Correct Load Limit —

- (1) Locate the statement “The combined weight of occupants and cargo should never exceed XXX kg or XXX lbs.” on your vehicle’s placard.
- (2) Determine the combined weight of the driver and passengers that will be riding in your vehicle.
- (3) Subtract the combined weight of the driver and passengers from XXX kg or XXX lbs.
- (4) The resulting figure equals the available amount of cargo and luggage load capacity.

For example, if the “XXX” amount equals 1400 lbs. and there will be five 150 lb passengers in your vehicle, the amount of available cargo and luggage load capacity is 650 lbs. (1400 - 750 (5 × 150) = 650 lbs.)

(5) Determine the combined weight of luggage and cargo being loaded on the vehicle. That weight may not safely exceed the available cargo and luggage load capacity calculated in Step 4.

(6) If your vehicle will be towing a trailer, load from your trailer will be transferred to your vehicle. Consult this manual to determine how this reduces the available cargo and luggage load capacity of your vehicle. (→P.228)

⚠ WARNING

■ **Capacity and distribution**

- Do not exceed the maximum axle weight rating or the total vehicle weight rating.
- Even if the total load of occupant weight and the cargo load is less than the total load capacity, do not apply the load unevenly. Improper loading may cause deterioration of steering or braking control which may cause death or serious injury.

Calculation formula for your vehicle

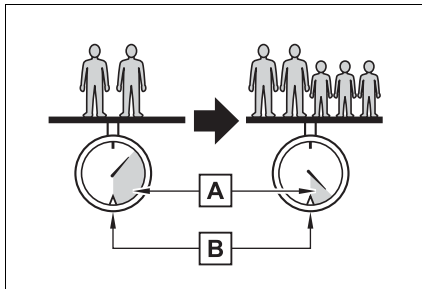

- A** Cargo capacity
- B** Total load capacity (vehicle capacity weight) (→P.550)

When 2 people with the combined weight of A lb. (kg) are riding in your vehicle, which has a total load capacity (vehicle capacity weight) of B lb. (kg), the available amount of cargo and luggage load capacity will be C lb. (kg) as follows:

$$B^*2 \text{ lb. (kg)} - A^*1 \text{ lb. (kg)} = C^*3 \text{ lb. (kg)}$$

*1: A = Weight of people

*2: B = Total load capacity

*3: C = Available cargo and luggage load

In this condition, if 3 more passengers with the combined weight of D lb. (kg) get on, the available cargo and luggage load will be reduced E lb. (kg) as follows:

$$C \text{ lb. (kg)} - D^*4 \text{ lb. (kg)} = E^*5 \text{ lb. (kg)}$$

*4: D = Additional weight of people

*5: E = Available cargo and luggage

load

As shown in the example above, if the number of occupants increases, the cargo and luggage load will be reduced by an amount that equals the increased weight due to the additional occupants. In other words, if an increase in the number of occupants causes an excess of the total load capacity (combined weight of occupants plus cargo and luggage load), you must reduce the cargo and luggage on your vehicle.

WARNING

When loading cargo on the roof luggage carrier (if equipped)

Observe the following precautions:

- Place the cargo so that its weight is distributed evenly between the front and rear axles.
- If loading long or wide cargo, never exceed the vehicle overall length or width. (→P.550)
- Before driving, make sure the cargo is securely fastened on the roof luggage carrier.
- Loading cargo on the roof luggage carrier will make the center of gravity of the vehicle higher. Avoid high speeds, sudden starts, sharp turns, sudden braking or abrupt maneuvers, otherwise it may result in loss of control or vehicle rollover due to failure to operate this vehicle correctly and result in death or serious injury.

 **WARNING**

- If driving for a long distance, on rough roads, or at high speeds, stop the vehicle now and then during the trip to make sure the cargo remains in its place.
- Do not exceed 165.3 lb. (75 kg) cargo weight on the roof luggage carrier.

 **NOTICE**

- **When loading cargo on the roof luggage carrier (if equipped)**
Be careful not to scratch the surface of the panoramic moon roof (if equipped).

Vehicle load limits

Vehicle load limits include total load capacity, seating capacity, TWR (Trailer Weight Rating) and cargo capacity.

- Total load capacity (vehicle capacity weight): →P.550

Total load capacity means the combined weight of occupants, cargo and luggage.

- Seating capacity: →P.550

Seating capacity means the maximum number of occupants whose estimated average weight is 150 lb. (68 kg) per person.

- TWR (Trailer Weight Rating)

Toyota does not recommend towing a trailer with your vehicle.

- Cargo capacity

Cargo capacity may increase or decrease depending on the weight and the number of occupants.

■ **Total load capacity and seating capacity**

These details are also described on the tire and loading information label. (→P.491)

⚠ WARNING

■ Overloading the vehicle

Do not overload the vehicle. It may not only cause damage to the tires, but also degrade steering and braking ability, resulting in an accident.

Trailer towing

Toyota does not recommend towing a trailer with your vehicle. Toyota also does not recommend the installation of a tow hitch or the use of a tow hitch carrier for a wheelchair, scooter, bicycle, etc. Your vehicle is not designed for trailer towing or for the use of tow hitch mounted carriers.



Dinghy towing

Your vehicle is not designed to be dinghy towed (with 4 wheels on the ground) behind a motor home.

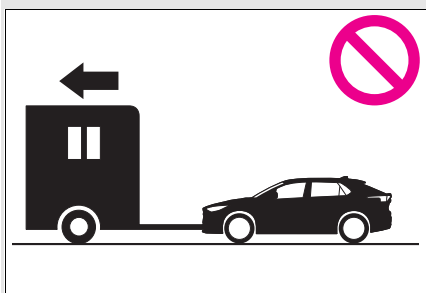

NOTICE

■ **To avoid serious damage to your vehicle**

Do not tow your vehicle with 4 wheels on the ground.

Power (ignition) switch

Performing the following operations when carrying the electronic key on your person starts the EV system or changes power switch modes.

Starting the EV system

- 1 Check that the charging cable is disconnected. (→P.105, 113)
- 2 Pull the parking brake switch to check that the parking brake is set. (→P.243)

The parking brake indicator will come on.

- 3 Firmly depress the brake pedal.

 and a message will be displayed on the multi-information display.

If it is not displayed, the EV system cannot be started.

When the shift position is in N, the EV system cannot start. Shift the shift position to P when starting the EV system. (→P.237)

- 4 Press the power switch shortly and firmly.

When operating the power switch, one short, firm press is enough. It is not necessary to press and hold the switch.

If the “READY” indicator turns on, the EV system will operate normally.

Continue depressing the brake pedal until the “READY” indicator is

illuminated.

The EV system can be started from any power switch mode.

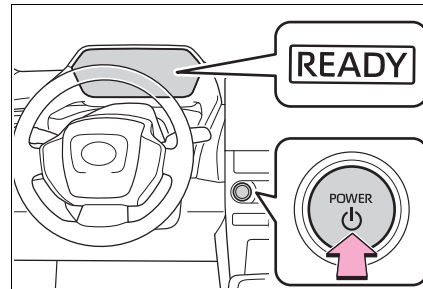

- 5 Check that the “READY” indicator is illuminated.

The vehicle cannot be driven if the “READY” indicator is off.

■ Power switch illumination

According to the situation, the power switch illumination operates as follows.

- When driver’s door or front passenger’s door is opened, the power switch illumination illuminates.
- When the power switch is in OFF and depressing the brake pedal with carrying the electronic key on your person, the power switch illumination blinks.
- When the power switch is in ACC or ON, the power switch illumination illuminates.
- When the power switch mode is changed from ACC or ON to OFF, the power switch illumination illuminates for a certain amount of time. Afterwards, the power switch illumination turns off.

■ If the EV system does not start

- The immobilizer system may not have been deactivated. (→P.68) Contact your Toyota dealer.
- The charging cable may be connected to the vehicle. (→P.89)
- If a message related to start-up is

shown on the multi-information display, read the message and follow the instructions.

- If the door is unlocked with the mechanical key, the EV system cannot be started using the smart key system. Refer to P.540 to start the EV system. However, if the electronic key is carried inside the vehicle and the doors are locked (→P.170), the EV system can be started.

■ **When the ambient temperature is low, such as during winter driving conditions**

- When starting the EV system, the flashing time of the “READY” indicator may be long. Leave the vehicle as it is until the “READY” indicator is steady on, as steady means the vehicle is able to move.
- When the traction battery is extremely cold (below approximately -22°F [-30°C]) under the influence of the outside temperature, it may not be possible to start the EV system. In this case, try to start the EV system again after the temperature of the traction battery increases due to the outside temperature increase, etc.

■ **Sounds and vibrations specific to an battery electric vehicle**

→P.74

■ **If the 12-volt battery is discharged**

The EV system cannot be started using the smart key system. Refer to P.541 to restart the EV system.

■ **Electronic key battery depletion**

→P.162

■ **Conditions affecting operation**

→P.188

■ **Note for the entry function**

→P.189

■ **If there is a malfunction in the smart key system**

If “Smart Key System Malfunction” is displayed on the multi-information display, the system may be malfunctioning. Have the vehicle inspected by your Toyota dealer immediately.

■ **If the “READY” indicator does not come on**

In the event that the “READY” indicator does not come on even after performing the proper procedures for starting the vehicle, contact your Toyota dealer immediately.

■ **If the EV system is malfunctioning**

→P.80

■ **Electronic key battery**

→P.497

■ **Operation of the power switch**

- If the switch is not pressed shortly and firmly, the power switch mode may not change or the EV system may not start.
- If attempting to restart the EV system immediately after turning the power switch to OFF, the EV system may not start in some cases. After turning the power switch to OFF, please wait a few seconds before restarting the EV system.

■ **Customization**

If the smart key system has been deactivated in a customized setting, refer to P.540.

 **WARNING**

■ **When starting the EV system**

Always start the EV system while sitting in the driver's seat. Do not depress the accelerator pedal while starting the EV system under any circumstances. Doing so may cause an accident resulting in death or serious injury.

**NOTICE****■ When starting the EV system**

If the EV system becomes difficult to start, have your vehicle checked by your Toyota dealer immediately.

■ Symptoms indicating a malfunction with the power switch

If the power switch seems to be operating somewhat differently than usual, such as the switch sticking slightly, there may be a malfunction. Contact your Toyota dealer immediately.

Stopping the EV system

- 1 Stop the vehicle completely.
- 2 Set the parking brake.
(→P.243)
- 3 Press the P position switch.
(→P.237)

Check that the shift position indicator shows P and the parking brake indicator is illuminated.

- 4 Press the power switch.

The EV system will stop, and the meter display will be extinguished (the shift position indicator will be extinguished a few seconds after the meter display).

- 5 Release the brake pedal and check that "ACCESSORY" or "POWER ON" is not shown on the meter.

■ Automatic EV system shut off feature

- The vehicle is equipped with a feature that automatically shuts off the EV system when the shift position is in P with the EV system

operating for an extended period.

- The EV system will automatically shut off after approximately 1 hour if it has been left operating while the shift position is in P.
- The timer for the automatic EV system shut off feature will reset if the brake pedal is depressed or if the shift position is in a position other than P.
- After the vehicle is parked, if the door is locked with the door lock switch (→P.170) from the inside or the mechanical key (→P.539) from the outside, the automatic EV system shut off feature will be disabled. The timer for the automatic EV system shut off feature will be re-enabled if the driver's door is opened.

■ When the shift control system malfunctions

When attempting to turn the power switch off while there is a malfunction in the shift control system, the power switch mode may change to ACC. In this case, ACC may be turned off by applying the parking brake and pressing the power switch again.

If there is a malfunction in the system, have the vehicle inspected by your Toyota dealer immediately.

■ Automatic P position selection function

→P.238

⚠ WARNING**■ Stopping the EV system in an emergency**

- If you want to stop the EV system in an emergency while driving the vehicle, press and hold the power switch for more than 2 seconds, or press it briefly 3 times or more in succession. (→P.505)

However, do not touch the power switch while driving except in an emergency. Turning the EV system off while driving will not cause a loss of steering or braking control. However, power assist for the steering wheel may be lost making it difficult to steer smoothly before stopping the vehicle depending on the remaining charge in the 12-volt battery or usage conditions. In this situation, you should pull over and stop the vehicle as soon as it is safe to do so.

- If the power switch is operated while the vehicle is running, a warning message will be shown on the multi-information display and a buzzer sounds.
- When restarting the EV system after an emergency shutdown, press the power switch shortly and firmly.

■ When parking

Exhaust gases include harmful carbon monoxide (CO), which is colorless and odorless. Observe the following precautions.

Failure to do so may cause exhaust gases to enter the vehicle and may lead to an accident caused by light-headedness, or may lead to death or a serious health hazard.

- If the vehicle is in a poorly ventilated area or a closed area, such as a garage, stop the EV system.
- Do not leave the vehicle with the EV system operating for a long time. If such a situation cannot be avoided, park the vehicle in an open space and ensure that exhaust fumes do not enter the vehicle interior.
- Do not leave the EV system operating in an area with snow build-up, or where it is snowing. If snowbanks build up around the vehicle while the EV system is operating, exhaust gases may collect and enter the vehicle.

Changing power switch modes

Modes can be changed by pressing the power switch with the brake pedal released. (The mode changes each time the switch is pressed.)

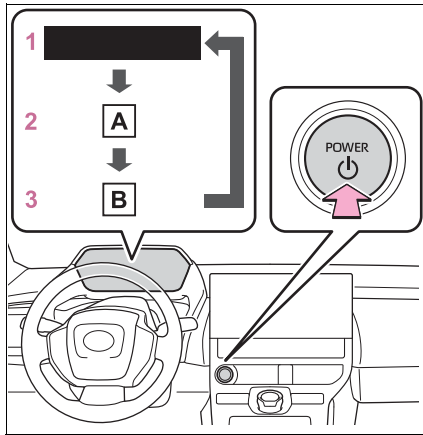

A "ACCESSORY"

B "POWER ON"

1 OFF

The emergency flashers can be used.

2 ACC*

Some electrical components such as the audio system can be used. "ACCESSORY" will be displayed on the multi-information display.

3 ON

All electrical components can be used.

"POWER ON" will be displayed on the multi-information display.

*: Setting can be customized.
(→P.571)

■ Auto power off function

If the vehicle is left in ACC for more than 20 minutes or ON (the EV system is not operating) for more than an hour with the shift position in P, the power switch will automatically turn off. However, this function cannot entirely prevent the 12-volt battery discharge. Do not leave the vehicle with the power switch in ACC or ON for long periods of time

when the EV system is not operating.

NOTICE

■ To prevent 12-volt battery discharge

- Do not leave the power switch in ACC or ON for long periods of time without the EV system on.
- If "ACCESSORY" or "POWER ON" is displayed on the multi-information display, the power switch is not in OFF. Exit the vehicle after turning the power switch to OFF.

Transmission

Select the shift position depending on your purpose and situation.

Shift position purpose and functions

| Shift position | Objective or function |
|----------------|--|
| P | Parking the vehicle/starting the EV system |
| R | Reversing |
| N | Neutral (Condition in which the power is not transmitted) |
| D | Normal driving |

■ **Restraining sudden start (Drive-Start Control)**

→P.224

■ **If a message about a shift operation is shown**

To prevent the shift position from being selected incorrectly or the vehicle from moving unexpectedly, the shift position may be changed automatically or operating the rotary shifter may be required. In this case, change the shift position following the messages on the multi-information display.

■ **After recharging/reconnecting the 12-volt battery**

→P.469

 **WARNING**

■ **When driving on slippery road surfaces**

Be careful of sudden acceleration, as this could result in the vehicle skidding to the side or spinning.

 **NOTICE**

■ **Situations where shift control system malfunctions are possible**

If any of the following situations occur, shift control system malfunctions are possible. Immediately stop the vehicle in a safe place on level ground, apply the parking brake, and then contact your Toyota dealer.

- When the warning message indicating the shift control system malfunction appears on the multi-information display. (→P.522)
- The display indicates that no shift position is selected for more than a few seconds.

Shift position display and how to change the shift position

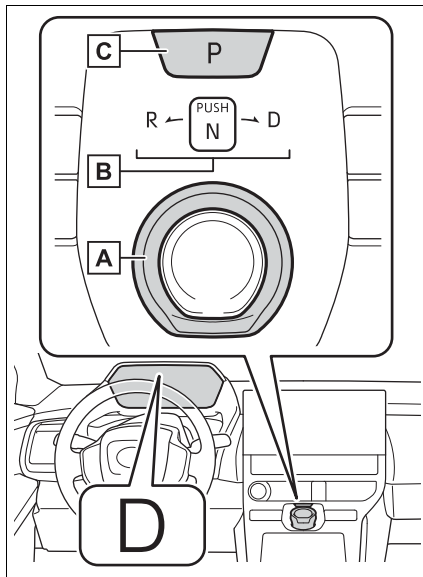

A Rotary shifter

Operate the dial shift slowly and securely.

To switch to N, hold down the dial shift and hold it for a while.

To switch to R or D, hold down the dial shift and turn left or right according to the arrow on the shift position indicator.

Release the rotary shifter after each shifting operation to allow it to return to its regular position.

When shifting from P to N, D or R, from N, D or R to P, from D to R, or from R to D, ensure that the brake pedal is being depressed and the vehicle is stationary.

B Shift position indicator

Meter display:

The current shift position is illumi-

nated.

Rotary shifter display:

The current shift position is illuminated.

When selecting the shift position, make sure that the shift position has been changed to the desired position by checking the shift position indicator provided on the instrument cluster.

C P position switch

Fully stop the vehicle and set the parking brake, and then press the P position switch.

When the shift position is changed to P, the switch illuminates.

Check that the shift position indicator shows P.

Changing the shift position in each power switch mode

- The shift position cannot be changed when the power switch is in ACC or off.
- When the power switch is in ON, if the "READY" indicator is not illuminated, the shift position can only be changed to N.
- When the "READY" indicator is illuminated, the shift position can be changed from P to D, N, or R.
- When the "READY" indicator is flashing, the shift position cannot be changed from P to any other position, even if the rotary shifter is operated. Operate the rotary shifter again after the "READY" indicator changes from flashing to illuminated.

Shifting the shift position from P to other positions

- While depressing the brake pedal firmly, operate the rotary shifter. If the rotary shifter is operated without depressing the brake pedal, the buzzer will sound and the

shifting operation will be disabled.

- When selecting the shift position, make sure that the shift position has been changed to the desired position by checking the shift position indicator provided on the instrument cluster.

■ The shift position cannot be changed when

In the following situations, a buzzer will sound to inform you that the shift position cannot be changed. Use the appropriate operation to attempt to change the shift position again.

- When attempting to change the shift position from P with the brake pedal not depressed
- When attempting to change the shift position from P with the accelerator pedal depressed
- When attempting to change the shift position from N while stopped or driving at an extremely low speed with the brake pedal not depressed
- When attempting to change the shift position from N while stopped or driving at an extremely low speed with the accelerator pedal depressed
- When the P position switch is pressed while driving

When driving at an extremely low speed, the shift position may change to P.

■ The shift position automatically changes to N when

In the following situations, a buzzer will sound to inform you that the shift position has been changed to N. Use the appropriate operation to attempt to change the shift position again.

- When attempting to change the shift position to R while the vehicle is moving forward

When driving at a low speed, the shift position may change to R.

- When attempting to change the shift position to D while the vehicle is moving backward

When driving at a low speed, the shift position may change to D.

■ When N is selected while driving

When selecting N while traveling at a speed above a certain level, hold the rotary shifter at the N position.

■ Automatic P position selection function

In the following situations, the shift position is automatically changed to P.

- When pressing the power switch with the vehicle stopped while the power switch is in ON and the shift position is in a position other than P (after the shift position has been changed to P, the power switch will turn off)*
- If the driver's door is opened and all of the following conditions are met, while the shift position is in a position other than P:
 - The power switch is in ON.
 - The driver is not wearing the seat belt.
 - The brake pedal is not depressed.

To start off the vehicle after the shift position is changed to P, operate the rotary shifter again.

- When the vehicle is stopped after the EV system has been stopped in an emergency while driving
- When voltage of the 12-volt battery drops while the shift position is in a position other than P

*: When the power switch is pressed while driving at extremely slow speeds, such as immediately before stopping the vehicle, the shift position may automatically change to P. Make sure that the vehicle is completely stopped before pressing the power switch.

■ **If the shift position cannot be shifted from P**

There is a possibility that the 12-volt battery is discharged. Check the 12-volt battery in this situation. (→P.541)

■ **Customization**

Some functions can be customized. (→P.572)

 **WARNING**

■ **For the rotary shifter**

● Do not remove the rotary shifter knob or use anything but a genuine Toyota rotary shifter knob. Also, do not hang anything on the rotary shifter. Doing so could prevent the rotary shifter from returning to position, causing unexpected accidents to occur when the vehicle is in motion.

● In order to prevent the shift position from accidentally being changed, do not touch the rotary shifter when not using it.

■ **P position switch**

● Do not press the P position switch while the vehicle is moving. If the P position switch is pressed when driving at very low speeds (for example, directly before stopping the vehicle), the vehicle may stop suddenly when the shift position switches to P, which could lead to an accident.

● In order to prevent the shift position from accidentally being changed, do not touch the P position switch when not using it.

 **NOTICE**

■ **When exiting the vehicle (driver's seat only)**

Check that the shift position indicator shows P and that the parking brake indicator is illuminated before opening the door and exiting the vehicle.

Keeping the shift position in N without activating the automatic P position selection function

● By performing the following operation, the shift position can be held in N until the shift position switches to P without activating the automatic P position selection function.

- 1 Operate the rotary shifter and change the shift position to N when the EV system is operating.
- 2 Return the rotary shifter to its regular position.
- 3 Operate the rotary shifter to N and hold it there until the buzzer sounds.
- 4 Press the power switch within 5 seconds after the buzzer sounds.

The EV system stops with the shift position in N*

Make sure to check that the buzzer sounds and "Holding N Push P Switch When Done" is displayed on the multi-information display.

- In order to shift to a position other than N, first press the P

position switch to change the shift position to P.

- If the automatic P position switching operation selection function is performed operated with the EV system stopped, the automatic P position selection function may not operate.

Always perform the operation with the EV system started.

- *: To keep this state, do not operate the power switch. If the power switch is operated repeatedly, the power switch will turn off after the shift position has automatically changed to P.

Selecting the driving mode

■ "X-MODE"

→P.382

Regeneration Boost switch

Acceleration/deceleration control can be performed only by operating the accelerator pedal, and the frequency of switching to the brake pedal can be greatly reduced. Since the deceleration when the accelerator pedal is released is stronger than that of a conventional vehicle, the vehicle can be decelerated smoothly by slowly releasing the pedal the accelerator pedal without completely

releasing it.

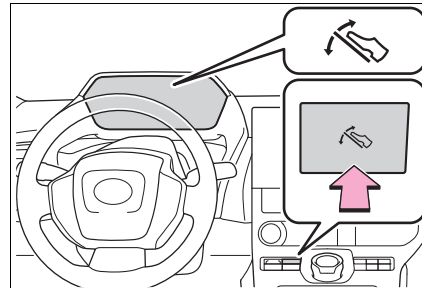

When the Regeneration Boost switch is pressed, the regenerative braking force, when the accelerator pedal is released, becomes stronger than usual.

■ When Regeneration Boost cannot be used in the following cases, the system does not operate.

- When "X-MODE" is activated (If equipped)
- When the brake system or EV system is malfunctioning
- When regenerative braking is limited

Regenerative braking may be restricted in the following situations:

- When the amount of charge of the traction battery is high
- When the temperature of the traction battery is low or extremely high
- When the temperature of the electric motor or power control unit is extremely high
- When regenerative braking is continually used for a long time

■ Regenerative Braking

- The vehicle cannot be stopped by just releasing the accelerator pedal. Step on the brake pedal when the vehicle is stopped.
- If the power switch is turned off and then the EV system is

restarted, the Regeneration Boost will be turned off.

- When driving at high speeds, the feeling of deceleration due to regenerative braking is smaller than in a normal car.
- The maximum deceleration varies depending on the vehicle speed.
- Regeneration Boost cannot be used when the following message is displayed on the multi-information display.
 - When decelerating, firmly step on the brake to decelerate.
 - “Regeneration Boost Unavailable XMODE Activated”
 - “Regeneration Boost Temporarily Unavailable Press Brake to Decelerate.”
 - “Regeneration Boost Temporarily Unavailable See Owner’s Manual”

■ Stop lights turning ON

When the regenerative braking force exceeds a certain level, the stop lights turn on.

Selecting Eco mode

It is suited for driving that suppresses vehicle driving power and improves power consumption.

Press the switch to switch over to Eco mode.

Press the switch again to return to Normal driving mode.

The Eco mode ON state is memorized even if the power switch is turned OFF.

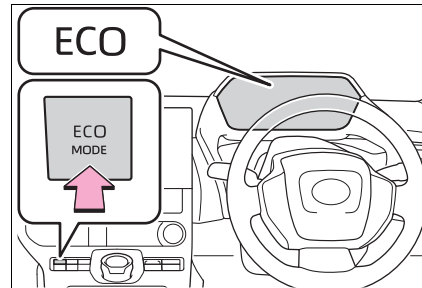

■ Eco mode drive automatic cancellation

Eco mode is automatically canceled when snow mode or “X-MODE” is selected and the vehicle returns to normal mode. (If equipped)

■ When Eco mode is not available

Eco mode cannot be activated when “X-MODE” is selected. (If equipped)

Turn signal lever

Operating instructions

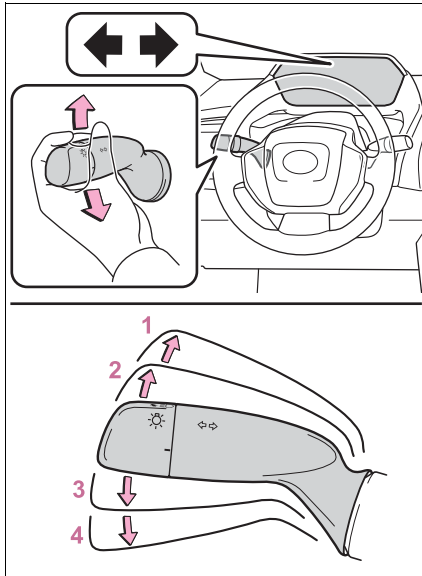

- 1 Right turn
- 2 Lane change to the right
(move the lever partway and release it)
The right hand signals will flash 3 times.
- 3 Lane change to the left
(move the lever partway and release it)
The left hand signals will flash 3 times.
- 4 Left turn

■ **Turn signals can be operated when**

The power switch is in ON.

■ **If the indicator flashes faster than usual**

Check that a light bulb in the front or rear turn signal lights has not

burned out.

■ **If the turn signals stop flashing before a lane change has been performed**

Operate the lever again.

Parking brake

The parking brake can be set or released automatically or manually.

In automatic mode, the parking brake can be set or released automatically. Also, even in automatic mode, the parking brake can be set or released manually.

Operating instructions

■ **Using the manual mode**

The parking brake can be set and released manually.

and a message is shown on the multi-information display.

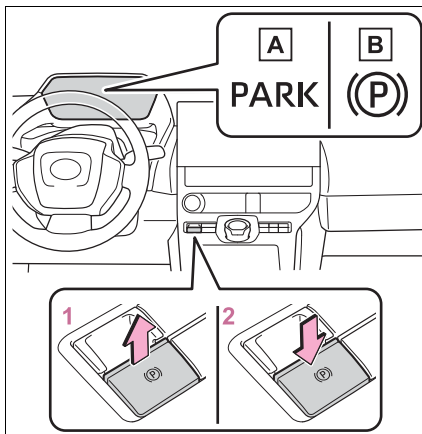

A Parking brake indicator light (U.S.A.)

B Parking brake indicator light (Canada)

1 Pull the switch to set the parking brake

The parking brake indicator light will turn on.

Pull and hold the parking brake switch if an emergency occurs and it is necessary to operate the parking brake while driving.

2 Push the switch to release the parking brake

- Operate the parking brake switch while depressing the brake pedal.
- Using the parking brake automatic release function, the parking brake can be released by depressing the accelerator pedal. (→P.244)

Make sure that the parking brake indicator light turn off.

If the parking brake indicator light flash, operate the switch again. (→P.518)

■ **Turning the automatic mode on**

While the vehicle is stopped, pull and hold the parking brake switch until a buzzer sounds and a message is shown on the multi-information display.

When the automatic mode is turned on, the parking brake operates as follows.

- When the shift position is shifted from P, the parking brake will be released, and the parking brake indicator light will turn off.
- When the shift position is shifted to P, the parking brake will be set, and the parking brake indicator light will turn on.

Operate the shift position with the vehicle stopped and the brake pedal depressed.

The auto function may not operate if the shift position is moved extremely quickly. In this situation, apply the parking brake manually. (→P.243)

■ Turning the automatic mode off

While the vehicle is stopped and depressing the brake pedal, press and hold the parking brake switch until a buzzer sounds and message is shown on the multi-information display.

■ Parking brake operation

- When the power switch is not in ON, the parking brake cannot be released using the parking brake switch.
- When the power switch is not in ON, automatic mode (automatic brake setting and releasing) is not available.

■ Parking brake automatic release function

When all of the following conditions are met in manual mode, the parking brake can be released by depressing the accelerator pedal.

- The driver's door is closed
- The driver is wearing the seat belt
- The shift position is in a forward driving position or reverse driving position
- The malfunction indicator lamp or brake system warning light is not illuminated.

When depressing the accelerator pedal, depress it slowly.

If the parking brake is not released

when the accelerator pedal is depressed, release the parking brake manually.

■ Parking brake automatic lock function

The parking brake will be set automatically under the following conditions:

- The brake pedal is not depressed
- The driver's door is open
- The driver's seat belt is not fastened
- The shift position is in a position other than P or N (The shift position is in P during advanced park operation.)(If equipped)
- The malfunction indicator lamp or brake system warning light are not illuminated.

■ If "Parking Brake Temporarily Unavailable" is displayed on the multi-information display

If the parking brake is operated repeatedly over a short period of time, the system may restrict operation to prevent overheating. If this happens, refrain from operating the parking brake. Normal operation will return after about 1 minute.

■ If "Parking Brake Unavailable" is displayed on the multi-information display

Operate the parking brake switch. If the message does not disappear after operating the switch several times, the system may be malfunctioning. Have the vehicle inspected by your Toyota dealer.

■ Parking brake operation sound

When the parking brake operates, a motor sound (whirring sound) may be heard.

This does not indicate a malfunction.

■ Parking brake indicator light

- Depending on the power switch

mode, the parking brake indicator light will turn on and stay on as described below:
 ON: Comes on until the parking brake is released.
 Not in ON: Stays on for approximately 15 seconds.

- When the power switch is turned off with the parking brake set, the parking brake indicator light will stay on for about 15 seconds. This does not indicate a malfunction.

■ **When the parking brake switch malfunctions**

Automatic mode (automatic brake setting and releasing) will be turned on automatically.

■ **Parking the vehicle**

→P.243

■ **Parking brake engaged warning buzzer**

A buzzer will sound if the vehicle is driven with the parking brake engaged. "Parking Brake ON" is displayed on the multi-information display. (with the vehicle reached a speed of 3 mph [5 km/h])

■ **If the brake system warning light comes on**

→P.513

■ **Usage in winter time**

→P.394

 **WARNING**

■ **When parking the vehicle**

Do not leave a child in the vehicle alone. The parking brake may be released unintentionally and there is the danger of the vehicle moving that may lead to an accident resulting in death or serious injury.

■ **Parking brake switch**

Do not set any objects near the parking brake switch. Objects may interfere with the switch and may lead the parking brake to unexpectedly operate.

■ **Parking brake automatic lock function**

Never use the automatic parking brake engagement function in place of normal parking brake operation. This function is designed to reduce the risk of a collision due to the driver forgetting to engage the parking brake. Over-reliance on this function to park the vehicle safely may lead to an accident resulting in death or serious injury. (→P.219)

 **NOTICE**

■ **When parking the vehicle**

Before you leave the vehicle, shift the shift position to P, set the parking brake and make sure that the vehicle does not move.

■ **When the system malfunctions**

Stop the vehicle in a safe place and check the warning messages.

■ **When the vehicle 12-volt battery is discharged**

The parking brake system cannot be activated. (→P.541)

■ **When the parking brake cannot be released due to a malfunction**

Driving the vehicle with the parking brake set will lead to brake components overheating, which may affect braking performance and increase brake wear.

Have the vehicle inspected by your Toyota dealer immediately if this occurs.

Brake Hold

The brake hold system keeps the brake applied when the shift position is in D or N with the system on and the brake pedal has been depressed to stop the vehicle. The system releases the brake when the accelerator pedal is depressed with the shift position in D to allow smooth start off.

Enabling the system

Turns the brake hold system on

The brake hold standby indicator (green) **A** comes on. While the system is holding the brake, the brake hold operated indicator (yellow) **B** comes on.

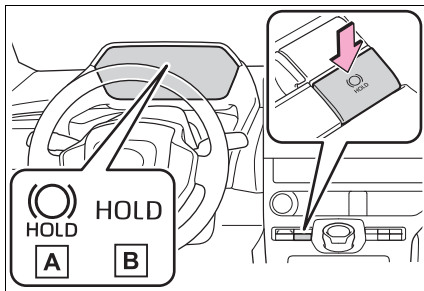

Brake hold system operating conditions

The brake hold system cannot be turned on in the following conditions:

- The driver's door is not closed.
- The driver is not wearing the seat

belt.

- "Parking Brake Unavailable" or "Parking Brake Malfunction Visit Your Dealer" is displayed on the multi-information display.

If any of the conditions above are detected when the brake hold system is enabled, the system will turn off and the brake hold standby indicator light will go off. In addition, if any of the conditions are detected while the system is holding the brake, a warning buzzer will sound and a message will be shown on the multi-information display. The parking brake will then be set automatically.

Brake hold function

- If the brake pedal is left released for a period of about 3 minutes after the system has started holding the brake, the parking brake will be set automatically. In this case, a warning buzzer sounds and a message is shown on the multi-information display.
- The brake hold function may not hold the vehicle when the vehicle is on a steep incline. In this situation, it may be necessary for the driver to apply the brakes. A warning buzzer will sound and the multi-information display will inform the driver of this situation. If a warning message is shown on the multi-information display, read the message and follow the instructions.
- To turn the system off while the system is holding the brake, firmly depress the brake pedal and press the button again.

When the parking brake is set automatically while the system is holding the brakes

Perform any of the following operations to release the parking brake:

- Depress the accelerator pedal. (The parking brake will not be released automatically if the seat

belt is not fastened.)

- Operate the parking brake switch with the brake pedal depressed.

Make sure that the parking brake indicator light goes off. (→P.243)

■ When an inspection at your Toyota dealer is necessary

When the brake hold standby indicator (green) does not illuminate even when the brake hold switch is pressed with the brake hold system operating conditions met, the system may be malfunctioning. Have the vehicle inspected at your Toyota dealer.

■ If “Brake Hold Malfunction Press Brake to Deactivate Visit Your Dealer” or “Brake Hold Malfunction Visit Your Dealer” is displayed on the multi-information display

The system may be malfunctioning. Have the vehicle inspected by your Toyota dealer.

■ Warning messages and buzzers

Warning messages and buzzers are used to indicate a system malfunction or to inform the driver of the need for caution. If a warning message is shown on the multi-information display, read the message and follow the instructions.

■ If the brake hold operated indicator flashes

→P.519



WARNING

■ When the vehicle is on a steep incline

When using the brake hold system on a steep incline, exercise caution. The brake hold function may not hold the vehicle in such a situation.

■ When stopped on a slippery road

The system cannot stop the vehicle when the gripping ability of the tires has been exceeded. Do not use the system when stopped on a slippery road.



NOTICE

■ When parking the vehicle

The brake hold system is not designed for use when parking the vehicle for a long period of time. Turning the power switch off while the system is holding the brake may release the brake, which would cause the vehicle to move. When operating the power switch, depress the brake pedal, shift the shift position to P and set the parking brake.

Headlight switch

The headlights can be operated manually or automatically.

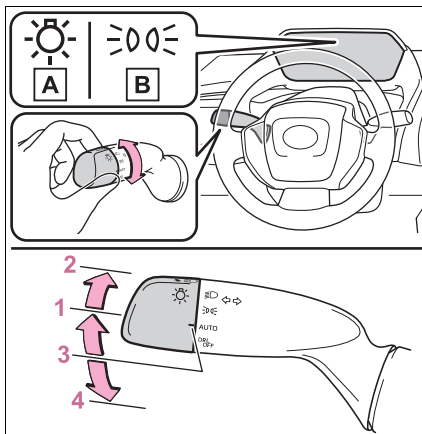

Turning on the headlights

Operating the  switch turns on the lights as follows:



A U.S.A.

B Canada



- 1  The side marker, parking, tail, license plate, instrument panel lights, daytime running lights (→P.248) turn on.
- 2  The headlights and all lights listed above (except daytime running lights) turn on.
- 3  The headlights, daytime running lights (→P.248) and

all the lights listed above turn on and off automatically.

- 4  Off (for the U.S.A. only)

■ **AUTO mode can be used when**
The power switch is in ON.

■ Daytime running light system

- The daytime running lights illuminate using the same lights as the parking lights and illuminate but at a higher intensity. (On some models: Using the same lights as the headlights but at a lower intensity.)
 - To make your vehicle more visible to other drivers during daytime driving, the daytime running lights turn on automatically when all of the following conditions are met. (The daytime running lights are not designed for use at night.)
 - The EV system is operating
 - The parking brake is released
 - The headlight switch is in the  or  position
 - The surroundings are bright
- The daytime running lights remain on after they illuminate, even if the parking brake is set again.

- For the U.S.A.: Daytime running lights can be turned off by operating the switch.
- Compared to turning on the headlights, the daytime running light system offers greater durability and consumes less electricity, so it can help improve electricity consumption.

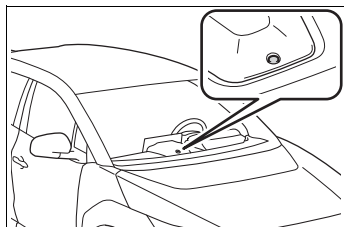

■ Headlight control sensor

The sensor may not function properly if an object is placed on the sensor, or anything that blocks the sensor is affixed to the windshield. Doing so interferes with the sensor detecting the level of ambient light and may cause the automatic headlight system to malfunction.



■ **Automatic light off system**

- When the headlights are on: The lights turn off 30 seconds after the power switch is turned to ACC or OFF and a door is opened and closed. (The lights turn off immediately if  on the key is pressed after all the doors are closed.)
- When only the tail lights are on: The tail lights turn off automatically if the power switch is turned to ACC or OFF and the driver's door is opened.

To turn the lights on again, turn the power switch to ON, or turn the light switch to the **AUTO** or **DRL OFF** position once and then back to  or  position.

■ **Light reminder buzzer**

A buzzer sounds when the power switch is turned to ACC or OFF and the driver's door is opened while the lights are turned on.

■ **Automatic headlight leveling system**

The level of the headlights is automatically adjusted according to the number of passengers and the loading condition of the vehicle to ensure that the headlights do not interfere with other road users.

■ **Windshield wiper linked headlight illumination**

When driving during daytime with the headlight switch turned to **AUTO**, if

the windshield wipers are used, the headlights will turn on automatically after several seconds to help enhance the visibility of your vehicle.

■ **12-volt battery-saving function**

In order to prevent the 12-volt battery of the vehicle from discharging, if the headlights and/or tail lights are on when the power switch is turned to OFF, the battery saving function will operate and automatically turn off all the lights after approximately 20 minutes.

When any of the following are performed, the 12-volt battery-saving function is canceled once and then reactivated. All the lights will turn off automatically 20 minutes after the 12-volt battery-saving function has been reactivated:

- When the headlight switch is operated
- When a door is opened or closed

■ **If “Headlight System Malfunction Visit Your Dealer” is displayed on the multi-information display**

The system may be malfunctioning. Have the vehicle inspected by your Toyota dealer.

■ **Customization**

Settings (e.g. light sensor sensitivity) can be changed. (Customizable features: →P.572)

 **NOTICE**

■ **To prevent 12-volt battery discharge**

Do not leave the lights on longer than necessary when the EV system is not operating.

Turning on the high beam headlights

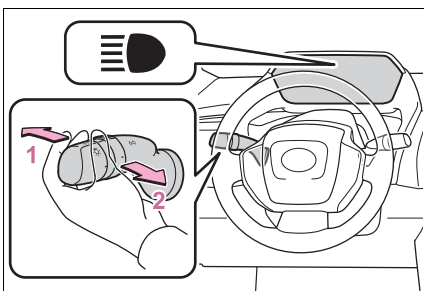

1 With the headlights on, push the lever away from you to turn on the high beams.

Pull the lever toward you to the center position to turn the high beams off.

2 Pull the lever toward you and release it to flash the high beams once.

You can flash the high beams with the headlights on or off.

AHB (Automatic High Beam)

The Automatic High Beam uses a front camera located on the upper portion of the windshield to detect the brightness of the lights of vehicles ahead, streetlights, etc., and automatically changes the headlights between the high beams and low beams.

WARNING

■ For safe use

Do not overly rely on the Automatic High Beam. Always drive safely, taking care to observe your surroundings and turning the high beams on or off manually if necessary.

■ To prevent unintentional operation of the Automatic High Beam

● When it is necessary to disable the system: →P.259

Using the Automatic High Beam system

1 Press the Automatic High Beam switch.

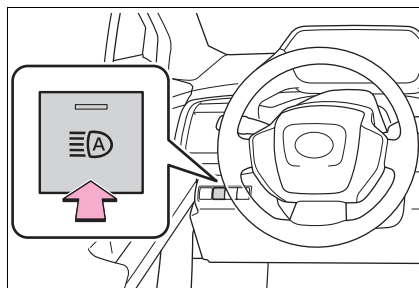

- 2 Turn the headlight switch to the AUTO or  position.

When the headlight switch lever is in the low beam position, the AHB system will be enabled and the AHB indicator will illuminate.

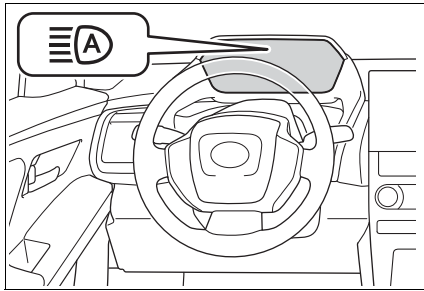

■ **Automatic operating conditions of the high beams**

- When all of the following conditions are met, the high beams will illuminate automatically:
 - Vehicle speed is approximately 21 mph (34 km/h) or more.
 - The area ahead of the vehicle is dark.
 - There are no vehicles ahead with lights on.
 - There are few streetlights or other lights on the road ahead.
- If any of the following conditions are met, the headlights will change to the low beams:
 - Vehicle speed drops below approximately 17 mph (27 km/h).
 - The area ahead of the vehicle is not dark.
 - There is a vehicle ahead with lights on.
 - There are many streetlights or other lights on the road ahead.

■ **Front camera detection**

- In the following situations, the high beams may not be automatically changed to the low beams:
 - When a vehicle cuts in front of your vehicle
 - When another vehicle crosses in

- front of the vehicle
- When vehicles ahead are repeatedly detected and then hidden due to repeated curves, road dividers or roadside trees
- When a vehicle ahead approaches from a far lane
- When a vehicle ahead is far away
- When a vehicle ahead has no lights
- When the lights of a vehicle ahead are dim
- When a vehicle ahead is reflecting strong light, such as own headlights
- Situations in which the sensors may not operate properly: →P.263
- The headlights may change to the low beams if a vehicle ahead that is using fog lights without its headlights turned on is detected.
- House lights, street lights, traffic signals, and illuminated billboards or signs may cause the high beams to change to the low beams, or the low beams to remain on.
- The following may change the timing at which the headlights change to the low beams:
 - The brightness of lights of vehicles ahead
 - The movement and direction of vehicles ahead
 - The distance between the vehicle and a vehicle ahead
 - When a vehicle ahead only has lights illuminated on one side
 - When a vehicle ahead is a two-wheeled vehicle
 - The condition of the road (gradient, curve, condition of the road surface, etc.)
 - The number of passengers and amount of luggage
- The headlights may change between the high beams and low beams unexpectedly.
- Bicycles and other small vehicles may not be detected.
- In the following situations, the system may not be able to correctly

detect the brightness of the surroundings. This may cause the low beams to remain on or the high beams to flash or dazzle pedestrians or vehicles ahead. In such a case, it is necessary to manually change between the high beams and low beams.

- When there are lights similar to headlights or tail lights in the surrounding area
- When headlights or tail lights of vehicles ahead are turned off, dirty, changing color, or not aimed properly
- When the headlights are repeatedly changing between the high beams and low beams.
- When use of the high beams is inappropriate or when the high beams may be flashing or dazzling pedestrians or other drivers.
- When the vehicle is used in an area in which vehicles travel on the opposite side of the road of the country for which the vehicle was designed, for example using a vehicle designed for right-hand traffic in a left-hand traffic area, or vice versa
- When it is necessary to disable the system: →P.259
- Situations in which the sensors may not operate properly: →P.263

■ Temporarily reducing front camera sensitivity

The sensitivity of the front camera can be temporarily reduced.

- 1 Turn the power switch off with the following conditions met.
 - The headlight switch is in  or AUTO position.
 - The headlight switch lever is in the low beam position.
 - The Automatic High Beam switch is on.
- 2 Turn the power switch to ON.
- 3 Within 60 seconds after performing step 2, push the headlight

switch lever to the high beam position then pull it to the original position quickly 10 times, then leave the lever in its original position.

- 4 If the sensitivity is changed, the Automatic High Beam indicator will blink 3 times.

Turning the high beams on/off manually

■ Changing to the high beams

Push the lever forward.

The Automatic High Beam indicator will turn off and the high beam indicator will turn on.

Pull the lever to its original position to enable the Automatic High Beam system again.

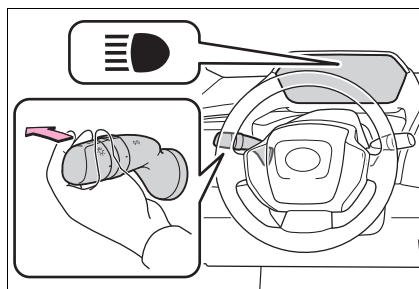

■ Changing to the low beams

Press the Automatic High Beam switch.

The Automatic High Beam indicator will turn off.

Press the switch to enable the Automatic High Beam system again.

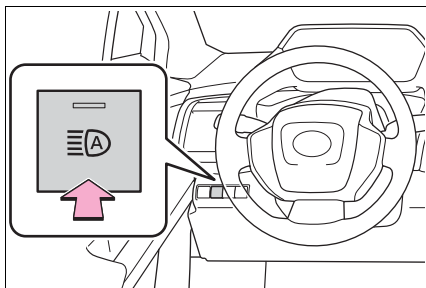

Temporarily changing to the low beams

It is recommended to switch to the low beams when use of the high beams is inappropriate or when the high beams may cause problems or distress to other drivers or pedestrians nearby.

Pull the lever rearward and then return it to its original position.

The high beams will illuminate while the lever is pulled, however, after the lever is returned to its original position, the low beams will remain on for a certain amount of time. After this, the Automatic High Beam system will operate.

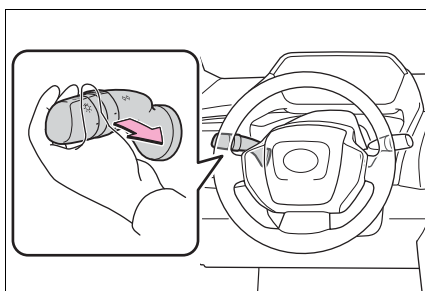

Windshield wipers and washer

Operating the lever can switch between automatic operation and manual operation, or can use the washer.

NOTICE

■ When the windshield is dry

Do not use the wipers, as they may damage the windshield.

Operating the wiper lever

Operating the lever operates the wipers or washer as follows:

► Intermittent windshield wipers

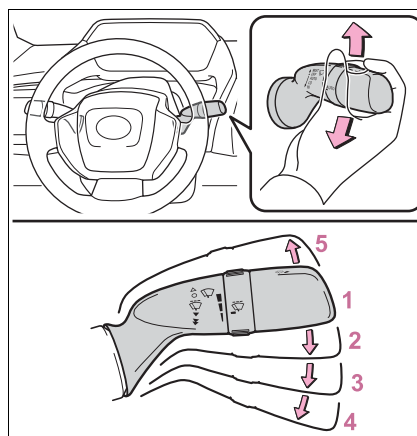

- 1** Off
- 2** Intermittent operation
- 3** Low speed operation

4 ▼ High speed operation

5 △ Temporary operation

Wiper intervals can be adjusted when intermittent operation is selected.

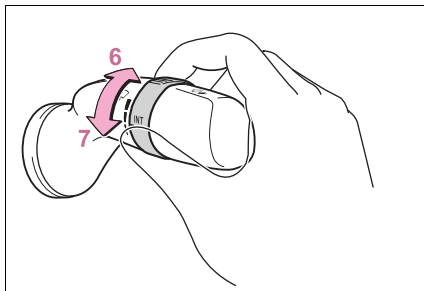

6 Increases the intermittent windshield wiper frequency

7 Decreases the intermittent windshield wiper frequency

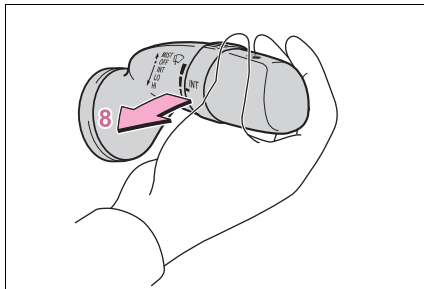

8  Washer/wiper dual operation

Pulling the lever operates the wipers and washer.

The wipers will automatically operate a couple of times after the washer squirts.

► Rain-sensing windshield wipers

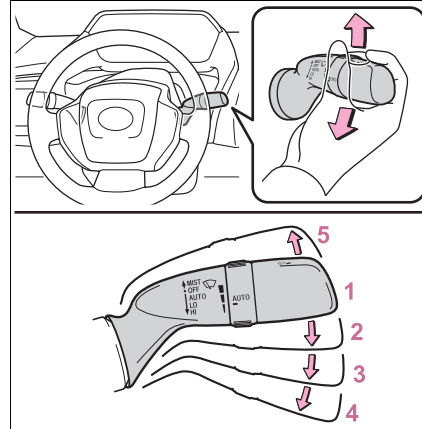

1 OFF ^{*1} or ○ ^{*2} Off

2 AUTO Rain-sensing operation

3 LO ^{*1} or ▼ ^{*2} Low speed operation

4 HI ^{*1} or ▼▼ ^{*2} High speed operation

5 MIST ^{*1} or △ ^{*2} Temporary operation

^{*1}: For the U.S.A.

^{*2}: For Canada

When "AUTO" is selected, the wipers will operate automatically when the sensor detects falling rain. The system automatically adjusts wiper timing in accordance with rain volume and vehicle speed.

The sensor sensitivity can be adjusted when "AUTO" is selected.

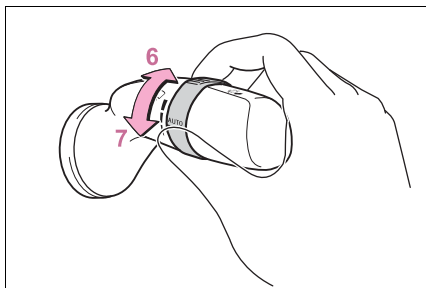

- 6 Increases the sensitivity
- 7 Decreases the sensitivity

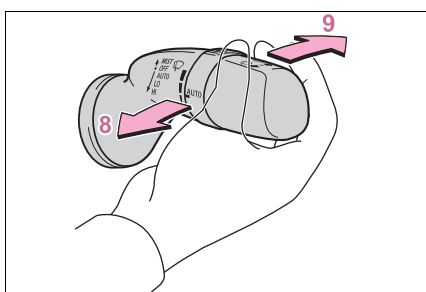

- 8  Washer/wiper dual operation

Pulling the lever operates the wipers and washer.

The wipers will automatically operate a couple of times after the washer squirts.

- 9  * Rear camera washer operation

Pushing the lever operates the rear camera washer and cleans the rear camera and the camera for the Digital Rear-view Mirror.

*: Vehicles with Digital Rear-view Mirror

■ The windshield wipers and washer can be operated when

The power switch is in ON.

■ Effects of vehicle speed on wiper operation

- ▶ Vehicles with intermittent windshield wipers

With low speed windshield wiper operation selected, wiper operation will be switched from low speed to intermittent wiper operation when the vehicle is stationary. (However, when the wiper intervals are adjusted to highest level, the mode will not switch.)

- ▶ Vehicles with rain-sensing windshield wipers

With low speed windshield wiper operation selected, wiper operation will be switched from low speed to intermittent wiper operation when the vehicle is stationary. (However, when the sensor sensitivity is adjusted to the highest level, the mode will not switch.)

■ Raindrop sensor (vehicles with rain-sensing windshield wipers)

- The raindrop sensor judges the amount of raindrops. An optical sensor is adopted. It may not operate properly when sunlight from the rising or setting of the sun intermittently strikes the windshield, or if bugs, etc., are present on the windshield.

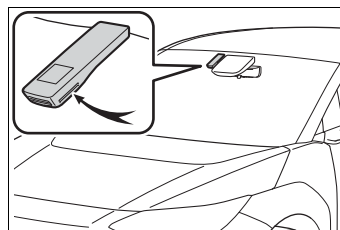

- If the wiper switch is turned to the "AUTO" position while the power switch is in ON, the wipers will operate once to show that "AUTO" mode is activated.
- If the wiper sensitivity is adjusted

to higher, the wiper may operate once to indicate the change of sensitivity.

- If the temperature of the raindrop sensor is 194°F (90°C) or higher, or 5°F (-15°C) or lower, the automatic operation may not occur. In this case, operate the wipers in any mode other than "AUTO".

■ **If no windshield washer fluid sprays**

Check that the washer nozzles are not blocked if there is washer fluid in the windshield washer fluid reservoir.

■ **When a nozzle becomes blocked**

In this case, contact your Toyota dealer. Do not try to clear it with a pin or other object. The nozzle will be damaged.

■ **To prevent 12-volt battery discharge**

Do not leave the wipers on longer than necessary when the EV system is off.

 **WARNING**

■ **Caution regarding the use of windshield wipers in "AUTO" mode (vehicles with rain-sensing windshield wipers)**

The windshield wipers may operate unexpectedly if the sensor is touched or the windshield is subject to vibration in "AUTO" mode. Take care that your fingers or anything else does not become caught in the windshield wipers.

■ **Caution regarding the use of washer fluid**

When it is cold, do not use the washer fluid until the windshield becomes warm. The fluid may freeze on the windshield and cause low visibility. This may lead to an accident, resulting in death or serious injury.

 **NOTICE**

■ **When the washer fluid tank is empty**

Do not operate the switch continually as the washer fluid pump may overheat.

Software update

It is necessary to enter a connected services contract, provided by Toyota, to use these functions. For details, contact your Toyota dealer.

⚠ WARNING**■ For safe use**

When the Toyota Safety Sense 3.0 software is updated, the operating methods of functions may change. Using this system without knowing the correct operating methods may lead to an accident resulting in death or serious injury.

- Make sure to read the Digital Owner's Manual which corresponds to the software version of the system, available at the Owner's Manual website, before using this system.

Content of the Toyota Safety Sense 3.0 Owner's Manual

This Owner's Manual contains information for Ver. 1. For the latest information about the controls, use, warnings/precautions, etc. of each function of Toyota Safety Sense 3.0, refer to the Digital Owner's Manual at the Owner's Manual website.

If the software of this system has been updated after initial purchase of the vehicle, before using this system, be sure to read the Owner's Manual which

corresponds to the software version of the system.

■ Precautions for use

- Be aware that some functions may temporarily be disabled if a legal or safety related issue occurs.
- If a connected services contract has not been entered or has expired, software updates will not be able to be performed wirelessly.

Checking your vehicle's Toyota Safety Sense 3.0 version

If the software of this system has been updated after initial purchase of the vehicle, to access the appropriate Owner's Manual, it is necessary to check the software version of the system and then visit the Owner's Manual website.

■ Checking the version using OneApp

The software version of the system can be checked using OneApp.

■ Using your vehicle's Toyota Safety Sense 3.0 version

- 1 Access the following URL using a computer or smartphone:

- ▶ For U.S.A owners

<https://www.toyota.com/owners/resources/warranty-owners-manuals/>

manual?om=om42c01u.
bz4x.2023.2203.ev.vh



► For Canadian owners

[https://www.toyota.ca/
toyota/owners/
manual?om=om42c01u.
bz4x.2023.2203.ev.vh](https://www.toyota.ca/toyota/owners/manual?om=om42c01u.bz4x.2023.2203.ev.vh)



2 Select the file which includes the previously checked system version.

Updating the software

If a software update is available, a notification will be displayed by OneApp. Follow the instructions displayed on the screen.

■ Software update precautions

- After a software update has been performed, it will not be possible to revert to a previous version.
- Depending on the communication environment and the content of an

update, a software update may take several hours. Although an update will be suspended when the power switch is turned off, it will resume when the power switch is changed back to ON.

- Toyota Safety Sense 3.0 can still be used while a software update is being performed.

■ What can be checked using the OneApp

The following items can be checked or performed.

- Software version, update details, precautions, use methods, etc.
- Software update

Toyota Safety Sense 3.0

The Toyota Safety Sense 3.0 consists of the driving assist systems and contributes to a safe and comfortable driving experience:

⚠ WARNING**■ Toyota Safety Sense 3.0**

The Toyota Safety Sense 3.0 operates under the assumption that the driver will drive safely, and is designed to help reduce the impact to the occupants in a collision and assist the driver under normal driving conditions. As there is a limit to the degree of recognition accuracy and control performance that this system can provide, do not overly rely on this system. The driver is solely responsible for paying attention to the vehicle's surroundings and driving safely.

■ For safe use

- Do not overly rely on this system. The driver is solely responsible for paying attention to the vehicle's surroundings and driving safely. This system may not operate in all situations and provided assistance is limited. Over-reliance on this system to drive the vehicle safely may lead to an accident resulting in death or serious injury.
- Do not attempt to test the operation of the system, as it may not operate properly, possibly leading to an accident.

- If attention is necessary while performing driving operations or a system malfunction occurs, a warning message or warning buzzer will be operated. If a warning message is displayed on the display, follow the instructions displayed.

- Depending on external noise, the volume of the audio system, etc. it may be difficult to hear the warning buzzer. Also, depending on the road conditions, it may be difficult to recognize the operation of the system.

■ When it is necessary to disable the system

In the following situations, make sure to disable the system.

Failure to do so may lead to the system not operating properly, possibly leading to an accident resulting in death or serious injury.

- When the vehicle is tilted due to being overloaded or having a flat tire
- When driving at extremely high speeds
- When towing another vehicle
- When the vehicle is being transported by a truck, ship, train, etc.
- When the vehicle is raised on a lift and the tires are allowed to rotate freely
- When inspecting the vehicle using a drum tester such as a chassis dynamometer or speedometer tester, or when using an on vehicle wheel balancer
- When the vehicle is driven in a sporty manner or off-road
- When using an automatic car wash

⚠ WARNING

- When a sensor is misaligned or deformed due to a strong impact being applied to the sensor or the area around the sensor
- When accessories which obstruct a sensor or light are temporarily installed to the vehicle
- When a compact spare tire or tire chains are installed to the vehicle or an emergency tire puncture repair kit has been used
- When the tires are excessively worn or the inflation pressure of the tires is low
- When tires other than the manufacturer specified size are installed
- When the vehicle cannot be driven stably, due to a collision, malfunction, etc.

Driving assist systems

- **AHB (Automatic High Beam)**
→P.250
- **PCS (Pre-Collision System)**
→P.265
- **LTA (Lane Tracing Assist)**
→P.276
- **LDA (Lane Departure Alert)**
→P.281
- **RSA (Road Sign Assist)**
→P.286

■ **Dynamic radar cruise control**

→P.288

■ **Emergency Driving Stop System**

→P.299

Sensors used by Toyota Safety Sense 3.0

Various sensors are used to obtain the necessary information for system operation.

■ **Sensors which detect the surrounding conditions**

▶ Front

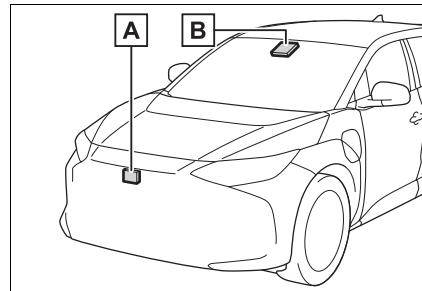

A Front radar sensor

B Front camera

▶ Rear (rear side radar sensors)

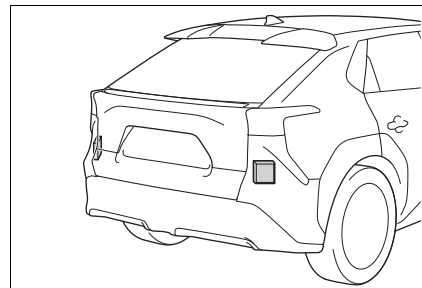

⚠ WARNING**■ To prevent malfunction of the radar sensors**

Observe the following precautions. Failure to do so may lead to a radar sensor not operating properly, possibly leading to an accident resulting in death or serious injury.

- Keep the radar sensors and radar sensor covers clean at all times.

Clean the front of a radar sensor or the front or back of a radar sensor cover if it is dirty or covered with water droplets, snow, etc.

When cleaning the radar sensor and radar sensor cover, use a soft cloth to remove dirt so as to not damage them.

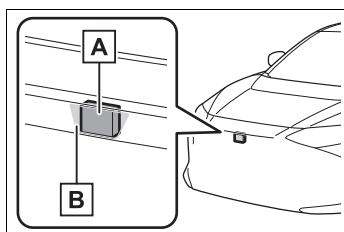

A Radar sensor

B Radar sensor cover

- Do not attach accessories, stickers (including transparent stickers), aluminum tape, etc. to a radar sensor or radar sensor cover and their surrounding area.
- Do not subject a radar sensor or its surrounding area to impact. If a radar sensor, the front grille, or front bumper has been subjected to an impact, have the vehicle inspected by your Toyota dealer.

- Do not disassemble the radar sensors.
- Do not modify or paint the radar sensors or radar sensor cover, or replace them with anything other than Toyota genuine parts.
- In the following situations, recalibration of the radar sensors will be necessary. For details, contact by your Toyota dealer.
 - When a radar sensor is removed and installed, or replaced
 - When the front bumper or the front grille has been replaced

■ Radar sensor cover with a heater

When the system determines that snow may pile up over the radar sensor cover, the heater will operate automatically. If the area around the radar sensor cover is to be touched, such as during cleaning, make sure that the radar sensor cover is cool enough to prevent burns.

■ To prevent malfunction of the front camera

Observe the following precautions. Failure to do so may lead to the front camera not operating properly, possibly leading to an accident resulting in death or serious injury.

⚠ WARNING

- Always keep the windshield clean.
- If the windshield is dirty or covered with an oily film, water droplets, snow, etc., clean the windshield.
- Even if a glass coating agent is applied to the windshield, it will still be necessary to use the windshield wipers to remove water droplets, etc. from the area of the windshield in front of the front camera.
- If the inner side of the windshield where the front camera is installed is dirty, contact your Toyota dealer
- Do not attach stickers (including transparent stickers) or other items to the area of the windshield in front of the front camera (shaded area in the illustration).

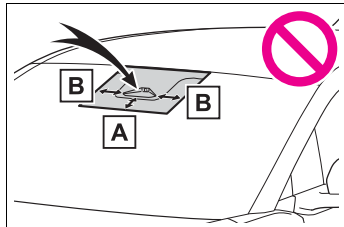

A Approximately 1.6 in. (4 cm)

B Approximately 1.6 in. (4 cm)

- If the part of the windshield in front of the front camera is fogged up or covered with condensation or ice, use the windshield defogger to remove the fog, condensation, or ice.
- If water droplets cannot be properly removed from the area of the windshield in front of the front camera by the windshield wipers, replace the wiper insert or wiper blade.

- Do not attach window tint to the windshield.
- Replace the windshield if it is damaged or cracked. If the windshield has been replaced, recalibration of the front camera will be necessary. For details, contact your Toyota dealer.
- Do not allow liquids to contact the front camera.
- Do not allow bright lights to shine into the front camera.
- Do not damage the lens of the front camera or allow it to become dirty. When cleaning the inside of the windshield, do not allow glass cleaner to contact the lens of the front camera. Do not touch the lens of the front camera. If the lens of the front camera is dirty or damaged, contact your Toyota dealer.
- Do not subject the front camera to a strong impact.
- Do not change the position or orientation of the front camera or remove it.
- Do not disassemble the front camera.
- Do not modify any parts around the front camera, such as the inside rear view mirror or ceiling.
- Do not attach accessories which may obstruct the front camera to the hood, front grille, or front bumper. For details, contact your Toyota dealer.
- If a surfboard or other long object is to be mounted on the roof, make sure that it will not obstruct the front camera.

⚠ WARNING

- Do not modify or change the headlights and other lights.

■ Front camera installation area on the windshield

If the system determines that the windshield may be fogged up, it will automatically operate the heater to defog the part of the windshield around the front camera. When cleaning, etc., be careful not to touch the area around the front camera until the windshield has cooled sufficiently, as touching it may cause burns.

- Situations in which the sensors may not operate properly**
- When the height or inclination of the vehicle has been changed due to modifications
 - When the windshield is dirty, fogged up, cracked or damaged
 - When the ambient temperature is high or low
 - When mud, water, snow, dead insects, foreign matter, etc., is attached to the front of the sensor
 - When in inclement weather such as heavy rain, fog, snow, or a sandstorm
 - When water, snow, dust, etc. is thrown up in front of the vehicle, or when driving through mist or smoke
 - When the headlights are not illuminated while driving in the dark, such as at night or when in a tunnel
 - When the lens of a headlight is dirty and illumination is weak
 - When the headlights are misaligned
 - When a headlight is malfunctioning
 - When a the headlights of another

vehicle, sunlight, or reflected light shines directly into the front camera

- When the brightness of the surrounding area changes suddenly
- When driving near a TV tower, broadcasting station, electric power plant, radar equipped vehicles, etc., or other location where strong radio waves or electrical noise may be present
- When a wiper blade is blocking the front camera
- When in a location or near objects which strongly reflect radio waves, such as the following:
 - Tunnels
 - Truss bridges
 - Gravel roads
 - Rutted, snow-covered roads
 - Walls
 - Large trucks
 - Manhole covers
 - Guardrail
 - Metal plates
- When near a step or protrusion
- When a detectable vehicle is narrow, such as a small mobility vehicle
- When a detectable vehicle has a small front or rear end, such as an unloaded truck
- When a detectable vehicle has a low front or rear end, such as a low bed trailer

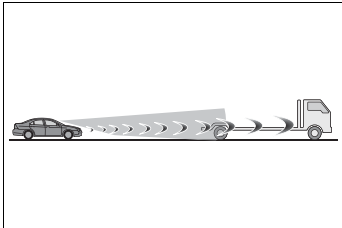

- When a detectable vehicle has extremely high ground clearance

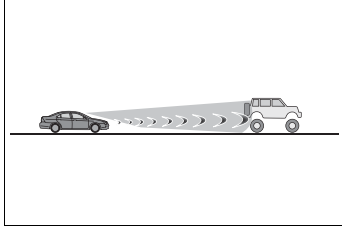

- When a detectable vehicle is carrying a load which protrudes from its cargo area
 - When a detectable vehicle has little exposed metal, such as a vehicle which is partially covered with cloth, etc.
 - When a detectable vehicle is irregularly shaped, such as a tractor, sidecar, etc.
 - When the distance between the vehicle and a detectable vehicle has become extremely short
 - When a detectable vehicle is at an angle
 - When snow, mud, etc. is attached to a detectable vehicle
 - When driving on the following kinds of roads:
 - Roads with sharp curves or winding roads
 - Roads with changes in grade, such as sudden inclines or declines
 - Roads which is sloped to the left or right
 - Roads with deep ruts
 - Roads which are rough and unmaintained
 - Roads which frequently undulate or are bumpy
 - When the steering wheel is being operated frequently or suddenly
 - When the vehicle is not in a constant position within a lane
 - When parts related to this system, the brakes, etc. are cold or extremely hot, wet, etc.
 - When the wheels are misaligned
 - When driving on slick road surfaces, such as when it is covered with ice, snow, gravel, etc.
 - When the course of the vehicle differs from the shape of a curve
 - When the vehicle speed is excessively high when entering a curve
 - When entering/exiting a parking lot, garage, car elevator, etc.
 - When driving in a parking lot
 - When driving through an area where there are obstructions which may contact your vehicle, such as tall grass, tree branches, a curtain, etc.
- **Situations in which the lane may not be detected**
- When the lane is extremely wide or narrow
 - Immediately after changing lanes or passing through an intersection
 - When driving in a temporary lane or lane regulated by construction
 - When there are structures, patterns, shadows which are similar to lane lines in the surrounding
 - When the lane lines are not clear or driving on a wet road surface
 - When a lane line is on a curb
 - When driving on a bright, reflective road surface, such as concrete
- **Situations in which some or all of the functions of the system cannot operate**
- When a malfunction is detected in this system or a related system, such as the brakes, steering, etc.
 - When the VSC, TRAC, or other safety related system is operating
 - When the VSC, TRAC, or other safety related system is off
- **Changes in brake operation sound and pedal response**
- When the brakes have been operated, brake operation sounds may be heard and the brake pedal

response may change, but this does not indicate a malfunction.

- When the system is operating, the brake pedal may feel stiffer than expected or sink. In either situation the brake pedal can be depressed further. Further depress the brake pedal as necessary.

■ **Certification**

→P.619

PCS (Pre-Collision System)

The pre-collision system uses sensors to detect objects (→P.266) in the path of the vehicle. When the system determines that the possibility of a frontal collision with a detectable object is high, a warning operates to urge the driver to take evasive action and the potential brake pressure is increased to help the driver avoid the collision. If the system determines that the possibility of a collision is extremely high, the brakes are automatically applied to help avoid the collision or help reduce the impact of the collision.

The pre-collision system can be disabled/enabled and the warning timing can be changed. (→P.275)

⚠ WARNING

■ **For safe use**

● Driving safely is solely the responsibility of the driver. Pay careful attention to the surrounding conditions in order to ensure safe driving. Never use the pre-collision system in place of normal braking operations. This system cannot help avoid or reduce the impact of a collision in every situation. Over-reliance on this system to drive the vehicle safely may lead to an accident resulting in death or serious injury.

● Although the pre-collision system is designed to help avoid or help reduce the impact of a collision, its effectiveness may change according to various conditions. Therefore, it may not always be able to achieve the same level of performance. Read the following items carefully. Do not overly rely on this system and always drive carefully.

• For safe use: →P.259

■ **When to disable the pre-collision system**

When it is necessary to disable the system: →P.259

Detectable objects

The system can detect the following as detectable objects. (Detectable objects differ depending on the function.)

- Vehicles
- Bicycles *
- Pedestrians
- Motorcycles *

*: Detected as a detectable object only when being ridden.

System functions

■ **Pre-collision warning**

When the system determines that the possibility of a collision is high, a buzzer will sound and an icon and warning message will be displayed on the multi-information display to urge the driver to take evasive action.

If the detectable object is a vehicle, moderate braking will be performed with the warning.

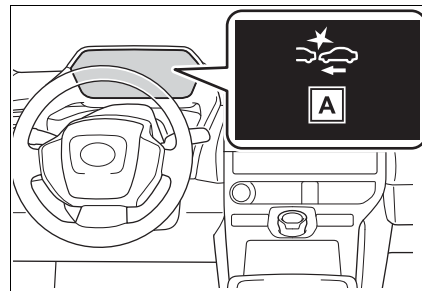

A "Pre-Collision System"

If the system determines that the accelerator pedal is strongly depressed, the following icon and message will be displayed on the multi-information display.

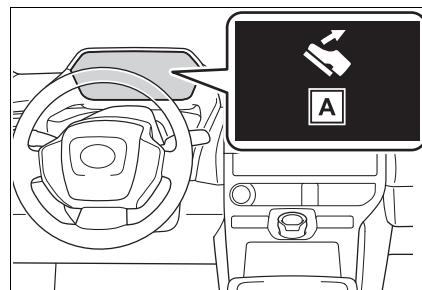

A “Accelerator Pedal is Pressed”

■ **Pre-collision brake assist**

If the system determines that the possibility of a collision is high and the brake operation by the driver is insufficient, the braking power will be increased.

■ **Pre-collision brake control**

If the system determines that the possibility of a collision is extremely high, the brakes are automatically applied to help avoid the collision or reduce the impact of the collision.

■ **Emergency steering assist**

If the system determines that the following conditions are met, assistance will be provided to help enhance vehicle stability and prevent lane departure. During assistance, in addition to the pre-collision warning, the following icon will be displayed on the multi-information display.

- The possibility of a collision is high
- There is sufficient space within the lane to perform evasive steering maneuvers
- The driver is operating the steering wheel

During assistance, the pre-collision warning will operate and a message will be displayed to warn the driver.

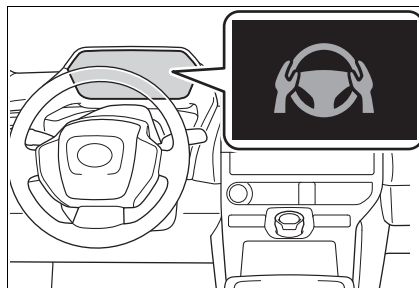

■ **Intersection collision avoidance support (left/right turn)**

In situations such as the following, if the system determines that the possibility of a collision is high, the pre-collision warning and pre-collision braking will operate. Depending on the intersection, assistance may not operate correctly.

- When turning left/right at an intersection and crossing the path of an oncoming vehicle

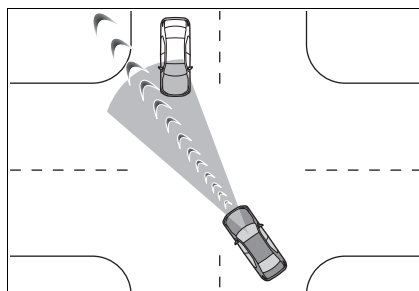

- When turning left/right and an oncoming pedestrian or bicycle is detected

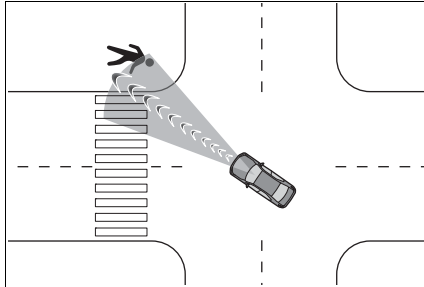

■ **Intersection collision avoidance support (crossing vehicles)**

At an intersection, etc., if the system determines that the possibility of a collision with an approaching vehicle or motorcycle is high, the pre-collision warning and pre-collision braking will operate. Depending on the intersection, assistance may not operate correctly.

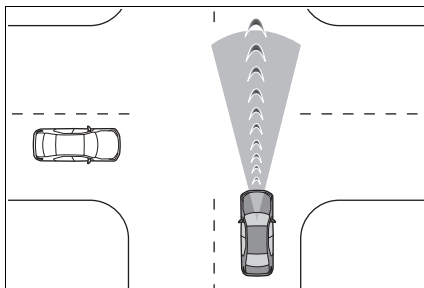

■ **Acceleration Suppression at Low Speed**

When driving at a low speed, if the accelerator pedal is strongly depressed and the system determines that there is a possibility of a collision, EV system output will be restrained or the brakes will be applied weakly to restrict acceleration. During

operation, a buzzer will sound and a warning indicator and message will be displayed on the multi-information display.

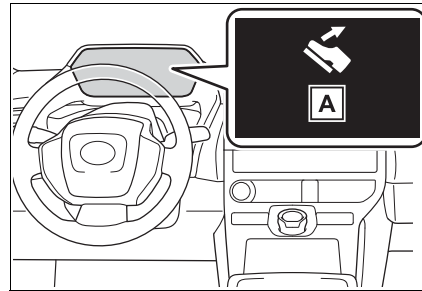

A “Accelerator Pedal is Pressed”

⚠ WARNING

■ **Pre-collision braking**

- When the pre-collision braking function is operating, a large amount of braking force will be applied.
- Pre-collision braking function is not intended for remain stopped. If the vehicle is stopped by pre-collision braking function, the driver should operate the brakes as necessary.
- The pre-collision braking function may not operate if certain operations are performed by the driver. If the accelerator pedal is being depressed strongly or the steering wheel is being turned, the system may determine that the driver is taking evasive action and possibly prevent the pre-collision braking function from operating.

⚠ WARNING

- If the brake pedal is being depressed, the system may determine that the driver is taking evasive action and possibly delay the operation timing of the pre-collision brake control.

■ Acceleration Suppression at Low Speed

If the steering wheel is being turned, the system may determine that the driver is taking evasive action and possibly prevent the Acceleration Suppression at Low Speed function from operating.

■ Emergency steering assist

- The emergency steering assist will be canceled when the system determines that lane departure prevention control has completed.
- Depending on operations performed by the driver, emergency steering assist may not operate or operation may be canceled.
- If the accelerator pedal is depressed strongly, the steering wheel is turned heavily, the brake pedal is depressed, or the turn signal lever is operated, the system may determine that the driver is taking evasive action and the emergency steering assist may not operate.
- While the emergency steering assist is operating, if the accelerator pedal is depressed strongly, the steering wheel is turned heavily, or the brake pedal is depressed, the system may determine that the driver is taking evasive action and emergency steering assist operation may be canceled.

- While the emergency steering assist is operating, if the steering wheel is held or turned in the opposite direction of system operation, emergency steering assist operation will be canceled.

■ Operating conditions of each function of the pre-collision system

The pre-collision system is enabled and the system determines that the possibility of a frontal collision with a detected object is high.

However, the system will not operate in the following situations:

- When the vehicle has not been driven a certain amount after a terminal of the 12-volt battery has been disconnected and reconnected
- When the shift position is in R
- When the VSC OFF indicator is illuminated (only the pre-collision warning function will be operational)

The following are the operational speeds and cancelation conditions of each function:

- Pre-collision warning

| Detectable objects | Vehicle speed | Relative speed between your vehicle and object |
|--|--|--|
| Preceding vehicles, stopped vehicles | Approximately 3 to 110 mph (5 to 180 km/h) | Approximately 3 to 110 mph (5 to 180 km/h) |
| Oncoming vehicles | Approximately 20 to 110 mph (30 to 180 km/h) | Approximately 50 to 130 mph (80 to 220 km/h) |
| Bicycles | Approximately 3 to 50 mph (5 to 80 km/h) | Approximately 3 to 50 mph (5 to 80 km/h) |
| Pedestrians | Approximately 3 to 50 mph (5 to 80 km/h) | Approximately 3 to 50 mph (5 to 80 km/h) |
| Preceding motorcycles, stopped motorcycles | Approximately 3 to 110 mph (5 to 180 km/h) | Approximately 3 to 50 mph (5 to 80 km/h) |
| Oncoming motorcycles | Approximately 20 to 110 mph (30 to 180 km/h) | Approximately 20 to 110 mph (30 to 180 km/h) |

While the pre-collision warning is operating, if the steering wheel is operated heavily or suddenly, the pre-collision warning may be canceled.

- Pre-collision brake assist

| Detectable objects | Vehicle speed | Relative speed between your vehicle and object |
|--------------------------------------|--|--|
| Preceding vehicles, stopped vehicles | Approximately 20 to 110 mph (30 to 180 km/h) | Approximately 7 to 110 mph (10 to 180 km/h) |
| Bicycles | Approximately 20 to 50 mph (30 to 80 km/h) | Approximately 20 to 50 mph (30 to 80 km/h) |

| Detectable objects | Vehicle speed | Relative speed between your vehicle and object |
|--|--|--|
| Pedestrians | Approximately 20 to 50 mph (30 to 80 km/h) | Approximately 20 to 50 mph (30 to 80 km/h) |
| Preceding motorcycles, stopped motorcycles | Approximately 20 to 110 mph (30 to 180 km/h) | Approximately 7 to 50 mph (10 to 80 km/h) |

● Pre-collision braking

| Detectable objects | Vehicle speed | Relative speed between your vehicle and object |
|--|--|--|
| Preceding vehicles, stopped vehicles | Approximately 3 to 110 mph (5 to 180 km/h) | Approximately 3 to 110 mph (5 to 180 km/h) |
| Oncoming vehicles | Approximately 20 to 110 mph (30 to 180 km/h) | Approximately 50 to 130 mph (80 to 220 km/h) |
| Bicycles | Approximately 3 to 50 mph (5 to 80 km/h) | Approximately 3 to 50 mph (5 to 80 km/h) |
| Pedestrians | Approximately 3 to 50 mph (5 to 80 km/h) | Approximately 3 to 50 mph (5 to 80 km/h) |
| Preceding motorcycles, stopped motorcycles | Approximately 3 to 110 mph (5 to 180 km/h) | Approximately 3 to 50 mph (5 to 80 km/h) |
| Oncoming motorcycles | Approximately 20 to 110 mph (30 to 180 km/h) | Approximately 20 to 110 mph (30 to 180 km/h) |

If either of the following occur while the pre-collision braking function is operating, it will be canceled:

- The accelerator pedal is strongly depressed
- The steering wheel is operated heavily or suddenly

● Emergency steering assist

The emergency steering assist will not operate when the turn signal lights are flashing.

| Detectable objects | Vehicle speed | Relative speed between your vehicle and object |
|--|--|--|
| Preceding vehicles, stopped vehicles, bicycles, pedestrians, motorcycles | Approximately 25 to 50 mph (40 to 80 km/h) | Approximately 25 to 50 mph (40 to 80 km/h) |

While the emergency steering assist is operating, if any of the following are performed, emergency steering assist operation may be canceled:

- The accelerator pedal is strongly depressed

- The steering wheel is operated heavily or suddenly
- The brake pedal is depressed
- Intersection collision avoidance support (left/right turn)

The intersection collision avoidance support (for left/right turning vehicles) will not operate when the turn signal lights are not flashing.

| Detectable objects | Vehicle speed | Oncoming vehicle speed | Relative speed between your vehicle and object |
|----------------------|--|--|--|
| Oncoming vehicles | Approximately 3 to 25 mph (5 to 40 km/h) | Approximately 3 to 45 mph (5 to 75 km/h) | Approximately 7 to 70 mph (10 to 115 km/h) |
| Pedestrians | Approximately 3 to 20 mph (5 to 30 km/h) | - | Approximately 3 to 25 mph (5 to 40 km/h) |
| Bicycles | Approximately 3 to 20 mph (5 to 30 km/h) | - | Approximately 3 to 30 mph (5 to 50 km/h) |
| Oncoming motorcycles | Approximately 3 to 25 mph (5 to 40 km/h) | Approximately 3 to 45 mph (5 to 75 km/h) | Approximately 7 to 70 mph (10 to 115 km/h) |

- Intersection collision avoidance support (crossing vehicles)

| Detectable objects | Vehicle speed | Crossing vehicle speed | Relative speed between your vehicle and object |
|--------------------|--|--|--|
| Vehicles (side) | Approximately 3 to 38 mph (5 to 60 km/h) | <ul style="list-style-type: none"> •Your vehicle speed or less •Approximately 25 mph (40 km/h) or less | Approximately 3 to 38 mph (5 to 60 km/h) |
| Motorcycles (side) | Approximately 3 to 38 mph (5 to 60 km/h) | <ul style="list-style-type: none"> •Your vehicle speed or less •Approximately 25 mph (40 km/h) or less | Approximately 3 to 38 mph (5 to 60 km/h) |

● Acceleration Suppression at Low Speed

The Acceleration Suppression at Low Speed function will not operate when the turn signal lights are flashing.

| Detectable objects | Vehicle speed | Relative speed between your vehicle and object |
|--------------------------------------|---|--|
| Preceding vehicles, stopped vehicles | Approximately 0 to 9 mph (0 to 15 km/h) | Approximately 0 to 9 mph (0 to 15 km/h) |
| Pedestrians | Approximately 0 to 9 mph (0 to 15 km/h) | Approximately 0 to 9 mph (0 to 15 km/h) |
| Bicycles | Approximately 0 to 9 mph (0 to 15 km/h) | Approximately 0 to 9 mph (0 to 15 km/h) |

While the Acceleration Suppression at Low Speed function is operating, if any of the following are performed, the low speed sudden acceleration suppression function operation will be canceled:

- The accelerator pedal is released
- The steering wheel is operated heavily or suddenly

■ Detection of detectable objects

Objects are detected based on their size, shape, and movement. Depending on the ambient brightness, movement, posture and direction of a detectable object, it may not be detected and the system may not operate properly. The system detects shapes, such as the following, as detectable objects.

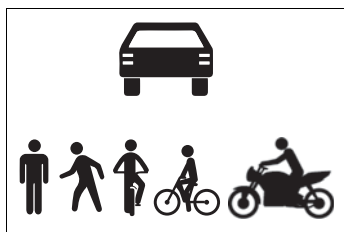

■ Situations in which the system may operate even though the possibility of a collision is not high

- In certain situations, such as the following, the system may determine that the possibility of a collision is high and operate:
 - When passing a detectable object
 - When changing lanes while overtaking a detectable object

- When suddenly approaching a detectable object
- When approaching a detectable object or other object on the roadside, such as guardrails, utility poles, trees, walls, etc.
- When there is a detectable object or other object by the roadside at the entrance of a curve

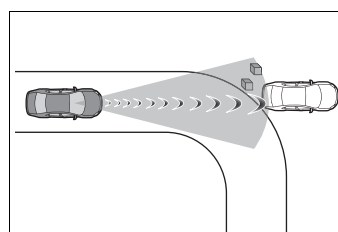

- When there are patterns or a painting ahead of the vehicle that may be mistaken for a detectable object
- When passing a detectable object that is changing lanes or turning left/right

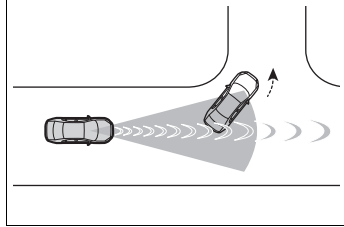

- When passing a detectable object which is stopped to make a left/right turn

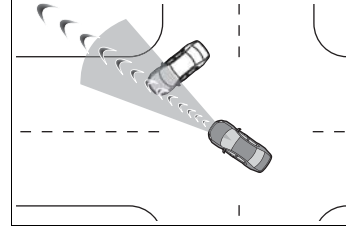

- When the steering wheel is operated toward the path of an oncoming vehicle

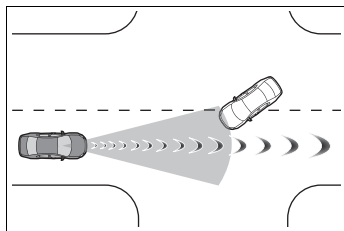

- When a detectable object stops immediately before entering the path of the vehicle
- When passing through a location with a structure above the road (traffic sign, billboard, etc.)

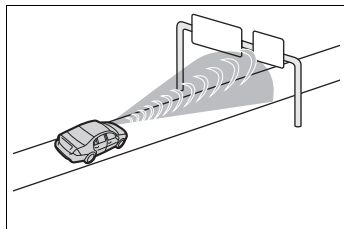

- When approaching an electric toll gate barrier, parking lot barrier, or other barrier that opens and closes
- When turning left/right and an oncoming vehicle or pedestrian crosses in front of the vehicle
- When attempting to turn left/right in front of an oncoming vehicle or pedestrian
- When turning left/right and an oncoming vehicle or pedestrian stops immediately before entering the path of the vehicle
- When turning left/right and an oncoming vehicle turns left/right in front of the vehicle

■ **Situations in which the system may not operate properly**

- In certain situations, such as the following, a detectable object may not be detected by the front sensors, and the system may not operate properly:
 - When a detectable object is approaching your vehicle
 - When your vehicle or a detectable object is wandering
 - When a detectable object makes an abrupt maneuver (such as sudden swerving, acceleration or deceleration)
 - When suddenly approaching a detectable object
 - When the detectable object is near a wall, fence, guardrail, manhole cover, steel plate on the road surface, or another vehicle
 - When there is a structure above a detectable object
 - When part of a detectable object is hidden by another object (large luggage, umbrella, guardrail, etc.)
 - When multiple detectable objects are overlapping
 - When a bright light, such as the sun, is reflecting off of a detectable object
 - When a detectable object is white and looks extremely bright
 - When the color or brightness of a detectable object causes it to blend in with its surroundings
 - When a detectable object cuts in front of or suddenly emerges in front of your vehicle
 - When approaching a vehicle which is diagonal

- If a vehicle ahead is a child sized bicycle, is carrying a large load, is carrying an extra passenger, or has an unusual shape (bicycles equipped with a child seat, tandem bicycles, etc.)
- If a pedestrian or bicycle is shorter than approximately 3.2 ft. (1 m) or taller than approximately 6.5 ft. (2 m).
- When the silhouette of a pedestrian or bicycle is unclear (such as when they are wearing a raincoat, long skirt, etc.)
- When a pedestrian or bicycle is bending forward or squatting
- When a pedestrian or bicycle is moving at high speed
- When a pedestrian is pushing a stroller, wheelchair, bicycle or other vehicle
- When a detectable object blends in with the surrounding area, such as when it is dim (at dawn or dusk) or dark (at night or in a tunnel)
- When the vehicle has not been driven for a certain amount of time after the EV system was started
- While turning left/right or a few seconds after turning left/right
- While driving around a curve and a few seconds after driving around a curve
- When turning left/right and an oncoming vehicle is driving in a lane 3 or more lanes from the vehicle
- When turning left/right and the direction of the vehicle differs greatly from the direction traffic flows in the oncoming lane

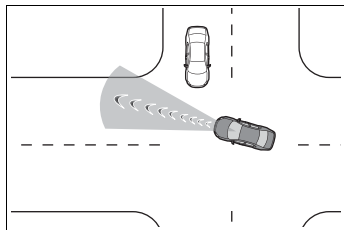

- When turning left/right and approaching a pedestrian which was traveling in the same direc-

tion as the vehicle and continues straight

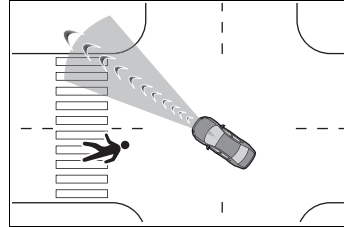

- In addition to the preceding, in certain situations, such as the following, the emergency steering assist may not operate properly:
 - When a detectable object is too close to the vehicle
 - When there is insufficient space to perform evasive steering maneuvers or an obstruction exists in the evasion direction
 - When there is an oncoming vehicle

Changing the pre-collision setting

- The pre-collision system can be enabled/disabled through a customize setting. (→P.572)

The system is enabled each time the power switch is turned to ON.

- When the system is disabled, the PCS warning light will illuminate and a message will be displayed on the multi-information display.

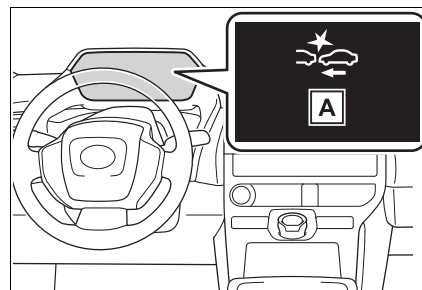

A “Pre-Collision System OFF”

- The pre-collision setting can be changed on the customize settings. (→P.572)
- When the pre-collision warning timing is changed, the emergency steering assist timing will also be changed. When “Later” is selected, the emergency steering assist will not operate in most cases.
- When the dynamic radar cruise control is operating, the pre-collision warning will operate at the “Earlier” timing, regardless of the user setting.

LTA (Lane Tracing Assist)**LTA functions**

- When driving on a road with clear lane lines with the dynamic radar cruise control operating, lane lines and preceding and surrounding vehicles are detected using the front camera and radar sensor, and the steering wheel is operated to maintain the vehicle’s lane position.

Use the this function only on highways and expressways.

If the dynamic radar cruise control is not operating, the function will not operate.

In situations where the lane lines are difficult to see or are not visible, such as when in a traffic jam, support will be provided using the path of preceding and surrounding vehicles.

If the system determines that the steering wheel has not been operated for a certain amount of time or the steering wheel is not being firmly gripped, the driver will be alerted via a display and this function will be temporarily canceled.

If the steering wheel is firmly gripped, the function will begin operating again.

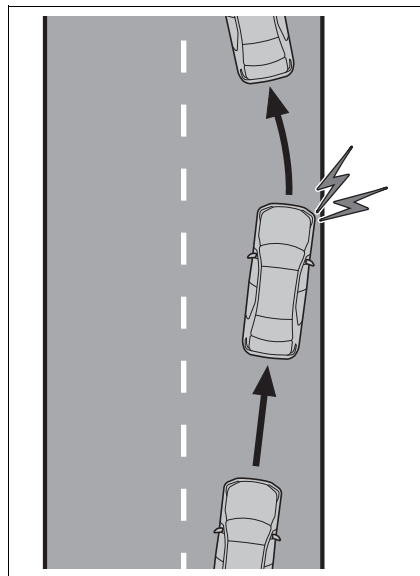
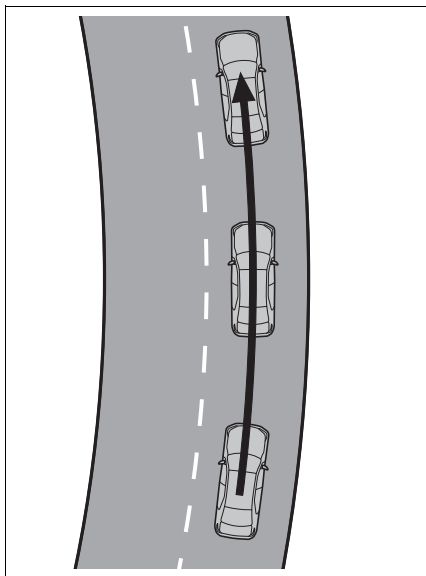

- When the function is operating, if the vehicle is likely to depart from its lane, the driver will be alerted via a display and buzzer.

When the buzzer sounds, check the area around the vehicle and carefully operate the steering wheel to move the vehicle back to the center of the lane.

⚠ WARNING

■ Before using the LTA system

- Do not overly rely on the LTA system. The LTA system is not a system which provides automated assistance in driving and it is not a system which reduces the amount of attention necessary for safe driving. The driver is solely responsible for paying attention to their surroundings and operating the steering wheel as necessary to ensure safety. Also, the driver is responsible for taking adequate breaks when fatigued, such as when driving for a long time.
- Failure to perform appropriate driving operations and pay careful attention may lead to an accident.
- When not using the LTA system, turn it off using the LTA switch.

■ Operating conditions of function

This function is operable when all of

the following conditions are met:

- The LTA system detects lane lines or the path of preceding or surrounding vehicles (except when the preceding vehicle is small, such as a motorcycle).
- The dynamic radar cruise control is operating.
- The lane width is approximately 10 to 13 ft. (3 to 4 m).
- The turn signal lever is not being operated.
- The vehicle is not being driven around a sharp curve.
- The vehicle is not accelerating or decelerating more than a certain amount.
- The steering wheel is not being turned with a large force.
- The hands off steering wheel warning (→P.278) is not operating.
- The vehicle is being driven in the center of a lane.

■ Temporary cancelation of functions

- When the operating conditions are no longer met, a function may be temporarily canceled. However, when the operation conditions are met again, operation of the function will automatically be restored. (→P.277)
- If the operating conditions of a function are no longer met while the function is operating, a buzzer may sound to indicate that the function has been temporarily canceled.
- The steering assist operation of the function can be overridden by the steering wheel operation of the driver.

■ Lane departure warning function when the LTA is operating

- Even if the LDA warning method is changed to vibration of the steering wheel, if the vehicle deviates

from the lane while the LTA is operating, the warning buzzer will sound to alert the driver.

- If steering wheel operation equivalent to that necessary for a lane change is detected, the system will determine the vehicle is not deviating from the lane and the warning will not operate.

■ Hands off steering wheel warning operation

In the following situations, a message urging the driver to grip the steering wheel and the icon shown in the illustration will be displayed on the multi-information display to warn the driver. If the system detects that the steering wheel is held, the warning will be canceled. When using the system, make sure to grip the steering wheel firmly, regardless of whether the warning is operating or not.

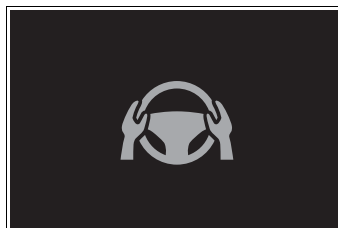

- When the system determines the driver is not holding the steering wheel while the function is operating

If no operations are detected for a certain amount of time, a buzzer will sound, the warning will operate, and the function will be temporarily canceled. This warning may also operate if the driver only operates steering wheel a small amount continuously.

Depending on the condition of the vehicle, handle control condition and road surface, the warning function may not operate.

Enabling/disabling the system

The LTA will change between enabled/disabled each time the LTA switch is pressed.

When the LTA is enabled, the LTA indicator will illuminate.

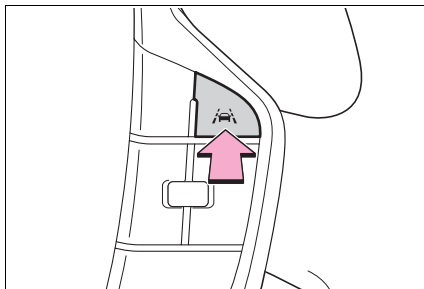

⚠ WARNING

■ **Situations in which the functions may not operate properly**

In the following situations, the functions may not operate properly and the vehicle may depart from its lane. Do not overly rely on these functions. The driver is solely responsible for paying attention to their surroundings and operating the steering wheel as necessary to ensure safety.

- When a preceding or surrounding vehicle changes lanes (Your vehicle may follow the preceding or surrounding vehicle and also change lanes)

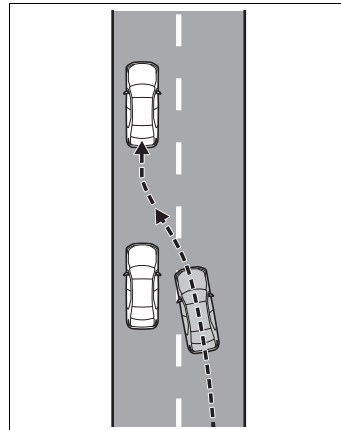









- When a preceding or surrounding vehicle is swaying (Your vehicle may sway accordingly and depart from the lane)
- When a preceding or surrounding vehicle departs from a lane (Your vehicle may follow the preceding or surrounding vehicle and also depart from the lane)
- When a preceding or surrounding vehicle is being driven extremely close to the left/right lane line (Your vehicle may follow the preceding or surrounding vehicle accordingly and depart from the lane)
- When there are moving objects or structures in the surrounding area (Depending on the position of the moving object or structure relative to your vehicle, your vehicle may sway)
- When the vehicle is struck by a crosswind or the turbulence of other nearby vehicles

⚠ WARNING

- Situations in which the sensors may not operate properly: →P.263
- Situations in which the lane may not be detected: →P.264
- When it is necessary to disable the system: →P.259

Operation display of steering wheel operation support

The operating state of the LTA system is indicated.

| Indicator | Lane display | Steering icon | Situation |
|--|--|--|--|
|  White |  Gray |  Grey | LTA is on standby |
|  Green |  Green |  Green | LTA is operating |
|  Orange Flashing |  Orange Flashing |  Green | The vehicle is departing the lane toward the side which the lane display is flashing |

LDA (Lane Departure Alert)

Basic functions

The LDA system warns the driver if the vehicle may deviate from the current lane or course*, and also can slightly operate the steering wheel to help avoid deviation from the lane or course*.

The front camera is used to detect lane lines or a course*.

*: Boundary between the asphalt and grass, soil, etc., or structures, such as a curb, guardrail, etc.

■ Lane departure alert function

When the system determines that the vehicle might depart from its lane or course*, a warning is displayed on a display, and either a warning buzzer will sound or the steering wheel will vibrate to alert the driver.

Check the area around your vehicle and carefully operate the steering wheel to move the vehicle back to the center of the lane or course*.

Vehicles with BSM: If the system determines that the vehicle may collide with a vehicle in an adjacent lane, the lane departure alert will operate even if the turn signals are operating.

*: Boundary between the asphalt and grass, soil, etc., or structures,

such as a curb, guardrail, etc.

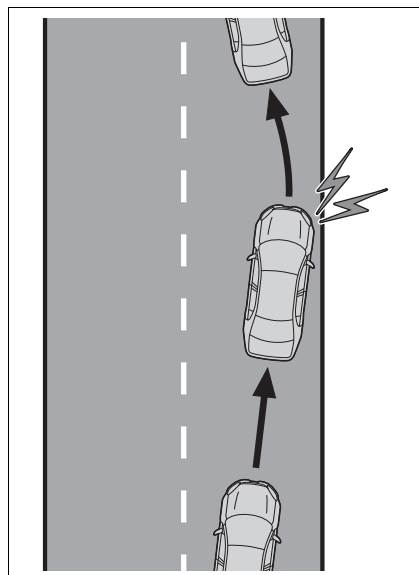

■ Lane departure prevention function

If the system determines that the vehicle is likely to depart from its lane or course*, it provides assistance through steering wheel operations to help avoid deviation from the lane or course.

If the system determines that the steering wheel has not been operated for a certain amount of time or the steering wheel is not being firmly gripped, a warning message may be displayed and a warning buzzer may sound to alert the driver.

Vehicles with BSM: If the system determines that the vehicle may collide with a vehicle in an adjacent lane, the lane departure prevention function will operate even if the turn signals are operating.

*: Boundary between the asphalt and grass, soil, etc., or structures, such as a curb, guardrail, etc.

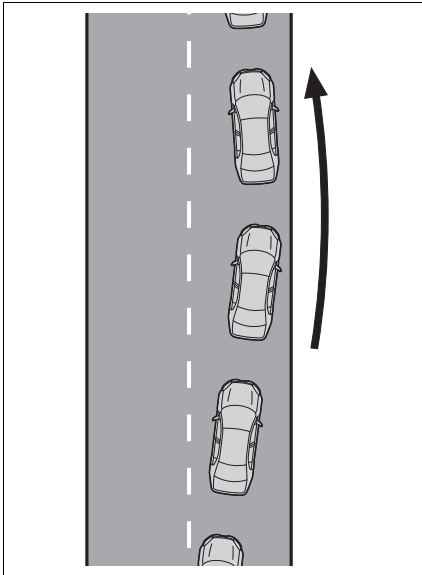

■ **Break suggestion function**

If the vehicle is swaying, a message will be displayed and a warning buzzer will sound to urge the driver to take a break.

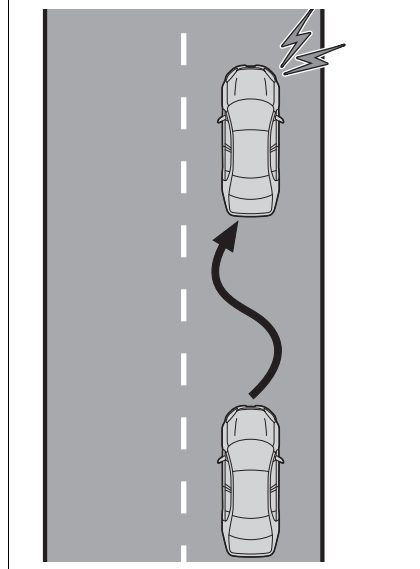

⚠ **WARNING**

■ **Before using the LDA system**

- Do not overly rely on the LDA system. The LDA system is a system which provides automated assistance in driving. However, as it is not a system which reduces the amount of attention necessary for safe driving. The driver is solely responsible for paying attention to their surroundings and operating the steering wheel as necessary to ensure safety. Also, the driver is responsible for taking adequate breaks when fatigued, such as when driving for a long time.
- Failure to perform appropriate driving operations and pay careful attention may lead to an accident.

■ **Operating conditions of each function**

- Lane departure alert/prevention function

This function is operable when all of the following conditions are met:

- The vehicle speed is approximately 30 mph (50 km/h) or more. Operation may be possible when the vehicle speed is approximately 25 mph (40 km/h) or more if vehicles, motorcycles, bicycles, or pedestrians are detected near the lane.
- The system recognizes a lane or course* . (When recognized on only one side, the system will operate only for the recognized side.)
- The lane width is approximately 9.8 ft. (3 m) or more.
- The turn signal lever is not being operated. (Vehicles with BSM: Except when a vehicle is detected in the direction that the turn signal lever is operated.)
- The vehicle is not being driven around a sharp curve.
- The vehicle is not accelerating or decelerating more than a certain amount.
- The steering wheel is not being turned sufficiently to perform a lane change.

* : Boundary between the asphalt and grass, soil, etc., or structures, such as a curb, guardrail, etc.

● Break suggestion function

This function is operable when all of the following conditions are met:

- The vehicle speed is approximately 32 mph (50 km/h) or more.
- The lane width is approximately 9.8 ft. (3 m) or more.

■ Temporary cancelation of functions

When the operating conditions are no longer met, a function may be temporarily canceled. However, when the operation conditions are met again, operation of the function will automatically be restored. (→P.282)

■ Operation of the lane departure alert function/lane departure prevention function

- Depending on the vehicle speed, road conditions, lane departure angle, etc., operation of the lane departure prevention function may not be felt or the function may not operate.
- Depending on the conditions, the warning buzzer may operate even if vibration is selected through a customize setting.
- If a course* is not clear or straight, the lane departure alert function or lane departure prevention function may not operate.
- The lane departure alert function or lane departure prevention function may not operate if the system judges that the vehicle is intentionally being steered to avoid a pedestrian or parked vehicle.
- Vehicles with BSM: It may not be possible for the system to judge if there is danger of a collision with a vehicle in an adjacent lane.
- The steering assist operation of the lane departure prevention function can be overridden by the steering wheel operation of the driver.

* : Boundary between the asphalt and grass, soil, etc., or structures, such as a curb, guardrail, etc.

■ Hands off steering wheel warning operation

In the following situations, a message urging the driver to operate the steering wheel and an icon will be displayed and a buzzer will sound to warn the driver. When using the system, make sure to grip the steering wheel firmly, regardless of whether the warning is operating or not.

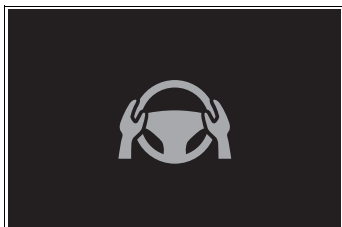

- When the system determines that the driver is not securely holding the steering wheel, or the steering wheel is not being operated when the steering assist operation of the lane departure prevention function is operating

The length of time that the warning buzzer operates will become longer as the frequency of the steering assist operating increases. Even if the system judges that the steering wheel has been operated, the warning buzzer will sound for a certain amount of time.

■ **Break suggestion function**

If the vehicle is swaying, a message will be displayed and a warning buzzer will sound to urge the driver to take a break.

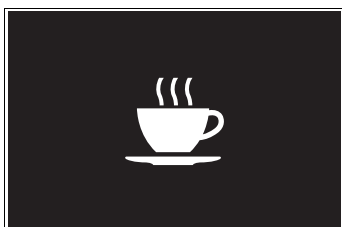

Depending on the condition of the vehicle and road surface, the break suggestion function may not operate.

Changing LDA settings

- The LDA system can be enabled/disabled through a customize setting. (→P.572)
- The settings of the LDA can

be changed through on the customize settings. (→P.572)

! WARNING

■ **Situations in which the LDA should not be used**

In the following situations, disable the LDA system. Failure to do so may lead to an accident.

- When it is necessary to disable the system: →P.259













■ **Situations in which the system may not operate properly**

In the following situations, the system may not operate properly and the vehicle may depart from its lane. Do not overly rely on these functions. The driver is solely responsible for paying attention to their surroundings and operating the steering wheel as necessary to ensure safety.

- When the boundary between the asphalt and grass, soil, etc., or structures, such as a curb, guardrail, etc. is not clear or straight
- When the vehicle is struck by a crosswind or the turbulence of other nearby vehicles
- Situations in which the lane may not be detected: →P.264
- Situations in which the sensors may not operate properly: →P.263
- Situations in which some or all of the functions of the system cannot operate: →P.264

Displays and system operation

The operating state of the lane departure alert function and steering assist operation of the lane departure prevention function are indicated.

| Indicator | Lane display | Steering icon | Condition |
|--|--|--|---|
| Not illuminated | Not illuminated | Not illuminated | System disabled |
|  White |  Gray | Not illuminated | Lane lines are not detected by the system |
|  White |  White | Not illuminated | Lane lines are detected by the system |
|  Orange Flashing |  Orange Flashing | Not illuminated | Lane departure alert function is operating for the side which the lane display is flashing |
|  Green |  Green |  Green | Lane departure prevention function is operating for the side which the lane display is illuminated |
|  Orange Flashing |  Orange Flashing |  Green | Lane departure alert function/lane departure prevention function is operating for the side which the lane display is flashing |

RSA (Road Sign Assist)

The RSA system detects specific road signs using the front camera and/or navigation system (if equipped) (when speed limit information is available) and warns the driver via displays and buzzers.

WARNING

■ For safe use

- Driving safely is solely the responsibility of the driver. Pay careful attention to the surrounding conditions in order to ensure safe driving.
- Do not rely solely upon the RSA. The RSA assists the driver by providing road sign information, but it is not a replacement for the driver's own vision and awareness. Driving safely is solely the responsibility of the driver. Pay careful attention to the surrounding conditions in order to ensure safe driving.

■ Situations in which the RSA should not be used

When it is necessary to disable the system: →P.259

■ Situations in which the system may not operate properly

Situations in which the sensors may not operate properly: →P.263

Display Function

- When the front camera detects a sign or information

of a sign is available from the navigation system (if equipped), the sign will be displayed on the display.

- Multiple signs can be displayed.

Depending on the specifications of the vehicle, the number of displayed signs may be limited.

■ Operating conditions of sign display

Signs will be displayed when the following conditions are met:

- The system has detected a sign

In the following situations, a displayed sign may stop being displayed:

- When a new sign has not been detected for a certain distance
- When the system determines that the road being driven on has changed, such as after a left or right turn

■ Situations in which the display function may not operate properly

In the following situations, the RSA system may not operate properly and may not detect signs or may display the incorrect sign. However, this does not indicate a malfunction.

- When a sign is dirty, faded, tilted or bent
- When the contrast of an electronic sign is low
- When all or part of a sign is hidden by a tree, utility pole, etc.
- When a sign is detected by the front camera for a short amount of time
- When the driving state (turning, changing lanes, etc.) is judged incorrectly
- When a sign is immediately after a

freeway junction or in an adjacent lane just before merging

- When stickers are attached to the rear of a preceding vehicle
- When a sign similar to a system compatible sign is detected as a system compatible sign
- When a speed limit sign for a frontage road is within detection range of the front camera
- When driving around a roundabout
- When a sign intended for trucks, etc. is detected
- Vehicles with navigation system: When the navigation system map data is out of date
- Vehicles with navigation system: When the navigation system cannot be used

In this case, the speed limit signs displayed on the multi-information display and navigation system display may differ.

Notification function

In the following situations, the RSA system will output a warning to notify the driver.

- If the vehicle speed exceeds the speed warning threshold of the speed limit sign displayed on the display, the sign display will be emphasized and a buzzer will sound.
- When the RSA system detects a do not enter sign and determines that the vehicle has entered a no-entry area, the do not enter sign displayed on the display will flash and a buzzer will sound.

Operating conditions of the notification functions

- Excess speed notification function

This function will operate when the following condition is met:

- A speed limit road sign is recognized by the system.

- No entry notification function





This function will operate when all of the following conditions are met:



- More than one no entry road signs are recognized by the system simultaneously.
- The vehicle is passing between no entry road signs recognized by the system.

Types of road signs supported



- The following types of road signs can be displayed.

However, non-standard or recently introduced traffic signs may not be displayed.

| | |
|---|----------------|
|  | Speed limit |
|  | |
|  | Do Not Enter |
|  | No U-turn |
|  | No Turn On Red |

| | |
|---|---------|
|  | Stop |
|  | Yield |
|  | Warning |

- Depending on the specifications of the vehicle, signs may be displayed overlapping.

| | |
|---|---------------------------|
|  | Duplicate display example |
|  | |

Changing RSA settings

The following settings of the RSA can be changed through customize settings. (→P.573)

Dynamic radar cruise control

This dynamic radar cruise control detects the presence of vehicles ahead, determines the current vehicle-to-vehicle distance, and operates to maintain a suitable distance from the vehicle ahead. The desired vehicle-to-vehicle distance can be set by operating the vehicle-to-vehicle distance switch.

Use the dynamic radar cruise control only on highways and expressways.

WARNING

■ For safe use

- Driving safely is solely the responsibility of the driver. Do not overly rely on this system, and pay careful attention to the surrounding conditions in order to ensure safe driving.
- The dynamic radar cruise control provides driving assistance to reduce the driver's burden. However, there are limitations to the assistance provided. Read the following items carefully. Do not overly rely on this system and always drive carefully.

Conditions under which the system may not operate correctly:

→P.294

⚠ WARNING

- Set the speed appropriately according to the speed limit, traffic flow, road conditions, weather conditions, etc. The driver is responsible for confirming the set speed.

- Even if the system is operating correctly, the condition of a preceding vehicle as recognized by the driver and detected by the system may differ. Therefore, it is necessary for the driver to pay attention, assess risks, and ensure safety. Over-reliance on this system to drive the vehicle safely may lead to an accident resulting in death or serious injury.

■ Precautions for the driving assist systems

Observe the following precautions, as there are limitations to the assistance provided by the system. Over-reliance on this system may lead to an accident resulting in death or serious injury.

- Details of support provided for the driver's vision The dynamic radar cruise control is only intended to help the driver in determining the distance between the driver's own vehicle and a designated preceding vehicle. It is not a system which allows for careless or inattentive driving, and is not a system which assists in poor visibility conditions. The driver must pay attention to their surroundings, even when the vehicle stops.

- Details of support provided for the driver's judgement The dynamic radar cruise control determines whether the distance between the driver's own vehicle and a designated preceding vehicle is within a set range. It is not capable of making any other type of judgement. Therefore, it is absolutely necessary for the driver to remain vigilant and to determine whether or not there is a possibility of danger.

- Details of support provided for the driver's operation The dynamic radar cruise control does not include functions which will prevent or avoid collisions with vehicles ahead of your vehicle. Therefore, if there is ever any possibility of danger, the driver must take immediate and direct control of the vehicle and act appropriately in order to ensure safety.

■ Situations in which the dynamic radar cruise control should not be used

Do not use the dynamic radar cruise control in the following situations. As the system will not be able to provide appropriate control, using it may lead to an accident resulting in death or serious injury.

- Roads where there are pedestrians, cyclists, etc.
- When driving on a highway or expressway entrance or exit
- When the approach warning sounds frequently
- Situations in which the sensors may not operate properly: →P.263
- Situations in which the lane may not be detected: →P.264

Basic functions

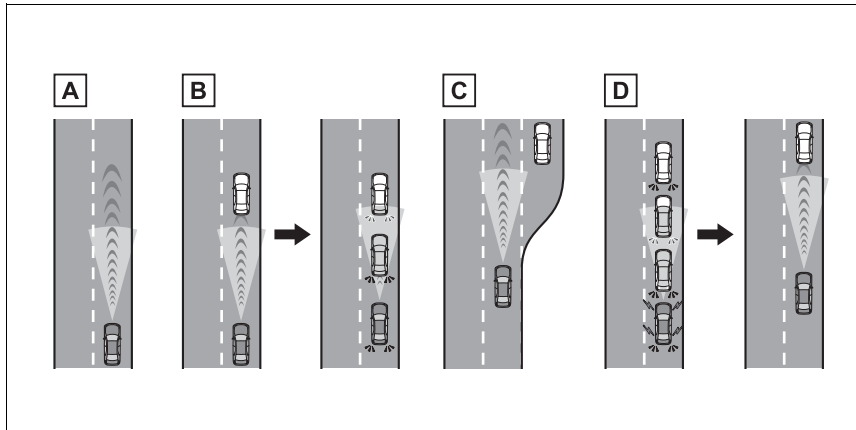

A Constant speed cruising:

When there are no vehicles ahead

The vehicle drives at the speed set by the driver.

If the set vehicle speed is exceeded while driving down a hill, the set vehicle speed display will blink and a buzzer will sound.

B Deceleration and follow-up cruising

When a preceding vehicle driving slower than the set vehicle speed is detected

When a vehicle is detected driving ahead of your vehicle, the vehicle automatically decelerates and if a greater reduction in vehicle speed is necessary, the brakes are applied (the stop lights will come on at this time). The vehicle is controlled to maintain the vehicle-to-vehicle distance set by the driver, in accordance with changes in the speed of the preceding vehicle. If vehicle deceleration is not sufficient and the vehicle approaches the vehicle ahead, the approach warning will sound.

C Acceleration

When there are no longer any preceding vehicles driving slower than the set vehicle speed

The vehicle accelerates until the set vehicle speed is reached and then resumes constant speed cruising.

D Starting off: If a preceding vehicle stops, the vehicle will also stop (controlled stop). After the preceding vehicle starts off, pressing the "RES" switch or depressing the accelerator pedal will resume follow-up cruising (start off operation). If a start off operation is not performed, the controlled stop will continue.

System components

■ Meter display

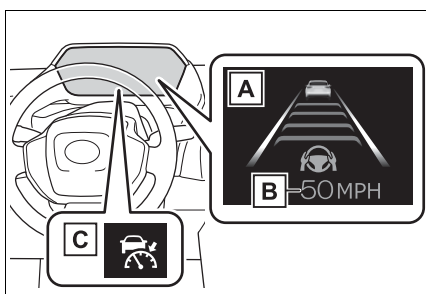

A Multi-information display

B Set vehicle speed

C Indicators

■ Switches

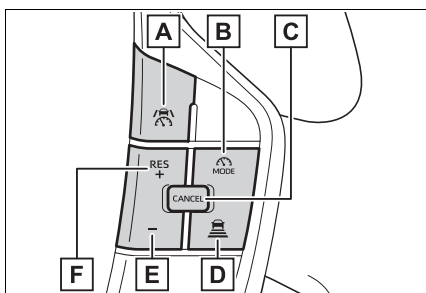

A Driving assist switch

B Driving assist mode select switch

C Cancel switch

D Vehicle-to-vehicle distance switch

E “-” switch

F “+” switch/“RES” switch

Setting the vehicle speed

- 1 Press the driving assist mode select switch to select dynamic radar cruise control.

The dynamic radar cruise control indicator will illuminate.

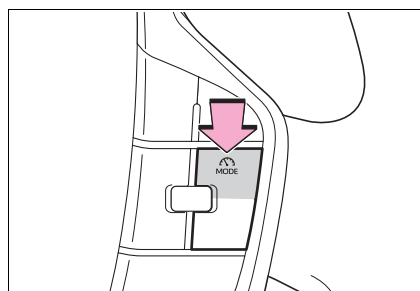

- 2 Using the accelerator pedal, accelerate or decelerate to the desired vehicle speed (approximately 20 mph [30 km/h] or more), and press the driving assist switch to set the set vehicle speed.

The set vehicle speed will be displayed on the multi-information display.

The vehicle speed at the moment the switch is released will be the set vehicle speed.

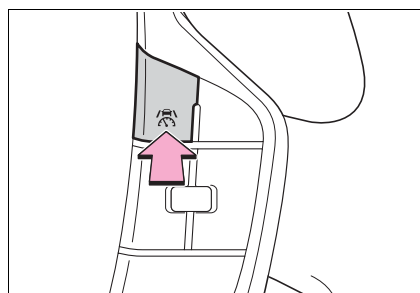

Adjusting the set vehicle speed

■ Adjusting the set vehicle speed using the switches

To change the set vehicle speed, press the “+” or “-” switch until the desired speed is displayed.

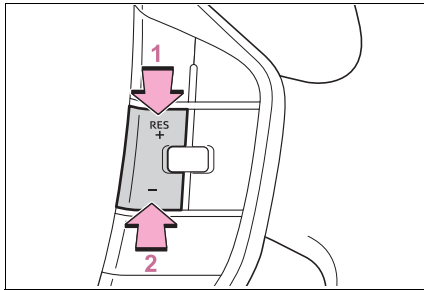

- 1 Increase set vehicle speed
- 2 Decrease set vehicle speed

Short press adjustment: Press the switch

Long press adjustment: Press and hold the switch until the desired set vehicle speed is reached.

The set vehicle speed will increase or decrease as follows:

► For U.S.A.

Short press adjustment: Increases or decreases by 1 mph (1.6 km/h) each time the switch is pressed

Long press adjustment: Increases or decreases in 1 mph (1.6 km/h) increments continuously while the switch is pressed and held

► Except for U.S.A.

Short press adjustment: By 1 km/h (0.6 mph) or 1 mph (1.6 km/h) each time the switch is pressed

Long press adjustment: Increases or decreases in 5 km/h (3.1 mph) or 5 mph (8 km/h) increments continuously while the switch is pressed and held

The set vehicle speed adjustment increment can be changed through a customize setting.

■ Increasing the set vehicle speed using the accelerator pedal

- 1 Depress the accelerator pedal to accelerate the vehicle to the desired vehicle speed.
- 2 Press the “+” switch.

Canceling/resuming control

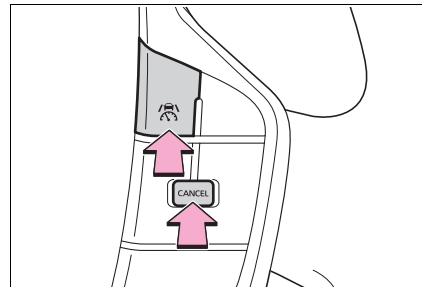

- 1 Press the cancel switch or driving assist switch to cancel control.

Control will also be canceled if the brake pedal is depressed. (If the vehicle has been stopped by system control, depressing the brake pedal will not cancel control.)

- 2 Press the “RES” switch to resume control.

Changing the vehicle-to-vehicle distance

Each time the switch is pressed, the vehicle-to-vehicle distance setting will change as follows:

If a preceding vehicle is detected, the preceding vehicle mark **A** will be displayed.

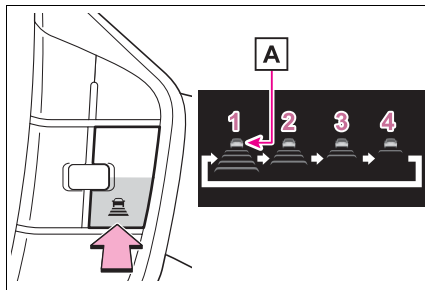

| Illustration Number | Vehicle-to-vehicle distance | Approximate Distance (Vehicle Speed: 60 mph [100 km/h]) |
|---------------------|-----------------------------|---|
| 1 | Extra long | Approximately 200 ft. (60 m) |
| 2 | Long | Approximately 145 ft. (45 m) |
| 3 | Medium | Approximately 100 ft. (30 m) |
| 4 | Short | Approximately 85 ft. (25 m) |

The actual vehicle-to-vehicle distance varies in accordance with the vehicle speed. Also, when the vehicle is stopped by system control, it will be stopped at a certain distance from the preceding vehicle, depending on the situation, regardless of the setting.

Operating conditions

- D shift position is selected.
- The desired set speed can be set when the vehicle speed is approximately 20 mph (30 km/h) or more. (If the vehicle speed is set while driving at below approximately 20 mph [30 km/h], the set speed will be set to approximately 20 mph [30 km/h].)

Accelerating after setting the vehicle speed

As with normal driving, acceleration can be performed by depressing the accelerator pedal. After accelerating, the vehicle will return to the set vehicle speed. However, while in vehicle-to-vehicle distance control mode, the vehicle speed may decrease to below the set vehicle speed in order to maintain the distance from the preceding vehicle.

When the vehicle is stopped by system control during follow-up cruising

- When the “RES” switch is pressed while the vehicle is stopped by system control, if the preceding vehicle starts off within approximately 3 seconds, follow-up cruising will resume.
- If the preceding vehicle starts off within approximately 3 seconds of the vehicle being stopped by system control, follow-up cruising will resume.

Automatic cancelation of vehicle-to-vehicle distance control mode

In the following situations, vehicle-to-vehicle distance control mode will be canceled automatically:

- When the brake control or output restriction control of a driving support system operates (For example: Pre-Collision System, drive-start control)
- When the parking brake has been

operated

- When the vehicle is stopped by system control on a steep incline
- When any of the following are detected while the vehicle is stopped by system control:
 - The driver's seat belt is unfastened
 - The driver's door is opened
 - Approximately 3 minutes have elapsed since the vehicle was stopped

The parking brake may be activated automatically.

The shift position may automatically change to P. (→P.238)

- Situations in which some or all of the functions of the system cannot operate: →P.264

■ **Dynamic radar cruise control system warning messages and buzzers**

For safe use: →P.259

■ **Preceding vehicles that the sensor may not detect correctly**

In the following situations, depending on the conditions, if the system cannot provide sufficient deceleration or acceleration is necessary, operate the brake pedal or accelerator pedal.

As the sensor may not be able to correctly detect these types of vehicles, the approach warning (→P.294) may not operate.

- When a vehicle cuts in front of your vehicle or changes lanes away from your vehicle extremely slowly or quickly
- When changing lanes
- When a preceding vehicle is driving at a low speed
- When a vehicle is stopped in the same lane as the vehicle
- When a motorcycle is traveling in the same lane as the vehicle

■ **Conditions under which the system may not operate correctly**

In the following situations, operate the brake pedal (or accelerator pedal, depending on the situation) as necessary.

As the sensor may not be able to correctly detect a vehicle, the system may not operate properly.

- When a preceding vehicle brakes suddenly
- When changing lanes at low speeds, such as in a traffic jam

Approach warning

In situations where the vehicle approaches a preceding vehicle and the system cannot provide sufficient deceleration, such as if a vehicle cuts in front of the vehicle, a warning display will flash and a buzzer will sound to alert the driver. Depress the brake pedal to ensure appropriate vehicle-to-vehicle distance.

■ **Warnings may not occur when**

In the following situations, the warning may not operate even though the vehicle-to-vehicle distance is short.

- When the preceding vehicle is traveling at the same speed or faster than your vehicle
- When the preceding vehicle is traveling at an extremely low speed
- Immediately after the vehicle speed has been set

- When the accelerator pedal is depressed

Curve speed reduction function

When a curve is detected, the vehicle speed will begin being reduced. When the curve ends, the vehicle speed reduction will end.

Depending on the situation, the vehicle speed will then return to the set vehicle speed.

In situations where vehicle-to-vehicle distance control needs to operate, such as when a preceding vehicle cuts in front of your vehicle, the curve speed reduction function will be canceled.



Situations in which the curve speed reduction function may not operate

In situations such as the following, the curve speed reduction function may not operate:

- When the vehicle is being driven around a gentle curve
- When the accelerator pedal is being depressed
- When the vehicle is being driven around an extremely short curve

Support for lane change

If your vehicle is being driven at approximately 50 mph (80 km/h) or more and a lane change to the passing lane is performed, when the turn signal lever is operated and the lane is changed, the vehicle will accelerate up to the set speed to assist in overtaking.

The system's recognition of which lane is the passing lane may be based solely on the location of the steering wheel in the vehicle (left-hand drive/right-hand drive). If the vehicle is driven in a location where the passing lane is on the opposite side of that where the vehicle was originally sold, the vehicle may accelerate when the turn signal lever is operated away from the passing lane. (e.g. The vehicle was manufactured for a right-hand traffic location, but is being driven in a left-hand traffic location. The vehicle may accelerate when the turn signal lever is operated to the right.)

If your vehicle is being driven at approximately 50 mph (80 km/h) or more and the lane is changed to that with a vehicle traveling slower than your vehicle, when the turn signal lever is operated the vehicle will gradually decelerate to assist in changing lanes.

Changing Dynamic radar cruise control settings

The settings of Dynamic radar cruise control can be changed

through customize settings.
(→P.572)

Cruise control

The vehicle can be driven at a set speed even if the accelerator pedal is not depressed.

Use the cruise control only on highways and expressways.

WARNING

■ For safe use

- Driving safely is solely the responsibility of the driver. Therefore, do not overly rely on this system. The driver is solely responsible for paying attention to the vehicle's surroundings and driving safely.
- Set the speed appropriately according to the speed limit, traffic flow, road conditions, weather conditions, etc. The driver is responsible for confirming the set speed.

■ Situations in which cruise control should not be used

Do not use the cruise control in the following situations. As the system will not be able to provide appropriate control, using it may lead to an accident resulting in death or serious injury.

- On roads with sharp bends
- On winding roads
- On slippery roads, such as those covered with rain, ice or snow

⚠ WARNING

- On steep downhills, or where there are sudden changes between sharp up and down gradients Vehicle speed may exceed the set speed when driving down a steep hill.
- When it is necessary to disable the system: →P.259

- D “-” switch
- E “+” switch/“RES” switch

Setting the vehicle speed

- 1 Press the driving assist mode select switch to select cruise control.

The cruise control indicator will illuminate.

System components

■ Meter display

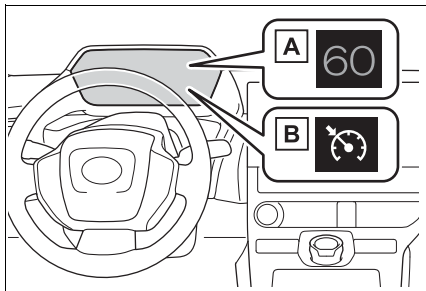

- A Set vehicle speed
- B Cruise control indicator

■ Switches

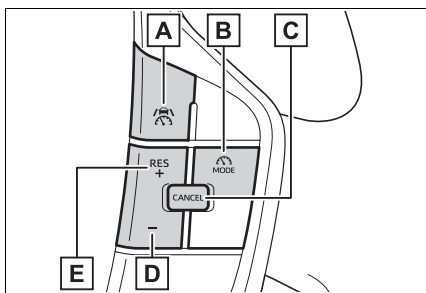

- A Driving assist switch
- B Driving assist mode select switch
- C Cancel switch

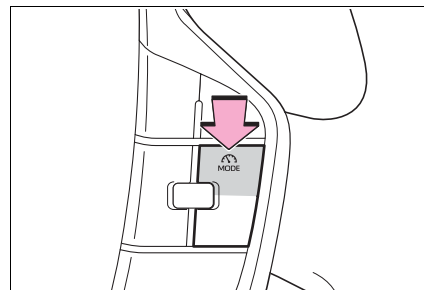

- 2 Using the accelerator pedal, accelerate to the desired vehicle speed (approximately 20 mph [30 km/h] or more), and press the driving assist switch to set the set vehicle speed.

The vehicle speed at the moment the switch is released will be the set vehicle speed.

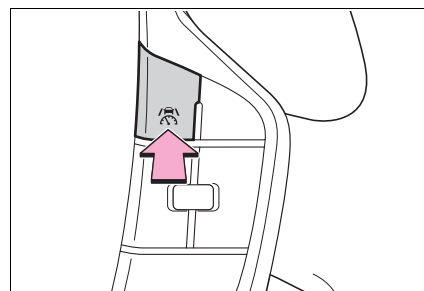

Adjusting the set vehicle speed

■ Adjusting the set vehicle speed using the switches

To change the set vehicle speed, press the “+” or “-” switch until the desired speed is displayed.

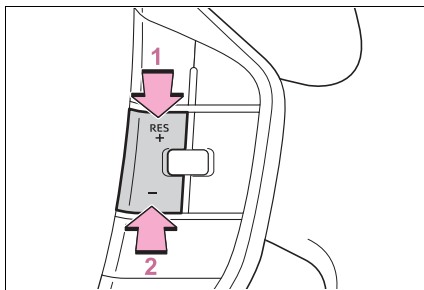

- 1 Increase set vehicle speed
- 2 Decrease set vehicle speed

The set vehicle speed will increase or decrease as follows:

Short press adjustment: By 1 mph (1.6 km/h) or 1 km/h (0.6 mph) each time the switch is pressed

Long press adjustment: Increases continuously while the switch is pressed and held

■ Increasing the set vehicle speed using the accelerator pedal

- 1 Depress the accelerator pedal to accelerate the vehicle to the desired vehicle speed.
- 2 Press the “+” switch.

Canceling/resuming control

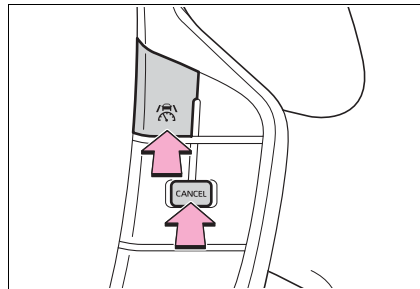

- 1 Press the cancel switch or driving assist switch to cancel control.

Control will also be canceled if the brake pedal is depressed.

- 2 Press the “RES” switch to resume control.

■ Automatic cancelation of the cruise control

In the following situations, the cruise control will be canceled automatically:

- When the vehicle speed drops approximately 10 mph (16 km/h) or more below the set vehicle speed
- When the vehicle speed drops below approximately 20 mph (30 km/h)
- When the brake control or output restriction control of a driving support system operates (For example: PCS, drive-start control)
- When the parking brake has been operated
- Situations in which some or all of the functions of the system cannot operate: →P.264

Emergency Driving Stop System

The emergency driving stop system is a system which automatically decelerates and stops the vehicle within its lane if the driver becomes unable to continue driving the vehicle, such as if they have suffered a medical emergency, etc.

During LTA (Lane Tracing Assist) control, if the system does not detect driving operations, such as if the driver is not holding the steering wheel, and determines the driver is not responsive, the vehicle will be decelerated and stopped within its current lane to help avoid a collision or reduce the impact of a collision.

WARNING

■ For safe use

- Driving safely is solely the responsibility of the driver. Pay careful attention to the surrounding conditions in order to ensure safe driving. The emergency driving stop system is designed to provide support in an emergency where it is difficult for the driver to continue driving, such as if they have had a medical emergency. It is not designed to support driving while drowsy or in poor physical health, or inattentive driving.
- Although the emergency driving stop system is designed to decelerate the vehicle within its lane to help avoid or help reduce the impact of a collision if the system determines that it is difficult for the driver to continue driving, its effectiveness may change according to various conditions. Therefore, it may not always be able to achieve the same level of performance. Also, if the operating conditions are not met, this function will not operate.
- After the emergency driving stop system operates, if driving becomes possible again, immediately begin driving again or, if necessary, park the vehicle on the shoulder of the road and set a warning reflector and flare to warn other drivers of your stopped vehicle.

⚠ WARNING

- After this system operates, passengers should attend to the driver as necessary and take appropriate hazard prevention measures, such as moving to a place where safety can be ensured, such as the shoulder of the road or behind a guard-rail.
- This system detects the condition of the driver through the operation of the steering wheel. This system may operate if the driver is aware but intentionally and continuously does not operate the vehicle. Also, the system may not operate if it cannot determine that the driver is not responsive, such as if they are leaning on the steering wheel.

Summary of the system

Operation of this system is separated into 4 control states. Through control state “warning phase 1” and “warning phase 2”, the system determines if the driver is aware and responsive while outputting a warning and controlling the vehicle speed. If the system determines the driver is not responsive, it will operate in control state “deceleration stop phase” and “stop hold phase” and decelerate and stop the vehicle. It will then operate continuously in “stop hold phase”.

■ Operating conditions

This system operates when all of the following conditions are met:

- When the LTA is on
- When the vehicle speed is approximately 30 mph (50 km/h) or more

■ Operation cancelation conditions

In the following situations, system operation will be canceled:

- When LTA control has been canceled (the LTA switch has been pressed, etc.)
- When the dynamic radar cruise control has been canceled
- When driver operations are detected (the steering wheel is held, the brake pedal, accelerator pedal, parking brake, hazard light switch, or turn signal lever is operated)
- When the driving assist switch is pressed while in the stop and hold phase
- When the power switch has been turned from ON to OFF
- Situations in which some or all of the functions of the system cannot operate: →P.264

■ LTA control when operation is canceled

When emergency driving stop system operation is canceled, LTA control may also be canceled.

Warning phase 1

If driving operations are not detected after the hands off steering wheel warning operates, a buzzer will sound intermittently and a message will be displayed to warn the driver, and the system will judge if the driver is responsive or not. If driving operations, such as holding the steering wheel, are not per-

formed within a certain amount of time, the system will enter warning phase 2.

Warning phase 2

After entering warning phase 2, a buzzer will sound in short intervals and a message will be displayed to warn the driver, and the vehicle will slowly decelerate. If driving operations, such as holding the steering wheel, are not performed within a certain amount of time, the system will determine that the driver is not responsive and enter the deceleration stop phase.

The audio system will be muted until the driver becomes responsive.

When the vehicle is decelerating, the brake lights may illuminate, depending on the road conditions, etc.

Deceleration stop phase

After entering the deceleration stop phase, a buzzer will sound continuously and a message will be displayed to warn the driver, and the vehicle will slowly decelerate and stop. After the vehicle stops, the system will enter the stop and hold phase.

Stop hold phase

After the vehicle is stopped, the parking brake will be applied

automatically. After entering the stop and hold phase, the buzzer will continue sounding continuously and the emergency flashers (hazard lights) will flash to warn other drivers of the emergency.

BSM (Blind Spot Monitor)*

*: If equipped

The Blind Spot Monitor is a system that uses rear side radar sensors installed on the inner side of the rear bumper on the left and right side to assist the driver in confirming safety when changing lanes.

WARNING

■ Cautions regarding the use of the system

- The driver is solely responsible for safe driving. Always drive safely, taking care to observe your surroundings.
- The Blind Spot Monitor is a supplementary function which alerts the driver that a vehicle is in a blind spot of the outside rear view mirrors or is approaching rapidly from behind into a blind spot. Do not overly rely on the Blind Spot Monitor. As the function cannot judge if it is safe to change lanes, over reliance could lead to an accident resulting in death or serious injury.

As the system may not function correctly under certain conditions, the driver's own visual confirmation of safety is necessary.

System components

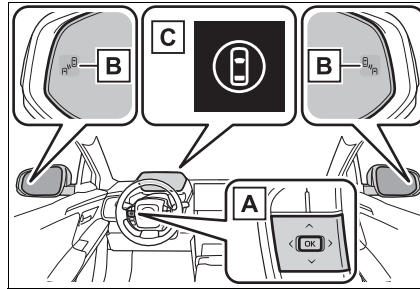

A Meter control switches

Turning the Blind Spot Monitor on/off.

B Outside rear view mirror indicators

When a vehicle is detected in a blind spot of the outside rear view mirrors or approaching rapidly from behind into a blind spot, the outside rear view mirror indicator on the detected side will illuminate. If the turn signal lever is operated toward the detected side, the outside rear view mirror indicator flashes.

C Driving assist information indicator

Illuminates when the Blind Spot Monitor is turned off. At this time, "Blind Spot Monitor OFF" will be displayed on the multi-information display.

■ Outside rear view mirror indicator visibility

In strong sunlight, the outside rear view mirror indicator may be difficult to see.

■ Customization

Some functions can be customized. (→P.573)

■ **Certification**

→P.621

⚠ **WARNING**■ **To ensure the system can operate properly**

Blind Spot Monitor sensors are installed behind the left and right sides of the rear bumper respectively. Observe the following to ensure the Blind Spot Monitor can operate correctly.

- Keep the sensors and the surrounding areas on the rear bumper clean at all times.

If a sensor or its surrounding area on the rear bumper is dirty or covered with snow, the Blind Spot Monitor may not operate and a warning message (→P.523) will be displayed. In this situation, clear off the dirt or snow and drive the vehicle with the operation conditions of the BSM function (→P.305) satisfied for approximately 10 minutes. If the warning message does not disappear, have the vehicle inspected by your Toyota dealer.

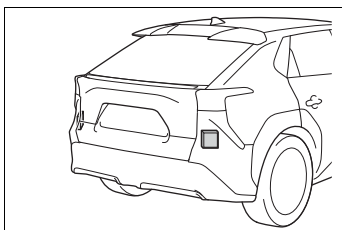

- Do not attach accessories, stickers (including transparent stickers), aluminum tape, etc., to a sensor or its surrounding area on the rear bumper.

- Do not subject a sensor or its surrounding area on the rear bumper to a strong impact. If a sensor is moved even slightly off position, the system may malfunction and vehicles may not be detected correctly. In the following situations, have your vehicle inspected by your Toyota dealer.

- A sensor or its surrounding area is subject to a strong impact.
- If the surrounding area of a sensor is scratched or dented, or part of them has become disconnected.

- Do not disassemble the sensor.

- Do not modify the sensor or surrounding area on the rear bumper.

- If a sensor or the rear bumper needs to be removed/installed or replaced, contact your Toyota dealer.

- Do not paint the rear bumper any color other than an official Toyota color.

Turning the Blind Spot Monitor on/off

The blind spot monitor can be enabled/disabled on  of the multi-information display.

(→P.156)

When the Blind Spot Monitor is off, the driving assist information indicator (→P.149) will illuminate. At this time, "Blind Spot Monitor OFF" will be displayed on the multi-information display.

Each time the power switch is turned to ON, the Blind Spot Monitor is enabled.

Blind Spot Monitor operation

■ Vehicles that can be detected by the Blind Spot Monitor

The Blind Spot Monitor uses rear side radar sensors to detect the following vehicles traveling in adjacent lanes and advises the driver of the presence of such vehicles via the indicators on the outside rear view mirrors.

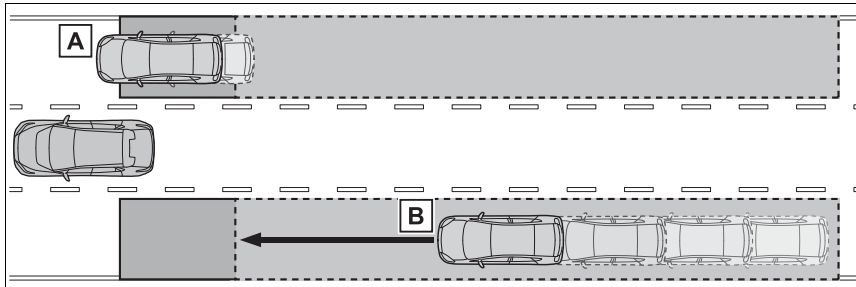

- A** Vehicles that are traveling in areas that are not visible using the outside rear view mirrors (the blind spots)
- B** Vehicles that are approaching rapidly from behind in areas that are not visible using the outside rear view mirrors (the blind spots)

■ The Blind Spot Monitor detection areas

The areas that vehicles can be detected in are outlined below.

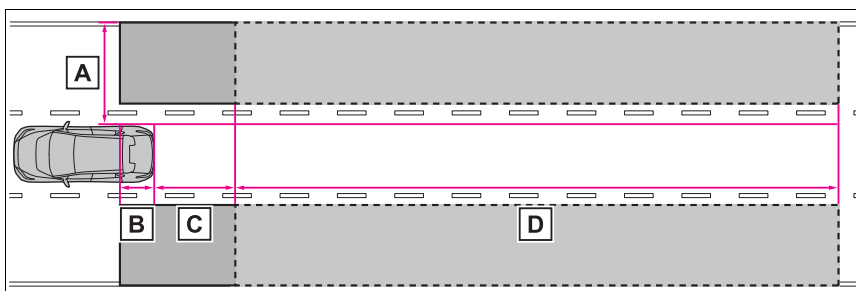

The range of each detection area is:

- A** Approximately 1.6 ft. (0.5 m) to 11.5 ft. (3.5 m) from either side of the vehicle^{*1}
- B** Approximately 3.3 ft. (1 m) forward of the rear bumper

- C** Approximately 9.8 ft. (3 m) from the rear bumper
- D** Approximately 9.8 ft. (3 m) to 197 ft. (60 m) from the rear bumper^{*2}

^{*1}: The area between the side of the vehicle and 1.6 ft. (0.5 m) from the side of the vehicle cannot be detected.

^{*2}: The greater the difference in speed between your vehicle and the detected vehicle is, the farther away the vehicle will be detected, causing the outside rear view mirror indicator to illuminate or flash.

■ The Blind Spot Monitor is operational when

The Blind Spot Monitor is operational when all of the following conditions are met:

- The power switch is in ON.
- The Blind Spot Monitor is on.
- The shift position is in a position other than R.
- The vehicle speed is greater than approximately 7 mph (10 km/h).

■ The Blind Spot Monitor will detect a vehicle when

The Blind Spot Monitor will detect a vehicle present in the detection area in the following situations:

- A vehicle in an adjacent lane overtakes your vehicle.
- You overtake a vehicle in an adjacent lane slowly.
- Another vehicle enters the detection area when it changes lanes.

■ Conditions under which the system will not detect a vehicle

The Blind Spot Monitor is not designed to detect the following types of vehicles and/or objects:

- Small motorcycles, bicycles, pedestrians, etc.,^{*}
- Vehicles traveling in the opposite direction
- Guardrails, walls, signs, parked vehicles and similar stationary objects^{*}

- Following vehicles that are in the same lane^{*}
 - Vehicles traveling 2 lanes away from your vehicle^{*}
 - Vehicles which are being overtaken rapidly by your vehicle^{*}
- ^{*}: Depending on the conditions, detection of a vehicle and/or object may occur.

■ Conditions under which the system may not function correctly

- The Blind Spot Monitor may not detect vehicles correctly in the following situations:
 - When the sensor is misaligned due to a strong impact to the sensor or its surrounding area
 - When mud, snow, ice, a sticker, etc., is covering the sensor or surrounding area on the rear bumper
 - When driving on a road surface that is wet with standing water during bad weather, such as heavy rain, snow, or fog
 - When multiple vehicles are approaching with only a small gap between each vehicle
 - When the distance between your vehicle and a following vehicle is short
 - When there is a significant difference in speed between your vehicle and the vehicle that enters the detection area
 - When the difference in speed between your vehicle and another vehicle is changing

- When a vehicle enters a detection area traveling at about the same speed as your vehicle
- As your vehicle starts from a stop, a vehicle remains in the detection area
- When driving up and down consecutive steep inclines, such as hills, dips in the road, etc.
- When driving on roads with sharp bends, consecutive curves, or uneven surfaces
- When vehicle lanes are wide, or when driving on the edge of a lane, and the vehicle in an adjacent lane is far away from your vehicle
- When an accessory (such as a bicycle carrier) is installed to the rear of the vehicle
- When there is a significant difference in height between your vehicle and the vehicle that enters the detection area
- Immediately after the Blind Spot Monitor is turned on
- When towing with the vehicle
- Instances of the Blind Spot Monitor unnecessarily detecting a vehicle and/or object may increase in the following situations:
 - When the sensor is misaligned due to a strong impact to the sensor or its surrounding area
 - When the distance between your vehicle and a guardrail, wall, etc., that enters the detection area is short
 - When driving up and down consecutive steep inclines, such as hills, dips in the road, etc.
 - When vehicle lanes are narrow, or when driving on the edge of a lane, and a vehicle traveling in a lane other than the adjacent lanes enters the detection area
 - When driving on roads with sharp bends, consecutive curves, or uneven surfaces
 - When the tires are slipping or spinning
 - When the distance between your vehicle and a following vehicle is short
- When an accessory (such as a bicycle carrier) is installed to the rear of the vehicle
- When towing with the vehicle

SEA (Safe Exit Assist)*

*: If equipped

The Safe Exit Assist is a system that uses radar sensors installed on the inner side of the rear bumper to help occupants judge if an approaching vehicle or bicycle may collide with a door to reduce the possibility of a collision.

⚠ WARNING**■ Cautions regarding the use of the system**

- The driver is solely responsible for safe driving. Always drive safely, taking care to observe your surroundings.
- Safe Exit Assist is a supplementary system that, when the vehicle is stopped, informs occupants of the existence of approaching vehicles and bicycles. As this system alone cannot be used to judge safety, over-reliance on this system may lead to an accident resulting in death or serious injury. As the system may not function correctly under certain conditions, visual confirmation of safety with the passengers' own eyes and mirrors is necessary.

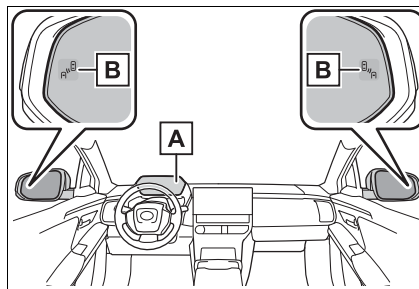
System components**A Multi-information display**

Turning the Safe Exit Assist on/off
When the system determines that the possibility of a collision with a door is high, the target door is displayed on the multi-information display. Also, if the door is opened when the outside rear view mirror indicator is illuminated, a buzzer will sound as a warning.

B Outside rear view mirror indicators

When a vehicle or bicycle which may collide with a door (other than the back door) when opened is detected, the outside rear view mirror indicator on the detected side will illuminate. If the door on the detected side is open, the outside rear view mirror indicator will blink.

■ Outside rear view mirror indicator visibility

In strong sunlight, the outside rear view mirror indicator may be difficult to see.

■ Buzzer

If the volume setting of the audio system is high or the surrounding area is loud, it may be difficult to hear the buzzer.

■ Customization

Some functions can be customized. (→P.574)

⚠ WARNING

■ To ensure the system can operate properly

Safe Exit Assist sensors are installed behind the left and right sides of the rear bumper respectively. Observe the following to ensure the Safe Exit Assist can operate correctly.

- Keep the sensors and the surrounding areas on the rear bumper clean at all times. If a sensor or its surrounding area on the rear bumper is dirty or covered with snow, the Safe Exit Assist may not operate and a warning message will be displayed. In this situation, clear off the dirt or snow and drive the vehicle with the operation conditions of the SEA function satisfied for approximately 10 minutes. If the warning message does not disappear, have the vehicle inspected by your Toyota dealer.

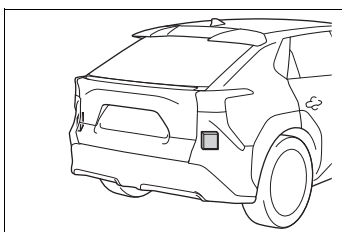

- Do not attach accessories, stickers (including transparent stickers), aluminum tape, etc., to a sensor or its surrounding area on the rear bumper.

- Do not subject a sensor or its surrounding area on the rear bumper to a strong impact. If a sensor is moved even slightly off position, the system may malfunction and vehicles may not be detected correctly. In the following situations, have the vehicle inspected by your Toyota dealer.

- A sensor or its surrounding area is subject to a strong impact.
- If the surrounding area of a sensor is scratched or dented, or part of them has become disconnected.

- Do not disassemble the sensor.
- Do not modify the sensor or surrounding area on the rear bumper.
- If a sensor or the rear bumper needs to be removed/installed or replaced, contact your Toyota dealer.
- Do not paint the rear bumper any color other than an official Toyota color.

Turning the Safe Exit Assist system on/off

The Safe Exit Assist can be enabled/disabled on  of the multi-information display.

(→P.156)

When the Safe Exit Assist is off, the driving assist information indicator (→P.149) will illuminate. At this time, “Safe Exit Assist OFF” will be displayed on the multi-information display.

Each time the power switch is turned to ON, the Safe Exit Assist is enabled.

Objects that can be detected by the Safe Exit Assist

When the Safe Exit Assist detects the following vehicles or bicycles using a rear side radar sensor, the occupants of the vehicle are informed through an outside rear view mirror indicator, buzzer, display on the meter, and voice notification.

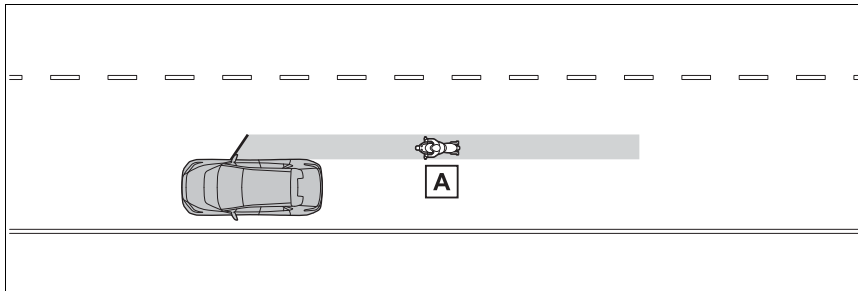

- A A Vehicle or bicycle which has a high possibility of colliding with a door (other than the back door) when opened

The Safe Exit Assist detection areas

The areas that vehicles can be detected in are outlined below.

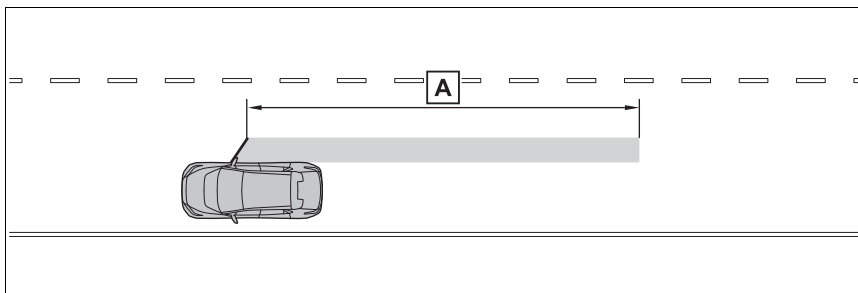

- A Approximately 145ft. (45m) rearward from the front door*

*: The faster the speed of the approaching vehicle or bicycle, the door mirror indicator will turn on or flash, the farther the vehicle or bicycle is to the door.

■ **The Safe Exit Assist is operational when**

The Safe Exit Assist is operational when all of the following conditions are met:

5
Driving

- When the EV system is running, less than 3 minutes have elapsed since the EV system was stopped, or less than 3 minutes have elapsed since a door was opened and someone has entered the vehicle (the time which operation is possible may be extended if a door is opened and closed)

- When the Safe Exit Assist is on
- The vehicle is stopped.
- The shift position is in a position other than R.

■ The Safe Exit Assist will detect a vehicle when

The Safe Exit Assist will detect a vehicle present in the detection area in the following situations:

When the vehicle is stopped and a vehicle or bicycle, which is traveling parallel to the vehicle, is approaching within the area that a door opens (other than the back door)

■ Conditions under which the system will not detect a vehicle

- Safe Exit Assist does not detect the following objects, vehicles, and bicycles:
 - Vehicles or bicycles which are approaching slowly
 - Vehicles or bicycles which are determined to have a low possibility of colliding with a door (other than the back door) when opened
 - Vehicles or bicycles which are determined to have a low possibility of colliding with a door when opened
 - Vehicles or bicycles which are approaching from directly behind
 - Vehicles or bicycles which are approaching from the front
 - Guardrails, walls, signs, parked vehicles, and other stationary objects
 - Animals, etc.
- In situations such as the following, Safe Exit Assist will not operate:
 - When 3 minutes or more have elapsed since the EV system off (the time which operation is possi-

ble may be extended if a door is opened and closed)

- When your vehicle is not completely stopped

■ Conditions under which the system may not function correctly

- Vehicles and bicycles may not be effectively detected in the following situations:
 - When the sensor is misaligned due to a strong impact to the sensor or its surrounding area
 - When mud, snow, ice, a sticker, etc., is covering the sensor or surrounding area on the rear bumper
 - When driving on a road surface that is wet with standing water during bad weather, such as heavy rain, snow, or fog
 - When a vehicle or bicycle approaches from behind a nearby parked vehicle
 - When an approaching vehicle or bicycle suddenly changes direction
 - Immediately after a vehicle or bicycle starts moving
 - When the back door is open
 - When a bicycle carrier, ramp, or other accessory is installed to the back of the vehicle
 - When a parked vehicle, wall, sign, person or other stationary object is behind the vehicle
 - When the vehicle is stopped at an angle to the road
 - When a vehicle is traveling near an approaching vehicle or bicycle
 - When an approaching vehicle or bicycle is traveling along a stationary object, such a wall or sign
 - When a vehicle or bicycle is approaching at high speed
 - When towing with the vehicle
 - When stopped on a steep incline
 - When stopped on a curve or at the exit of a curve
- Instances of the Safe Exit Assist unnecessarily detecting a vehicle and/or object may increase in the following situations:
 - When the sensor is misaligned

due to a strong impact to the sensor or its surrounding area

- When a vehicle or bicycle approaches from behind your vehicle at an angle
- When the vehicle is stopped at an angle to the road
- When a vehicle or bicycle approaches from behind a parked vehicle at an angle
- When a parked vehicle, wall, sign, person or other stationary object is behind the vehicle
- When an approaching vehicle or bicycle suddenly changes direction
- When an approaching vehicle or bicycle is traveling along a stationary object, such a wall or sign
- When the back door is open
- When a bicycle carrier, ramp, or other accessory is installed to the back of the vehicle
- When a vehicle or bicycle is approaching at high speed
- When towing with the vehicle
- When stopped on a steep incline
- When stopped on a curve or at the exit of a curve

Intuitive parking assist*

*: If equipped

The distance from your vehicle to objects, such as a wall, when parallel parking or maneuvering into a garage is measured by the sensors and communicated via the multimedia display and a buzzer. Always check the surrounding area when using this system.

System components

■ Types of sensors

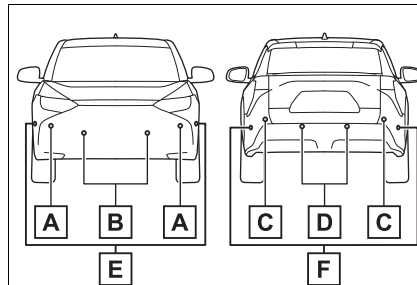

- A** Front corner sensors
- B** Front center sensors
- C** Rear corner sensors
- D** Rear center sensors
- E** Front side sensors (vehicles with Advanced Park)
- F** Rear side sensors (vehicles with Advanced Park)

5

Driving

■ Display

When the sensors detect an object, such as a wall, a graphic is shown on the multimedia display depending on the position and distance to the object. (As the distance to the object becomes short, the distance segments may blink.)

- ▶ Multimedia display (vehicles without Advanced Park)

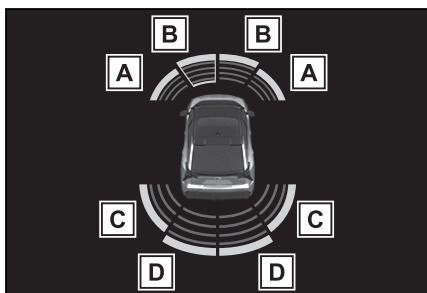

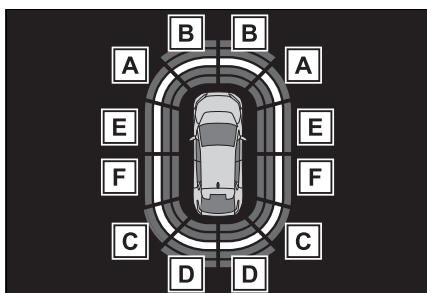

- ▶ Multimedia display (vehicles with Advanced Park)





- A** Front corner sensor detection
- B** Front center sensor detection
- C** Rear corner sensor detection
- D** Rear center sensor detection
- E** Front side sensor detection
- F** Rear side sensor detection

Turning intuitive parking assist on/off

Use the meter control switches to enable/disable the intuitive parking assist. (→P.156)

- 1 Press \wedge or \vee to select .
- 2 Press \leftarrow or \rightarrow to select  and then press OK.

When the intuitive parking assist function is disabled, the intuitive parking assist OFF indicator (→P.149) illuminates.

To re-enable the system when it was disabled, select  on the multi-information display, select  and then On. If disabled using this method, the system will not be re-enabled by turning the power switch off and then to ON.

! WARNING

■ Cautions regarding the use of the system

There is a limit to the degree of recognition accuracy and control performance that this system can provide, do not overly rely on this system. The driver is always responsible for paying attention to the vehicle's surroundings and driving safely.

■ To ensure the system can operate properly

Observe the following precautions.

Failing to do so may result in the vehicle being unable to be driven safely and possibly cause an accident.

⚠ WARNING

- Do not damage the sensors, and always keep them clean.
- Do not attach a sticker or install an electronic component, such as a backlit license plate (especially fluorescent type), fog lights, fender pole or wireless antenna near a radar sensor.
- Do not subject the surrounding area of the sensor to a strong impact. If subjected to an impact, have the vehicle inspected by your Toyota dealer. If the front or rear bumper needs to be removed/installed or replaced, contact your Toyota dealer.
- Do not modify, disassemble or paint the sensors.
- Do not attach a license plate cover.
- Keep your tires properly inflated.

■ When to disable the function

In the following situations, disable the function as it may operate even though there is no possibility of a collision.

- Failing to observe the warnings above.
- A non-genuine Toyota suspension (lowered suspension, etc.) is installed.

■ Notes when washing the vehicle

Do not apply intensive bursts of water or steam to the sensor area.

Doing so may result in the sensor malfunctioning.

- When using a high pressure washer to wash the vehicle, do not spray the sensors directly, as doing so may cause a sensor to malfunction.
- When using steam to clean the vehicle, do not direct steam too close to the sensors as doing so may cause a sensor to malfunction.

■ The system can be operated when

- The power switch is in ON.
- Intuitive parking assist function is on.
- The vehicle speed is less than about 6 mph (10 km/h).
- A shift position other than P is selected.

■ Sensor detection information

- The sensor's detection areas are limited to the areas around the vehicle's front and rear bumpers.
- The following situations may occur during use.
 - Depending on the shape of the object and other factors, the detection distance may shorten, or detection may be impossible.
 - Detection may be impossible if static objects draw too close to the sensor.
 - There will be a short delay between static object detection and display (warning buzzer sounds). Even at low speeds, there is a possibility that the object will come within 11.9 in. (30 cm) before the display is shown and the warning buzzer sounds.
 - It might be difficult to hear the buzzer due to the volume of the audio system or air flow noise of the air conditioning system.
 - It may be difficult to hear the sound of this system due to the buzzers of other systems.

■ Objects which the system may not be properly detected

The shape of the object may prevent the sensor from detecting it. Pay particular attention to the following objects:

- Wires, fences, ropes, etc.
- Cotton, snow and other materials that absorb sound waves
- Sharply-angled objects
- Low objects
- Tall objects with upper sections projecting outwards in the direction of your vehicle

People may not be detected if they are wearing certain types of clothing.

■ Situations in which the system may not operate properly

Certain vehicle conditions and the surrounding environment may affect the ability of a sensor to correctly detect objects. Particular instances where this may occur are listed below.

- There is dirt, snow, water drops or ice on a sensor. (Cleaning the sensors will resolve this problem.)
- A sensor is frozen. (Thawing the area will resolve this problem.) In especially cold weather, if a sensor is frozen the sensor display may be displayed abnormally, or objects, such as a wall, may not be detected.
- When a sensor or the area around a sensor is extremely hot or cold.

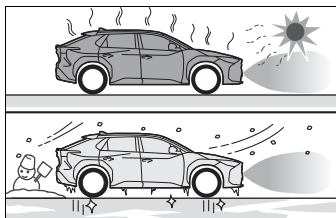

- On an extremely bumpy road, on an incline, on gravel, or on grass.

- When vehicle horns, vehicle detectors, motorcycle engines, air brakes of large vehicles, the clearance sonar of other vehicles or other devices which produce ultrasonic waves are near the vehicle
- A sensor is coated with a sheet of spray or heavy rain.
- If objects draw too close to the sensor.
- When a pedestrian is wearing clothing that does not reflect ultrasonic waves (ex. skirts with gathers or frills).
- When objects that are not perpendicular to the ground, not perpendicular to the vehicle traveling direction, uneven, or waving are in the detection range.
- Strong wind is blowing
- When driving in inclement weather such as fog, snow or a sandstorm
- When an object that cannot be detected is between the vehicle and a detected object
- If an object such as a vehicle, motorcycle, bicycle or pedestrian cuts in front of the vehicle or runs out from the side of the vehicle
- If the orientation of a sensor has been changed due to a collision or other impact
- When equipment that may obstruct a sensor is installed, such as a towing eyelet, bumper protector (an additional trim strip, etc.), bicycle carrier, or snow plow
- If the front of the vehicle is raised or lowered due to the carried load
- If the vehicle cannot be driven in a stable manner, such as when the vehicle has been in an accident or is malfunctioning
- When a tire chains, compact spare tire or an emergency tire puncture repair kit is used

■ **Situations in which the system may operate even if there is no possibility of a collision**

In some situations, such as the following, the system may operate even though there is no possibility of a collision.

- When driving on a narrow road

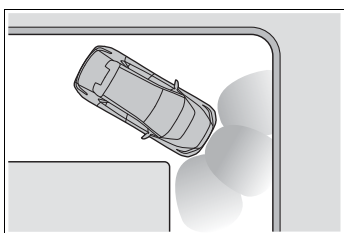

- When driving toward a banner, flag, low-hanging branch or boom barrier (such as those used at rail-road crossings, toll gates and parking lots)
- When there is a rut or hole in the surface of the road
- When driving on a metal cover (grating), such as those used for drainage ditches
- When driving up or down a steep slope
- If a sensor is hit by a large amount of water, such as when driving on a flooded road
- There is dirt, snow, water drops or ice on a sensor. (Cleaning the sensors will resolve this problem.)
- A sensor is coated with a sheet of spray or heavy rain
- When driving in inclement weather such as fog, snow or a sandstorm
- When strong winds are blowing

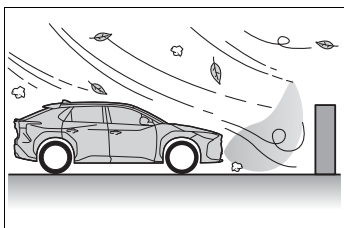

- When vehicle horns, vehicle detectors, motorcycle engines, air brakes of large vehicles, the clearance sonar of other vehicles or other devices which produce ultrasonic waves are near the vehicle
- If the front of the vehicle is raised or lowered due to the carried load
- If the orientation of a sensor has been changed due to a collision or other impact
- The vehicle is approaching a tall or curved curb
- Driving close to columns (H-shaped steel beams, etc.) in multi-story parking garages, construction sites, etc.
- If the vehicle cannot be driven in a stable manner, such as when the vehicle has been in an accident or is malfunctioning
- On an extremely bumpy road, on an incline, on gravel, or on grass

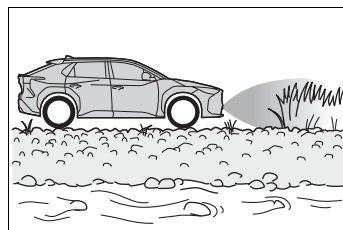

- When a tire chains, compact spare tire or an emergency tire puncture repair kit is used

Sensor detection display, object distance

■ **Detection range of the sensors (vehicles without Advanced Park)**

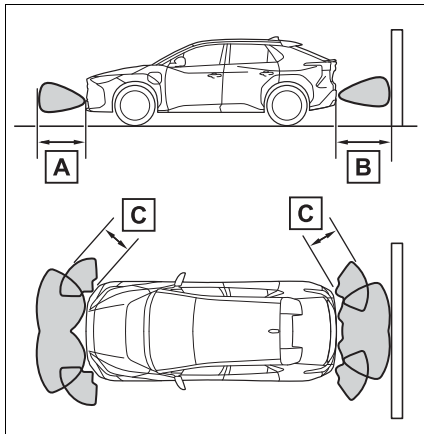

- A** Approximately 3.3 ft. (100 cm)
- B** Approximately 4.9 ft. (150 cm)
- C** Approximately 2.0 ft. (60 cm)

The diagram shows the detection range of the sensors. Note that the sensors cannot detect objects that are extremely close to the vehicle. The range of the sensors may change depending on the shape of the object, etc.,

■ **Detection range of the sensors (vehicles with Advanced Park)**

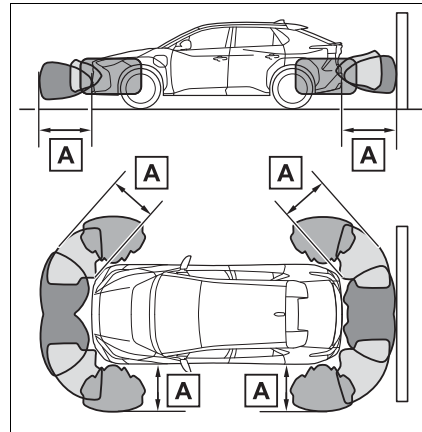

- A** Approximately 6.6 ft. (200 cm)

The diagram shows the detection range of the sensors. Note that the sensors cannot detect objects that are extremely close to the vehicle. The range of the sensors may change depending on the shape of the object, etc.,

■ The distance and buzzer

► Vehicles without Advanced Park

| Approximate distance to obstacle | Buzzer |
|---|------------|
| Front sensor: Approximately 3.3 ft. to 2.0 ft. (100 cm to 60 cm)* Rear sensor: Approximately 4.9 ft. to 2.0 ft. (150 cm to 60 cm)* | Slow |
| Approximately 2.0 ft. to 1.5 ft. (60 cm to 45 cm)* | Medium |
| Approximately 1.5 ft. to 1.0 ft. (45 cm to 30 cm)* | Fast |
| Approximately 1.0 ft. to 0.5 ft. (30 cm to 15 cm) | Continuous |
| Less than approximately 0.5 ft. (15 cm) | |

* : Automatic buzzer mute function is enabled. (→P.319)

► Vehicles with Advanced Park

| Approximate distance to obstacle | Buzzer |
|--|-------------------------------|
| Front center sensor: Approximately 6.6 ft. to 3.3 ft. (200 cm to 100 cm) Rear center sensor: Approximately 6.6 ft. to 4.9 ft. (200 cm to 150 cm) Side sensor: Approximately 6.6 ft. to 5.4 ft. (200 cm to 165 cm) Corner sensor: Approximately 6.6 ft. to 2.0 ft. (200 cm to 60 cm) | Does not sound (Display only) |
| Front center sensor: Approximately 3.3 ft. to 2.0 ft. (100 cm to 60cm)* Rear center sensor: Approximately 4.9 ft. to 2.0 ft. (150 cm to 60cm)* Side sensor: Approximately 5.4 ft. to 2.0 ft. (165 cm to 60 cm)* | Slow |
| Side sensor: Approximately 2.0 ft. to 1.3 ft. (60 cm to 40 cm)* Other than side sensor: Approximately 2.0 ft. to 1.5 ft. (60 cm to 45cm)* | Medium |

| Approximate distance to obstacle | Buzzer |
|--|------------|
| Side sensor: Approximately 1.3 ft. to 1.0 ft. (40 cm to 30 cm)* Other than side sensor: Approximately 1.5 ft. to 1.0 ft. (45cm to 30 cm)* | Fast |
| Less than approximately 1.0 ft. (30 cm) | Continuous |
| Less than approximately 0.5 ft. (15 cm) | |

*: Automatic buzzer mute function is enabled. (→P.319)

■ **Buzzer operation and distance to an object**

A buzzer sounds when the sensors are operating.

- The buzzer beeps faster as the vehicle approaches an object.
When the vehicle comes within approximately 1.0 ft. (30 cm) of the object, the buzzer sounds continuously.
- When 2 or more sensors simultaneously detect a static object, the buzzer sounds for the nearest object.
- Even when the sensors are operating, the buzzer will be muted in some situations. (automatic buzzer mute function)

■ **Adjusting the buzzer volume**

The buzzer volume can be adjusted on the multi-informa-

tion display.

Use the meter control switches to change settings. (→P.156)

- 1 Press ^ or v of the meter control switch to select ⚙ .
- 2 Press < or > of the meter control switch to select P and then press and hold OK.
- 3 Select the volume and then press OK.

Each time the switch is pressed, the volume level will change between 1, 2, and 3.

■ **Muting a buzzer temporarily**

When an object is detected, the temporary mute switch is displayed on the multimedia display system.

Select to mute a buzzer of the intuitive parking assist-sen-

sor, RCTA, and RCD all together.

Mute will be canceled automatically in the following situations:

- When the shift position is changed.
- When the vehicle speed exceeds a certain speed.
- When there is a malfunction in a sensor or the system is temporarily unavailable.
- When the operating function is disabled manually.
- When the power switch is turned off.

Object warning function (vehicles with Advanced Park)

The object warning function informs the driver of the existence of objects along the side of the vehicle, using a display and buzzer, if the objects are within the estimated path of the vehicle.

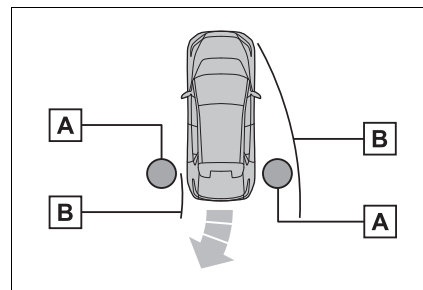

A Object

B Calculated vehicle route

When the vehicle is moving, the side sensors or side cameras can detect objects. While the vehicle is moving, if a detected object can no longer be detected by the side sensors or side cameras, the location of the object relative to the vehicle is estimated. If the object is determined to be in the estimated path of the vehicle, the object warning function will operate.

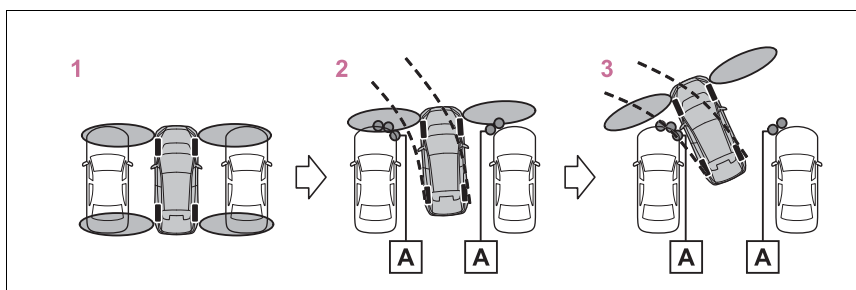

A Object detected by side sensors or side cameras

1 The vehicle is stopped and objects along the sides of the vehicle

are not detected.

- 2 Objects are detected as the vehicle is moving.
- 3 Even though the objects are outside of the detection area of the side sensors or side cameras, a warning is displayed and a buzzer sounds.

■ Object warning function operating conditions

- The Advanced Park is operating.
- The vehicle moves about 23.0 ft. (7 m) after the EV system is started.
- The R shift position is selected.
- After the D shift position has been selected, the vehicle has moved 23.0 ft. (7 m) or less.
- Camera switch has been pressed and the panoramic view monitor screen is displayed.
- The front or rear sensor detects a stationary object.

■ Detection of objects along the sides of the vehicle

- Objects along the sides of the vehicle are not instantaneously detected. The location of objects in relation to the vehicle is estimated after they are first detected by the front or rear side sensors, or side cameras. Therefore, after the power switch is changed to ON, even if an object is along the side of the vehicle, it may not be detected until the vehicle has been driven a small amount and the side sensors or side cameras completely scan the areas along the sides of the vehicle.
- If a vehicle, person, animal, etc., is detected by a side sensors or side cameras, but then leaves the detection area of the side sensors or side cameras, the system will assume the object has not moved.

⚠ WARNING

■ Side sensors and side cameras

In situations such as the following, the function may not operate correctly, possibly leading to an accident. Proceed carefully.

- When starting off shortly after the power switch is turned to ON and a small vehicle or other object which cannot be detected by a front side sensor is next to the vehicle.

In the situation shown in the following illustration, even if the vehicle starts off, the vehicle on the left will not be detected and the object warning function will not operate.

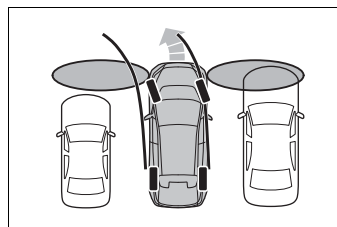

- When an object or person is in a position which cannot be detected by the side sensors or side cameras.
- When, after the side sensors have completed scanning the areas along the sides of the vehicle, a vehicle, person, or other object approaches the side of the vehicle and cannot be detected.

 **WARNING**

- When the outside rear view mirror is closed, the side sensors or side cameras cannot detect objects.
- If the 12-volt battery was discharged or has been removed and installed, fold and extend the outside rear view mirrors.

RCTA (Rear Cross Traffic Alert)*

*: If equipped

The RCTA function uses the BSM rear side radar sensors installed behind the rear bumper. This function is intended to assist the driver in checking areas that are not easily visible when backing up.

 **WARNING**

■ **Cautions regarding the use of the system**

The driver is solely responsible for safe driving. Always drive safely, taking care to observe your surroundings.

The RCTA function is only a supplementary function which alerts the driver that a vehicle is approaching from the right or left at the rear of the vehicle.

As the RCTA function may not function correctly under certain conditions, the driver's own visual confirmation of safety is necessary.

Over reliance on this function may lead to an accident resulting death or serious injury.

■ **To ensure the system can operate properly**

→P.303

System components

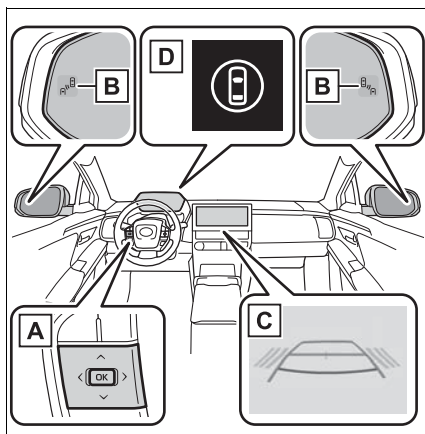

A Meter control switches

Turning the RCTA function on/off.

B Outside rear view mirror indicators

When a vehicle approaching from the right or left at the rear of the vehicle is detected, both outside rear view mirror indicators will flash.

C Multimedia display

If a vehicle approaching from the right or left at the rear of the vehicle is detected, the RCTA icon (→P.324) for the detected side will be displayed on the multimedia display. This illustration shows an example of a vehicle approaching from both sides of the vehicle.

D Driving assist information indicator

When the RCTA is off, “Rear Cross Traffic Alert OFF” will be displayed on the multi-information display.

Turning the RCTA function on/off

The RCTA can be enabled/disabled on  of the multi-information display. (→P.156)

When the RCTA function is off, the driving assist information indicator (→P.149) will illuminate. At this time, “Rear Cross Traffic Alert OFF” will be displayed on the multi-information display. Each time the power switch is turned to ON, the RCTA function is enabled.

■ Outside rear view mirror indicator visibility

In strong sunlight, the outside rear view mirror indicator may be difficult to see.

■ Hearing the RCTA buzzer

The RCTA buzzer may be difficult to hear over loud noises, such as high audio volume.

■ Radar sensors

→P.303

RCTA function

■ Operation of the RCTA function

The RCTA function uses radar sensors to detect vehicles approaching from the right or left at the rear of the vehicle and alerts the driver of the presence of such vehicles by flashing the outside rear view mirror indicators and sounding a buzzer.

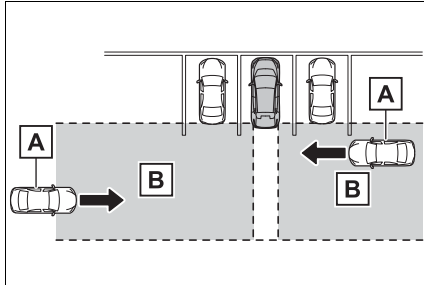

- A** Approaching vehicles
- B** Detection areas of approaching vehicles

■ **RCTA icon display**

When a vehicle approaching from the right or left at the rear of the vehicle is detected, the following will be displayed on the multimedia display.

This illustration shows an example of a vehicle approaching from both sides of the vehicle.

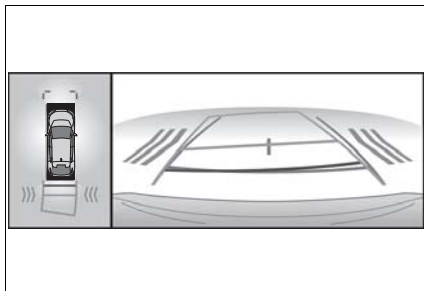

■ **RCTA function detection areas**

The areas that vehicles can be detected in are outlined below.

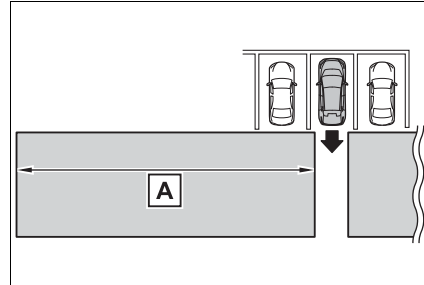

The buzzer can alert for faster vehicles approaching from farther away.

Example:

| Approaching vehicle | Speed | A Approximate alert distance |
|---------------------|------------------|--|
| Fast | 34 mph (56 km/h) | 131 ft. (40 m) |
| Slow | 5 mph (8 km/h) | 18 ft. (5.5 m) |

■ **The RCTA function is operational when**

The RCTA function operates when all of the following conditions are met:

- The power switch is in ON.
- The RCTA function is on.
- The shift position is in R.
- The vehicle speed is less than approximately 9 mph (15 km/h).
- The approaching vehicle speed is between approximately 5 mph (8 km/h) and 34 mph (56 km/h).

■ **Adjusting the buzzer volume**

The buzzer volume can be adjusted on the multi-information display.

The volume of the RCTA buzzer can be adjust on of the multi-infor-

mation display. (→P.319)

■ **Muting a buzzer temporarily**

When an object is detected, the temporary mute switch is displayed on the multimedia display system.

Select  to mute a buzzer of the intuitive parking assist-sensor, RCTA and RCD all together.

Mute will be canceled automatically in the following situations:

- When the shift position is changed.
- When the vehicle speed exceeds a certain speed.
- When there is a malfunction in a sensor or the system is temporarily unavailable.
- When the operating function is disabled manually.
- When the power switch is turned off.

■ **Conditions under which the system will not detect a vehicle**

The RCTA function is not designed to detect the following types of vehicles and/or objects:

- Vehicles approaching from directly behind
- Vehicles backing up in a parking space next to your vehicle
- Vehicles that the sensors cannot detect due to obstructions

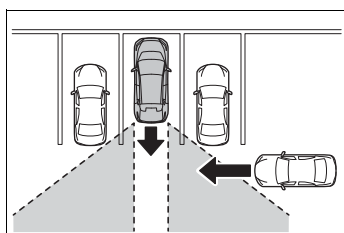

- Guardrails, walls, signs, parked vehicles and similar stationary objects*
- Small motorcycles, bicycles,

pedestrians, etc.*

- Vehicles moving away from your vehicle
- Vehicles approaching from the parking spaces next to your vehicle*
- The distance between the sensor and approaching vehicle gets too close

*: Depending on the conditions, detection of a vehicle and/or object may occur.

■ **Situations in which the system may not operate properly**

The RCTA function may not detect vehicles correctly in the following situations:

- When the sensor is misaligned due to a strong impact to the sensor or its surrounding area
- When mud, snow, ice, a sticker, etc., is covering the sensor or surrounding area on the position above the rear bumper
- When driving on a road surface that is wet with standing water during bad weather, such as heavy rain, snow, or fog
- When multiple vehicles are approaching with only a small gap between each vehicle
- When a vehicle is approaching at high speed
- When equipment that may obstruct a sensor is installed, such as a towing eyelet, bumper protector (an additional trim strip, etc.), bicycle carrier, or snow plow
- When backing up on a slope with a sharp change in grade

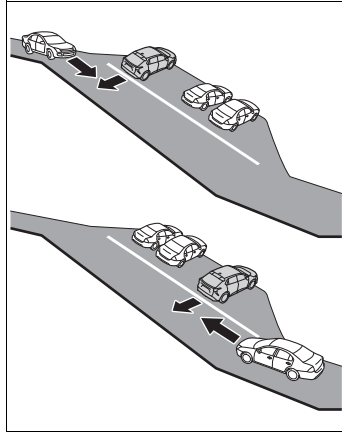

- When backing out of a sharp angle parking spot

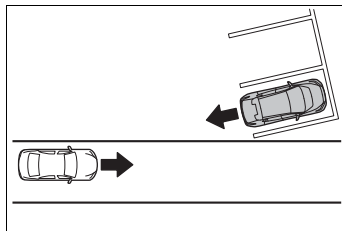

- Immediately after the RCTA function is turned on
- Immediately after the EV system is started with the RCTA function on
- When the sensors cannot detect a vehicle due to obstructions
- When towing a trailer
- When there is a significant difference in height between your vehicle and the vehicle that enters the detection area
- When a sensor or the area around a sensor is extremely hot or cold
- If the suspension has been modified or tires of a size other than specified are installed
- If the front of the vehicle is raised or lowered due to the carried load
- When turning while backing up

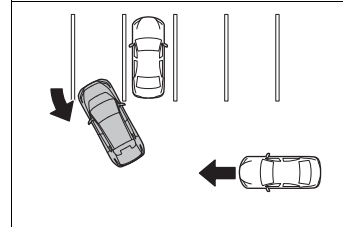

- When a vehicle turns into the detection area

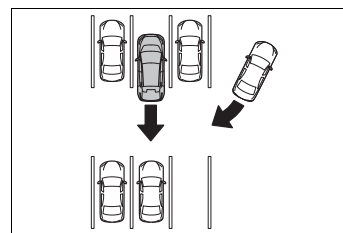

- **Situations in which the system may operate even if there is no possibility of a collision**

Instances of the RCTA function unnecessarily detecting a vehicle and/or object may increase in the following situations:

- When the parking space faces a street and vehicles are being driven on the street

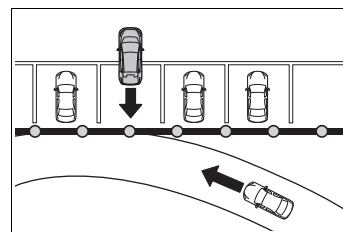

- When the distance between your vehicle and metal objects, such as a guardrail, wall, sign, or parked vehicle, which may reflect electrical waves toward the rear of the vehicle, is short

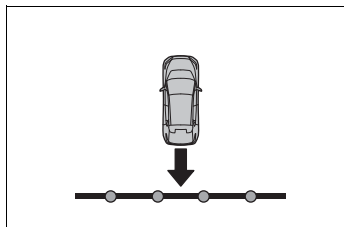

- When equipment that may obstruct a sensor is installed, such as a towing eyelet, bumper protector (an additional trim strip, etc.), bicycle carrier, or snow plow
- When a vehicle passes by the side of your vehicle

- When a sensor or the area around a sensor is extremely hot or cold
- If the suspension has been modified or tires of a size other than specified are installed
- If the front of the vehicle is raised or lowered due to the carried load

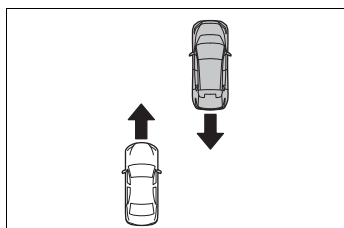

- When a detected vehicle turns while approaching the vehicle

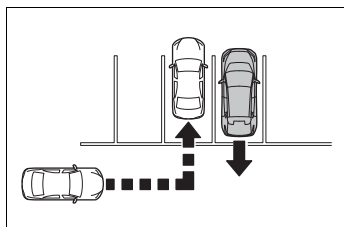

- When there are spinning objects near your vehicle such as the fan of an air conditioning unit
- When water is splashed or sprayed toward the rear bumper, such as from a sprinkler
- Moving objects (flags, exhaust fumes, large rain droplets or snowflakes, rain water on the road surface, etc.)
- When the distance between your vehicle and a guardrail, wall, etc., that enters the detection area is short
- Gratings and gutters

RCD (Rear Camera Detection)*

*: If equipped

When the vehicle is backing up, the rear camera detection function can detect pedestrians in the detection area behind the vehicle. If a pedestrian is detected, a buzzer will sound and an icon will be displayed on the multimedia display to inform the driver of the pedestrian.

WARNING

■ Cautions regarding the use of the system

The recognition and control capabilities for this system are limited.

The driver should always drive safely by always being responsible without over relying on the system and have a understanding of the surrounding situations.

■ To ensure the system can operate properly

Observe the following, otherwise there is the danger that could lead to an accident.

- Always clean the camera without damaging it.
- Do not install market electronic parts (such as illuminated license plate, fog lamps, etc.) in the camera vicinity.
- Do not subject the camera vicinity to strong impacts. If the vicinity is subjected to a strong impact, have the vehicle inspected at a Toyota dealer.

- Do not disassemble, remodel or paint the camera.
- Do not attach accessories or stickers to the camera.
- Do not install market protection parts (bumper trim, etc.) to the rear bumper.
- Maintain suitable tire air pressure.
- Make sure the back door is completely closed.
- **RCD function is turned off**
In the following situations the system turns off. The RCD function may not operate properly and thus there is the danger that an accident may occur.
- The contents mentioned above are not observed
- Suspensions other than Toyota genuine parts are installed

Multimedia display

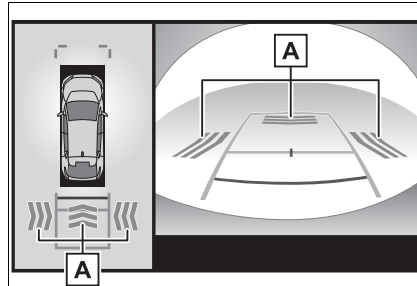

A Pedestrian detection icon

Displayed automatically when a pedestrian is detected.

(Each time the power switch is turned off then changed to ON, the RCD function will be enabled automatically.)

Turning the RCD function on/off

Use the meter control switches to enable/disable the RCD function. (→P.156)

- 1 Press \wedge or \vee to select .
- 2 Press \leftarrow or \rightarrow to select "RCD" and then press OK.

When the RCD function is disabled, the driving assist information indicator (→P.149) illuminates. At this time, the RCD indicator and "Rear Camera Detection OFF" will be displayed on the multi-information display.

When a pedestrian is detected

If the rear camera detection function detects a pedestrian in the detection area, the buzzer and pedestrian detection will operate as follows:

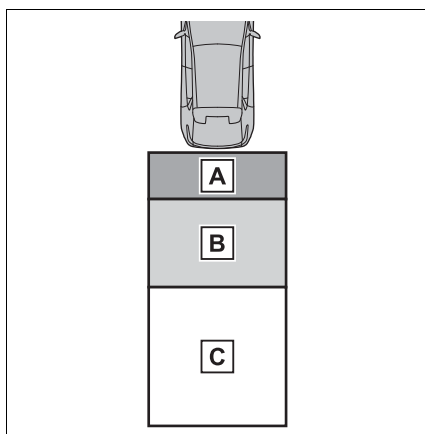

A If a pedestrian is detected in

area **A**
 Buzzer: Sounds repeatedly
 Pedestrian detection icon:
 Blinks

B If a pedestrian is detected in area **B**
 Buzzer (When the vehicle is stationary): Sounds 3 times
 Buzzer (When the vehicle is backing up, when a pedestrian approaches the rear of the vehicle): Sounds repeatedly
 Pedestrian detection icon:
 Blinks

C If the system determines that your vehicle may collide with a pedestrian in area **C**
 Buzzer: Sounds repeatedly
 Pedestrian detection icon:
 Blinks

The rear camera detection function is operational when

- The power switch is in ON.
- RCD function is on.
- The shift position is in R.
- Advanced Park is not operating.

Setting the buzzer volume

The buzzer volume can be adjusted on the multi-information display. (→P.319)

Use the meter control switches to change settings. (→P.156)

Muting a buzzer temporarily

When an object is detected, the temporary mute switch is displayed on the multimedia display system.

Select  to mute a buzzer of the

intuitive parking assist-sensor, RCTA, and RCD all together.

Mute will be canceled automatically in the following situations:

- When the shift position is changed.
- When the vehicle speed exceeds a certain speed.
- When there is a malfunction in a sensor or the system is temporarily unavailable.
- When the operating function is disabled manually.
- When the power switch is turned off.

■ **Situations in which the system may not operate properly**

- Some pedestrians, such as the following, may not be detected by the rear camera detection function, preventing the function from operating properly:
 - Pedestrians who are bending forward or squatting
 - Pedestrians who are lying down
 - Pedestrians who are running
 - Pedestrians who suddenly enter the detection area
 - People riding a bicycle, skateboard, or other light vehicle
 - Pedestrians wearing oversized clothing such as a rain coat, long skirt, etc., making their silhouette obscure
 - Pedestrians whose body is partially hidden by an object, such as a cart or umbrella
 - Pedestrians which are obscured by darkness, such as at night
- In some situations, such as the following, pedestrians may not be detected by the rear camera detection function, preventing the function from operating properly:
 - When backing up in inclement weather (rain, snow, fog, etc.)
 - When the rear camera is obscured (dirt, snow, ice, etc., are attached) or scratched
 - When a very bright light, such as

the sun, or the headlights of another vehicle, shines directly into the rear camera

- When backing up in a place where the surrounding brightness changes suddenly, such as at the entrance or exit of a garage or underground parking lot
- When backing up in a dim environment such as during dusk or in an underground parking lot
- When the camera position and direction are deviated
- When a towing hook is attached
- When water droplets are flowing on the camera lens
- When the vehicle height is extremely changed (nose up, nose down).
- When tire chains or an emergency tire puncture repair kit is used
- When the rear washer is operating
- If the suspension has been modified or tires of a size other than specified are installed.
- If an electronic component, such as a backlit license plate or rear fog light, is installed near the rear camera
- If a bumper protector, such as an additional trim strip, is installed to the rear bumper

■ **Situations in which the system may operate unexpectedly**

- Even though there are no pedestrians in the detection area, some objects, such as the following, may be detected, possibly causing the rear camera detection function to operate.
 - Three dimensional objects, such as a pole, traffic cone, fence, or parked vehicle
 - Moving objects, such as a car or motorcycle
 - Objects moving toward your vehicle when backing up, such as flags or puddles (or airborne matter, such as smoke, steam, rain, or snow)
 - Cobblestone or gravel roads, tram rails, road repairs, white lines, pedestrian crossings or fallen

- leaves on the road
- Metal covers (gratings), such as those used for drainage ditches
- Objects reflected in a puddle or on a wet road surface
- Shadows on the road
- In some situations, such as the following, the rear camera detection function may operate even though there are no pedestrians in the detection area.
 - When backing up toward the roadside or a bump on the road
 - When backing up toward an incline/decline
 - If the rear of the vehicle is raised or lowered due to the carried load
 - If a bumper protector, such as an additional trim strip, is installed to the rear bumper
 - If the orientation of the rear camera has been changed
 - If a towing eyelet is installed to the rear of the vehicle
 - When water is flowing over the rear camera lens
 - When the rear camera is obscured (dirt, snow, ice, etc., are attached) or scratched
 - If there is a flashing light in the detection area, such as the emergency flashers of another vehicle
 - When a tire chains or an emergency tire puncture repair kit is used
- Situations in which the rear camera detection function may be difficult to notice
 - The buzzer may be difficult to hear if the surrounding area is noisy, the volume of the audio system is high, the air conditioning system is being used, etc.
 - If the temperature in the cabin is extremely high or low, the audio system screen may not operate correctly.

PKSB (Parking Support Brake)*

*: If equipped

The Parking Support Brake system consists of the following functions that operate when driving at a low speed or backing up, such as when parking. When the system determines that the probability of a collision with a detected object or pedestrian is high, a warning operates to urge the driver to take evasive action. If the system determines that the possibility of a collision with a detected object or pedestrian is extremely high, the brakes are automatically applied to help avoid the collision or help reduce the impact of the collision.

PKSB (Parking Support Brake) system

- **Static Objects Front and Rear of the Vehicle (if equipped)**
→P.336
- **Moving Vehicles Rear of the Vehicle (if equipped)**
→P.339

■ **Pedestrians Rear of the Vehicle (if equipped)**

→P.342

■ **Static Objects Around the Vehicle (vehicles with Advanced Park)**

→P.340

 **WARNING**

■ **Cautions regarding the use of the system**

Do not overly rely on the system, as doing so may lead to an accident.

Always drive while checking the safety of the surroundings of the vehicle.

Depending on the vehicle and road conditions, weather, etc., the system may not operate.

The detection capabilities of sensors and radars are limited. Always drive while checking the safety of the surroundings of the vehicle.

● The driver is solely responsible for safe driving. Always drive carefully, taking care to observe your surroundings. The Parking Support Brake system is designed to provide support to lessen the severity of collisions. However, it may not operate in some situations.

● The Parking Support Brake system is not designed to stop the vehicle completely. Additionally, even if the system has stopped the vehicle, it is necessary to depress the brake pedal immediately as brake control will be canceled after approximately 2 seconds.

● It is extremely dangerous to check the system operations by intentionally driving the vehicle into the direction of a wall, etc. Never attempt such actions.

■ **When to disable the Parking Support Brake**

In the following situations, disable the Parking Support Brake as the system may operate even though there is no possibility of a collision.

- When inspecting the vehicle using a chassis roller, chassis dynamo or free roller
- When loading the vehicle onto a boat, truck or other transport vessel
- If the suspension has been modified or tires of a size other than specified are installed
- If the front of the vehicle is raised or lowered due to the carried load
- When equipment that may obstruct a sensor is installed, such as a towing eyelet, bumper protector (an additional trim strip, etc.), bicycle carrier, or snow plow
- When using automatic car washing devices
- If the vehicle cannot be driven in a stable manner, such as when the vehicle has been in an accident or is malfunctioning
- When the vehicle is driven in a sporty manner or off-road
- When the tires are not properly inflated
- When the tires are very worn

⚠ WARNING

- When a tire chains, compact spare tire or an emergency tire puncture repair kit is used







- **Precautions for the suspension**

Do not modify the suspension of the vehicle. If the height or tilt of the vehicle is changed, the sensors may not be able to detect detectable objects and the system may not operate correctly, possibly leading to an accident.

Enabling/Disabling the Parking Support Brake



The Parking Support Brake can be enabled/disabled on the multi-information display. All of the Parking Support Brake functions (static objects front and rear of the vehicle, moving vehicles rear of the vehicle, pedestrians rear of the vehicle and static objects around the vehicle) are enabled/disabled simultaneously.

Use the meter control switches to enable/disable the parking support brake. (→P.156)

- 1 Press  or  to select .
- 2 Press  or  to select “ PKSB” and then press OK.

When the Parking Support Brake is disabled, the driving assist information indicator (→P.149) illuminates.

To re-enable the system when it

was disabled, select  on the multi-information display, select “ PKSB” and then On. If disabled using this method, the system will not be re-enabled by turning the power switch off and then to ON.

Display and buzzer for EV system output restriction control and brake control

If the EV system output restriction control or brake control operates, a buzzer will sound and a message will be displayed on the multi-information display and multimedia system screen, to alert the driver.

Depending on the situation, EV system output restriction control will operate to either limit acceleration or restrict output as much as possible.

- EV system output restriction control is operating (acceleration restriction)

Acceleration greater than a certain amount is restricted by the system.

Multimedia display: No warning displayed

Multi-information display: “Object Detected Acceleration Reduced”

Driving assist information indicator: Not illuminated

Buzzer: Does not sound

- EV system output restriction control is operating (output restricted as much as possible)

The system has determined that

stronger-than-normal brake operation is necessary.

Multimedia display: "BRAKE!"

Multi-information display: "BRAKE!"

Driving assist information indicator:
Not illuminated

Buzzer: Short beep

● Brake control is operating

The system determined that emergency braking is necessary.

Multimedia display: "BRAKE!"

Multi-information display: "BRAKE!"

Driving assist information indicator:
Not illuminated

Buzzer: Short beep

● Vehicle stopped by system operation

The vehicle has been stopped by brake control operation.

Multimedia display: "Press Brake Pedal"

Multi-information display: "Accelerator Pedal is Pressed Press Brake Pedal" (If the accelerator pedal is not depressed, "Press Brake Pedal" will be displayed.)

Driving assist information indicator:
Illuminated

Buzzer: Sounds repeatedly

System overview

If the Parking Support Brake determines that a collision with a detected object or pedestrian is possible, the EV system output will be restricted to restrain any increase in the vehicle speed.

(EV system output restriction control: See figure 2.)

Additionally, if the accelerator pedal continues to be depressed, the brakes will be applied automatically to reduce the vehicle speed. (Brake control: See figure 3.)

● Figure 1 When the PKSB (Parking Support Brake) is not operating

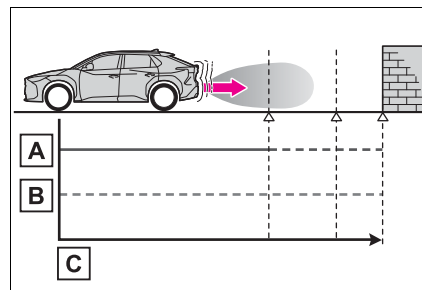

A EV system output

B Braking force

C Time

● Figure 2 When EV system output restriction control operates

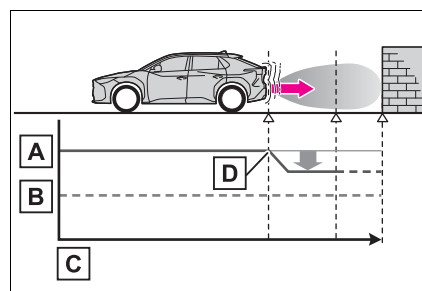

A EV system output

B Braking force

- C** Time
- D** EV system output restriction control begins operating (System determines that possibility of collision with detected object is high)
- Figure 3 When EV system output restriction control and brake control operates

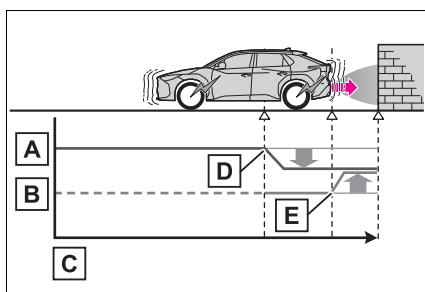

- A** EV system output
- B** Braking force
- C** Time
- D** EV system output restriction control begins operating (System determines that possibility of collision with detected object is high)
- E** Brake control begins operating (System determines that possibility of collision with detected object is extremely high)

■ **If the Parking Support Brake has operated**

If the vehicle is stopped due to operation of the Parking Support Brake, the Parking Support Brake will be disabled and the driving assist infor-

mation indicator will illuminate. If the Parking Support Brake operates unnecessarily, brake control can be canceled by depressing the brake pedal or waiting for approximately 2 seconds for it to automatically be canceled. Then, the vehicle can be operated by depressing the accelerator pedal.

■ **Re-enabling the Parking Support Brake**

To re-enable the Parking Support Brake when it has been disabled due to operation of the Parking Support Brake, either enable the system again (→P.333), or turn the power switch off and then back to ON.

Additionally, if any of the following conditions are met, the system will be re-enabled automatically and the driving assist information indicator will turn off:

- The P shift position is selected
- The object is no longer detected in the traveling direction of the vehicle
- The traveling direction of the vehicle changes*

*: Except when the pedestrian rear of the vehicle operated.

■ **Intuitive parking assist-sensor buzzer**

Regardless of whether the intuitive parking assist-sensor buzzer is enabled or not, if the PKSB (Parking Support Brake) system is enabled, the front or rear sensors detect a static object and brake control is performed, the intuitive parking assist-sensor buzzer will sound to notify the driver of the approximate distance to the object.

■ **If a 12-volt battery terminal has been disconnected and reconnected**

The system needs to be initialized. To initialize the system, drive the vehicle straight ahead for 5 seconds or more at a speed of approximately

22 mph (35 km/h) or more.

Static Objects Front and Rear of the Vehicle^{*}

^{*}: If equipped

If the sensors detect a static object, such as a wall, in the traveling direction of the vehicle and the system determines that a collision may occur due to the vehicle suddenly moving forward due to an accidental accelerator pedal operation, the vehicle moving the unintended direction due to the wrong shift position being selected, or while parking or traveling at low speeds, the system will operate to lessen the impact with the detected static object and reduce the resulting damage.

Examples of function operation

This function will operate in situations such as the following if an object is detected in the traveling direction of the vehicle.

- When traveling at a low speed and the brake pedal is not depressed, or is depressed late

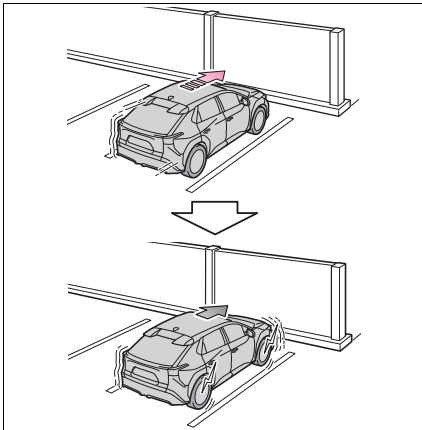

- When the vehicle moves in the unintended direction due to the wrong shift position being selected

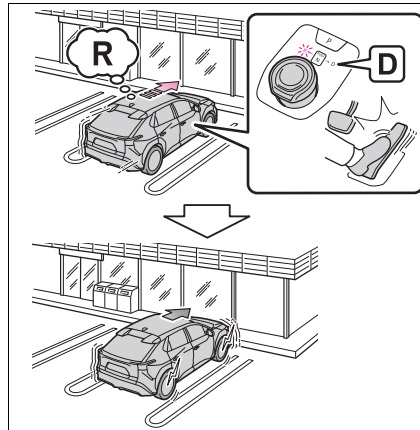

- When the accelerator pedal is depressed excessively

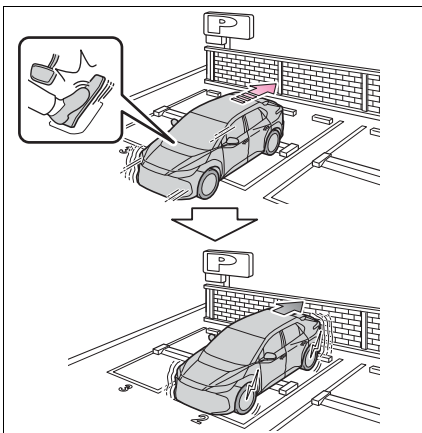

Types of sensors

→P.311

⚠ WARNING

- To ensure the system can operate properly
→P.312
- If the PKSB (Parking Support Brake) system operates unnecessarily, such as at a railroad crossing
→P.335
- Notes when washing the vehicle
→P.313

- The system will operate when

The function will operate when the driving assist information indicator is not illuminated (→P.149, 517) and all of the following conditions are met:

- EV system output restriction con-

- trol
- The Parking Support Brake is enabled.
- The vehicle speed is approximately 9 mph (15 km/h) or less.
- There is a static object in the traveling direction of the vehicle and approximately 6 to 13 ft. (2 to 4 m) away.
- The Parking Support Brake determines that a stronger-than-normal brake operation is necessary to avoid a collision.
- Brake control
- EV system output restriction control is operating.
- The Parking Support Brake determines that an immediate brake operation is necessary to avoid a collision.

■ The system will stop operating when

The function will stop operating if any of the following conditions are met:

- EV system output restriction control
- The Parking Support Brake is disabled.
- The system determines that the collision has become avoidable with normal brake operation.
- The static object is no longer approximately 6 to 13 ft. (2 to 4 m) away from the vehicle or in the traveling direction of the vehicle.
- Brake control
- The Parking Support Brake is disabled.
- Approximately 2 seconds have elapsed since the vehicle was stopped by brake control.
- The brake pedal is depressed after the vehicle is stopped by brake control.
- The static object is no longer approximately 6 to 13 ft. (2 to 4 m) away from the vehicle or in the traveling direction of the vehicle.

■ Detection range

The detection range of the system

differs from the detection range of the intuitive parking assist-sensor. (→P.316)

Therefore, even if the intuitive parking assist-sensor detects a static object and provides a warning, the PKSB (Parking Support Brake) system may not start operating.

■ Situations in which the system may not operate properly

→P.314

■ Situations in which the system may operate even if there is no possibility of a collision

→P.315

Moving Vehicle Rear of the Vehicle*

*: If equipped

If a rear radar sensor detects a vehicle approaching from the right or left at the rear of the vehicle and the system determines that the possibility of a collision is high, this function will perform brake control to reduce the likelihood of an impact with the approaching vehicle.

Examples of function operation

This function will operate in situations such as the following if a vehicle is detected in the traveling direction of the vehicle.

- **When reversing, a vehicle is approaching and the brake pedal is not depressed, or is depressed late**

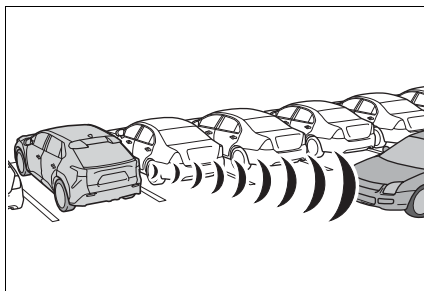

Types of sensors

→P.303

⚠ WARNING

■ **To ensure the system can operate properly**
→P.303

■ **The system will operate when**

The function will operate when the driving assist information indicator is not illuminated (→P.149, 517) and all of the following conditions are met:

- EV system output restriction control
- The Parking Support Brake is enabled.
- The vehicle speed is approximately 9 mph (15 km/h) or less.
- Vehicles are approaching from the right or left at the rear of the vehicle at a traveling speed of approximately 5 mph (8 km/h) or more.
- The shift position is in R.
- The Parking Support Brake determines that a stronger than normal brake operation is necessary to avoid a collision with an approaching vehicle.
- Brake control
- EV system output restriction control is operating.
- The Parking Support Brake determines that an emergency brake operation is necessary to avoid a collision with an approaching vehicle.

■ **The system will stop operating when**

The function will stop operating if any of the following conditions are met:

- EV system output restriction control
- The Parking Support Brake is disabled.
- The collision becomes avoidable with normal brake operation.
- A vehicle is no longer approaching from the right or left at the rear of the vehicle.

- Brake control
- The Parking Support Brake is disabled.
- Approximately 2 seconds have elapsed since the vehicle was stopped by brake control.
- The brake pedal is depressed after the vehicle is stopped by brake control.
- A vehicle is no longer approaching from the right or left at the rear of the vehicle.

■ Detection range

The detection area of the moving vehicles rear of the vehicle differs from the detection area of the RCTA function (→P.324). Therefore, even if the RCTA function detects a vehicle and provides an alert, the moving vehicles rear of the vehicle may not start operating.

■ RCTA buzzer

Regardless of whether the RCTA function is on or off, if the PKSB (Parking Support Brake) system is not disabled, when the brake control operates, the buzzer will sound to alert the driver.

■ Situations in which the system may not operate properly

→P.325

■ Situations in which the system may operate even if there is no possibility of a collision

→P.326

Pedestrians Rear of the Vehicle*

*: If equipped

If the rear camera sensor detects a pedestrian behind the vehicle while backing up and the system determines that the possibility of colliding with the detected pedestrian is high, a buzzer will sound. If the system determines that the possibility of colliding with the detected pedestrian is extremely high, the brakes will be applied automatically to help reduce the impact of the collision.

Examples of system operation

When a pedestrian is detected behind the vehicle while backing up, the brake pedal is not depressed or is depressed late.

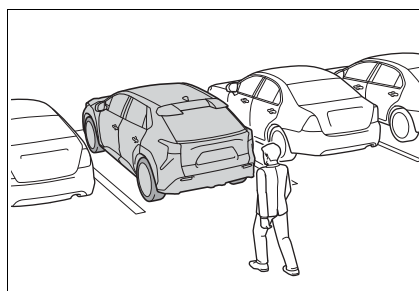

Multimedia display

Displays a message to urge the

driver to take evasive action when a pedestrian is detected in the detection area behind the vehicle. (A message will also be displayed on the multi-information display.)

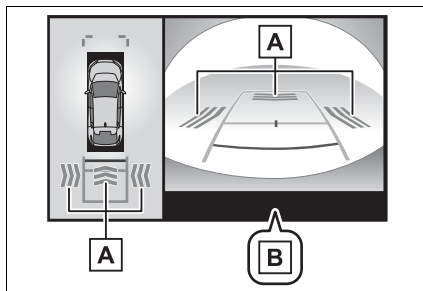

A Pedestrian detection icon

B "BRAKE!"

! WARNING

■ If the PKSB (Parking Support Brake) system operates unnecessarily

Depress the brake pedal immediately after the PKSB (Parking Support Brake) system operates. (Operation of the function is canceled by depressing the brake pedal.)

■ Correct use of the PKSB (Parking Support Brake) system

→P.328

■ The system will operate when

The function will operate when the driving assist information indicator is not illuminated (→P.149, 517) and all of the following conditions are met:

- EV system output restriction control
- The Parking Support Brake is enabled.

- The vehicle speed is 9 mph (15 km/h) or less.
- The shift position is in R.
- The rear camera sensor detects a pedestrian behind the vehicle while backing up and the system determines that the possibility of colliding with the detected pedestrian is high.
- When a pedestrian is detected behind the vehicle.
- The Parking Support Brake determines that a stronger-than-normal brake operation is necessary to avoid a collision.

- Brake control
- EV system output restriction control is operating.
- The Parking Support Brake determines that an emergency brake operation is necessary to avoid a collision with a pedestrians.

■ The system will stop operating when

The function will stop operating if any of the following conditions are met:

- EV system output restriction control
- The Parking Support Brake is disabled.
- The collision becomes avoidable with normal brake operation.
- The pedestrian is no longer detected behind your vehicle.
- Brake control
- The Parking Support Brake is disabled.
- Approximately 2 seconds have elapsed since the vehicle was stopped by brake control.
- The brake pedal is depressed after the vehicle is stopped by brake control.
- The pedestrian is no longer detected behind your vehicle.

■ Re-enabling the pedestrians rear of the vehicle

→P.335

■ Detection range

The detection area of the pedestrians rear of the vehicle differs from the detection area of the RCD function (→P.329). Therefore, even if the RCD function detects a pedestrian and provides an alert, the pedestrians rear of the vehicle may not start operating.

■ Situations in which the system may not operate properly

→P.330

■ Situations in which the system may operate unexpectedly

→P.330

Static Objects Around the Vehicle (vehicles with Advanced Park)

While parking, if a sensor detects a surrounding stationary object, such as a wall, with which a collision is likely, the system will operate to help avoid a collision or reduce the impact of the collision.

Examples of function operation

The system will operate in the following situations when a stationary object is detected in the surrounding area.

■ When moving forward and a collision with a stationary object on the inner side of a turn is likely

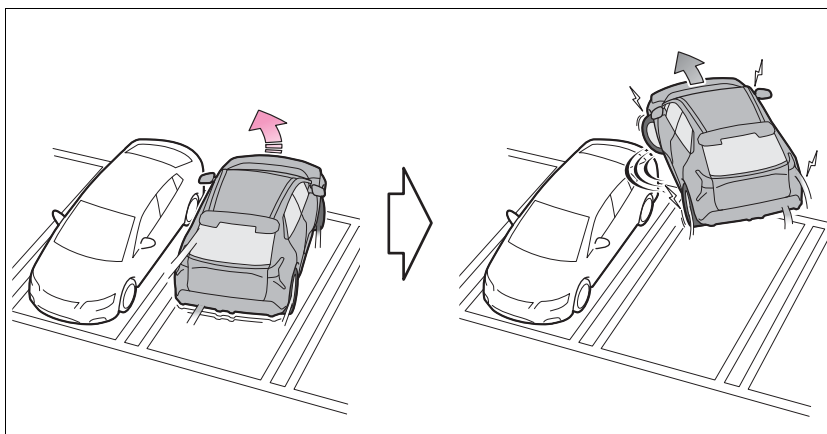

■ **When reversing and a collision with a stationary object on the outer side of a turn is likely**

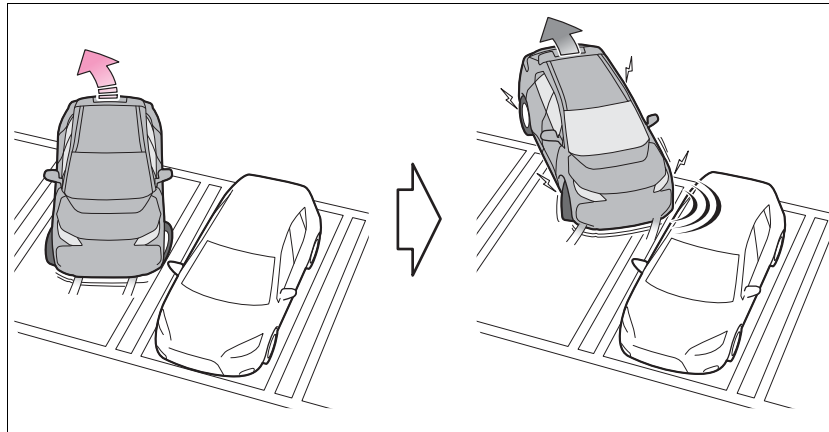

■ **Operating conditions**

This function is operable when any of the operating conditions are met in addition to the following conditions for stationary objects in around the vehicle.

- After the EV system has been started, the vehicle has moved approximately 23.0 ft. (7 m) or less
- The R shift position is selected
- After the shift position has been changed from R to D, the vehicle has moved approximately 23.0 ft. (7 m) or less

■ **The system will stop operating when**

→P.338

■ **Sensor detection information**

The detection range of the system differs from the detection range of the intuitive parking assist-sensor. Therefore, even if the intuitive parking assist-sensor detects a static object and provides a warning, the PKSB (Parking Support Brake) system may not start operating.

■ **Objects which the sensor may not be properly detected**

→P.314

■ **Situations in which the system may operate even though there is no possibility of a collision**

In addition to the situations in which stationary objects around the vehicle (→P.337) may not be detected, objects may not be detected by the sensors in the following situations

When moving sideways, such as when parallel parking: →P.338

■ **Detection of objects along the sides of the vehicle**

- Objects along the sides of the vehicle are not instantaneously detected. The location of objects in relation to the vehicle is estimated after they are first detected by the front or rear side sensors, or side cameras. Therefore, after the power switch is changed to ON, even if an object is along the side of the vehicle, it may not be detected until the vehicle has been driven a small amount and the side sensors or side cameras completely scan the areas along the sides of the vehicle.
- If a vehicle, person, animal, etc, is

detected by a side sensors or side cameras, but then leaves the detection area of the side sensors or side cameras, the system will assume the object has not moved.

Toyota Teammate Advanced Park*

*: If equipped

Purpose of the Advanced Park

The Advanced Park is a system which assists in safely and smoothly parking in a target parking space by displaying the blind spots around the vehicle and the parking spot through a bird's eye view, delivering operation guidance through displays and buzzer operation, and changing the shift position, operating the steering wheel, accelerator pedal, and brake pedal.

Additionally, the panoramic view monitor can display the area in front, behind, and from above the vehicle, helping confirm the condition of the area around the vehicle.

For details on the panoramic view monitor refer to "MULTIMEDIA OWNER'S MANUAL".

Depending on the condition of the road surface or the vehicle, the distance between the vehicle and a parking space, etc., it may not be possible to assist in parking in the target space.

■ Preparation before using

→P.375

Purpose of the Remote control function

Remote control function is a system which assists in parking or exiting from a parking space selected on the multimedia display by allowing changing the shift position, operating the steering wheel, accelerator pedal, and brake pedal from outside of the vehicle via a smartphone.

Advanced Park Functions**■ Perpendicular parking (forward/reverse) function**

Assistance is provided from the position the vehicle is stopped near the target parking space until the vehicle is in the parking space. (→P.356)

■ Perpendicular exiting (forward/reverse) function

Assistance is provided from the parked position until the vehicle is in a position where you can easily exit from the parking space. (→P.359)

■ Parallel parking function

Assistance is provided from the position the vehicle is stopped near the target parking space until the vehicle is in the parking space. (→P.360)

■ Parallel exiting function

Assistance is provided from the

parked position until the vehicle is in a position where you can easily exit from the parking space. (→P.364)

■ Memory function

Assistance is provided until the vehicle is guided into a previously registered parking space. (→P.366)

■ Remote control function

By operating a smartphone, assistance in entering or exiting a nearby target parking space, confirmed on the screen of the smartphone, is provided from outside of the vehicle. (→P.371)

⚠ WARNING**■ Cautions regarding the use of the system**

The recognition and control capabilities for this system are limited. Do not overly rely on this system. The driver is always responsible for paying attention to the vehicle's surroundings and driving safely.

- As with a normal vehicle, take care to observe your surroundings while the vehicle is moving.
- Always pay attention to the vehicle's surroundings while the system is operating and depress the brake pedal as necessary to slow or stop the vehicle.
- When parking, make sure that the vehicle can be parked in the target parking space before beginning operation.

 **WARNING**

- Depending on the condition of the road surface or the vehicle, the distance between the vehicle and a parking space, etc., it may not be possible to detect a parking space or the system may not be able to provide assistance to the point the vehicle is fully parked.
- This system will guide the vehicle to appropriate positions for changing the direction of travel, however, if you feel that the vehicle is approaching too close to an adjacent parked vehicle at any time, depress the brake pedal and change the shift position. However, if this is performed, the number of times the vehicle changes direction may increase, and the vehicle may be parked at an angle.
- As following objects may not be detected, make sure to check the safety of the area around your vehicle and depress the brake pedal to stop the vehicle if it may collide with an object.
 - Thin objects such as wire, fences, rope, etc.
 - Cotton, snow and other materials that absorb sound waves
 - Sharply-angled objects
 - Low objects (curb stones, parking blocks, etc.)
 - Tall objects with upper sections that protrude outward
- Even if there is an object in the target parking space, it may not be detected and assistance may be performed.
- While the system is operating, if it is likely that your vehicle will collide with a nearby vehicle, parking block, object, or person, depress the brake pedal to stop the vehicle and press the Advanced Park main switch to disable the system.
- Never use only the multimedia display to view the area behind the vehicle. The image displayed may differ than the actual situation. Using only the screen when backing up may lead to an accident, such as a collision with another vehicle. When backing up, make sure to look directly or use the mirrors to check the safety of the area around your vehicle, especially behind the vehicle.
- When the ambient temperature is extremely low, the screen may appear dark or the displayed image may become unclear. Also, as moving objects may appear distorted or may not be able to be seen on the screen, make sure to directly check the safety of the area around your vehicle. In the following situations, while the vehicle is stopped and held by Advanced Park, it may be canceled and the vehicle may start moving. Immediately depress the brake pedal. Failure to do so may lead to an accident.
 - When the driver's door is opened
 - When operations instructed by the system are not performed within a certain amount of time
 - When the brake pedal is depressed and the vehicle is stopped for a certain amount of time

⚠ WARNING

- When the system malfunctions
- As the steering wheel will turn while this system is operating, pay attention to the following.
- Be careful so that a necktie, scarf, or arm does not get caught. Keep your upper body away from the steering wheel. Also, keep children away from the steering wheel.
- Long fingernails may be caught and when the steering wheel is rotating, leading to injury.
- In an emergency, depress the brake pedal to stop the vehicle, and then press the Advanced Park main switch to disable the system.
- Do not allow anyone to put their hands outside of a window while this system is operating.
- **Precautions for the cameras and sensors**
- Due to the characteristics of the camera lens, the position of and distance to people and objects displayed on the screen may differ from the actual situation. For details on the following, refer to “Panoramic view monitor” of “Peripheral monitoring system” in the “MULTIMEDIA OWNER’S MANUAL”.
- Make sure to observe the precautions for using the intuitive parking assist-sensor (→P.312), otherwise a sensor may not operate correctly, possibly leading to an accident.
- In situations such as the following, the sensors may not operate correctly, possibly leading to an accident. Proceed carefully.

- When there is a parked vehicle next to the target parking space, if the displayed target parking space is far from the actual target parking space, a sensor may be misaligned. Have the vehicle inspected by your Toyota dealer.
- Do not install any accessories near the detection area of the sensors.

■ **To ensure correct operation of the Advanced Park**

Observe the following precautions.

Failing to do so may result in the vehicle being unable to be driven safely and possibly leading to an accident.

- Do not use this system in situations such as the following:
- When in areas other than common parking spaces
- When the surface of the parking space is sand or gravel and is not clearly defined with parking space lines
- When the parking space is not level, such as when on a slope or has differences in height
- Mechanical parking system
- Parking lot with a device which raises to contact the bottom of the vehicle
- When the road surface is frozen, slick, or covered with snow
- When it is extremely hot and the asphalt is melting
- When there is an object in front of the vehicle

 **WARNING**

- When there is an object between your vehicle and the target parking spot or within the target parking spot (within the displayed blue box)
- When there is a gutter between your vehicle and the target parking space or within the target parking spot (within the displayed blue box)
- When there is a hole or gutter in the exit direction
- When in high pedestrian or vehicle traffic areas
- When the parking space is in a location that is difficult to park in (too narrow for your vehicle, etc.)
- When images are unclear due to dirt or snow attached to the camera lens, light being shined into the camera or shadows
- When tire chains or a compact spare tire is installed to the vehicle
- When the doors are not completely closed
- When an arm is held outside of a window
- In inclement weather such as heavy rain or snow
- Make sure to use only standard sized tires, such as those that were installed to the vehicle when it was shipped from the factory. Otherwise, Advanced Park may not operate properly. Also, when the tires have been replaced, the displayed position of the lines or box displayed on the screen may become incorrect. When replacing the tires, contact by your Toyota dealer.

- In situations such as the following, it may not be possible for the system to provide assistance to a registered parking spot:
 - When the tires are extremely worn or the tire inflation pressure is low
 - When carrying a heavy load
 - When the vehicle is tilted due to the carried load
 - When a heater is installed in the surface of the parking space (road surface freeze prevention heater)
 - When the wheels are misaligned, such as after a wheel has been subject to a strong impact
 - When a pedestrian or passing vehicle is detected during assistance
 - When something is incorrectly detected as a parking line (light, reflections from a building, difference in height on the parking surface, a gutter, painted road lines, redrawn lines, etc.)

If the vehicle deviates greatly from the set parking space in any situation other than the above, have the vehicle inspected at your Toyota dealer as soon as possible.

■ **When using Remote control function**

- Remote control function is a function of the Advanced Park system. When using Remote control function on public roads, be sure to follow all local road traffic laws and regulations.
- Remote control function can only be used after agreeing to the disclaimer of the smart-phone application.

⚠ WARNING

- Remote control function can only perform some driving operations. It should only be operated by a driver with a valid driving license. While using application, carry, electronic key. While operating, do not stare at the application screen, and pay attention to the vehicle's surroundings. In an emergency, cancel the Remote control function operation and stop the vehicle.
- As with a normal vehicle, take care to observe the area around the vehicle while the vehicle is moving.
- Always pay attention to the vehicle's surroundings while the system is operating.
- Remote control function is a system which assists in remote parking or exiting operations using a smartphone. When using Remote control function, the driver must carry the electronic key and smartphone and confirm the safety of the area around the vehicle.
- While using Remote control function, the vehicle can be stopped by stop continuously operating the smartphone (stopping movement of your finger, removing your finger from the screen, etc.). The vehicle can also be stopped by touching the cancel button on the smartphone application, unlocking the doors using the electronic key, or opening a door.
- If it seems like your vehicle may contact an obstruction, etc., stop operating the smartphone and cancel Remote control function if necessary.
- System operation will only be performed at a fixed speed and the vehicle cannot be accelerated or decelerated even if the speed of continuous operation of the smartphone is increased or decreased.
- Never drive the vehicle while staring at the smartphone screen.
- When driving, make sure to directly check the safety of the area around your vehicle.
- Do not use Remote control function when passengers or pets are in the vehicle.
- In an emergency, the system can be canceled by operating a switch on the electronic key or by opening a door.
- To use Remote control function, it is necessary to have a smartphone with the latest version of the Remote Park app. The following operating systems are supported:
 - Android™
 - Apple® iOS
- When registering the vehicle to the Remote Park smartphone app, disconnect any other apps which are connected to the vehicle.
- To enable Remote control function, make sure to disable the Apple CarPlay connection.
- When parking, make sure that the vehicle can be parked in the target parking space before beginning operation.

 **WARNING**

- Only use Remote control function on level road surfaces which are not slick. Do not use Remote control function for parking spaces on a downward or upward incline.
- While Remote control function is operating, if a malfunction or system limitation is detected, the following will occur automatically:
 - Remote control function will be canceled
 - The vehicle will stop
 - The shift position will change to P and the parking brake will be engaged
 - The power switch will turn off (for some malfunctions, the power switch will not turn off or cannot be turned off. Enter the vehicle and take corrective action according to the message displayed on the smartphone.)
 - The doors will remain locked
- When starting Remote control function, unlock the doors with wireless remote control by electronic key.
- When Remote control function is operating, the driver should remain within approximately 9.8 ft. (3 m) of the vehicle. If the driver becomes more than approximately 9.8 ft. (3 m) away, Remote control function will be suspended and a message will be displayed on the smartphone. Remote control function operation can be resumed by approaching the vehicle.

- The headlights will be turned on if the surrounding area is dark.
- If system operation is canceled due to a malfunction, the emergency flashers will flash. The emergency flashers will turn off if any of the following conditions are met:
 - A door is opened
 - 3 minutes have elapsed since the emergency flashers began flashing
- Remote control function can only be started when the following conditions are met:
 - When the EV system is starting, after assist mode is selected
 - When the power switch is off
 - When the remote air conditioning is operating
- After unlocking the doors using the wireless remote control, if the doors are locked using the smart entry function, the lock operation may be delayed.

 **NOTICE**

■ **Precautions for use Advanced Park**

If the 12-volt battery was discharged or has been removed and installed, fold and extend the outside rear view mirrors.

■ **When using Remote control function**



NOTICE

- Check the battery charge level of the smartphone before using Remote control function. If the battery of the smartphone dies while operating Remote control function, assist will be suspended. Also, if the battery charge level of the smartphone is 20% or less when attempting to start Remote control function, Remote control function will not be started.
- Turn on the Bluetooth communication function of the smartphone before using Remote control function. Remote control function cannot be used if the Bluetooth function is off.
- Do not turn off the Bluetooth function of the smartphone or disconnect from the multimedia system while using Remote control function. If the vehicle cannot be connected to via Bluetooth, Remote control function cannot be used.
- While using Remote control function, if a call is received, etc., and another app is opened, Remote control function will be suspended. Assist can be resumed if the Remote Park app is reopened within 3 minutes. If 3 minutes or more elapse, assist will be canceled.
- While using Remote control function, if the home button or power button of the smartphone is pressed and the screen is locked, Remote control function will be suspended. Assist can be resumed if the Remote Park app is reopened within 3 minutes. If 3 minutes or more elapse, assist will be canceled.
- Do not use the Remote Park app with devices other than those which operation has been confirmed by the maker. Otherwise the system may not operate correctly.
- When the ambient temperature is low, it may take time for the system to start, due to 12-volt battery charging.
- If the 12-volt battery voltage drops, assistance will be canceled.
- When using Remote control function on a slope, the vehicle speed will be slower and the distance that the vehicle will approach objects will become longer than when on a level road surface.
- If a system temporary failure occurs, after the vehicle is stopped by the electronic parking brake or the shift position being changed to P, the power switch may turn off and the system may be canceled. In this case, have the vehicle inspected by your Toyota dealer.
- If a system malfunction occurs, assistance may be temporarily suspended. If the system returns to normal, operation can be resumed. Follow the content on the smartphone screen to resume operation.
- Remote control function cannot be started if the EV system has been started using an aftermarket remote starter.

 NOTICE

- After Remote control function completes, the parking brake will be engaged as per regulations. As the parking brake may freeze and not be able to be released, avoid using Remote control function in extremely cold areas. Also, if the parking brake freezes, it may make a noise when it is released. However, this does not indicate a malfunction.
- Do not use the remote function with an electronic key that has a depleted battery.
- The remote function cannot be started while the vehicle charging connector is connected. If support is accidentally started, it may end abnormally.

Type of Advanced Park cameras and sensors

Cameras and sensors are used to detect parked vehicles, making it easier to identify parking spaces.

▶ Front camera

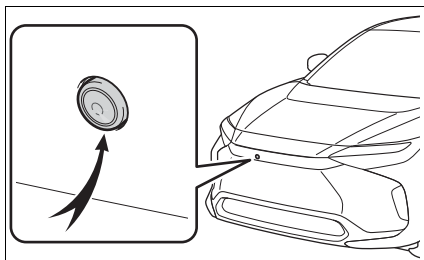

▶ Side cameras

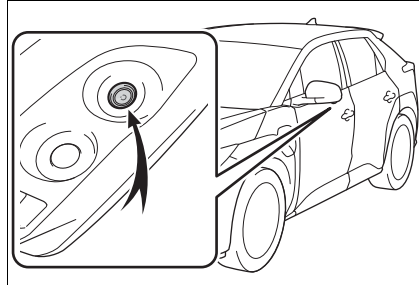

▶ Rear camera

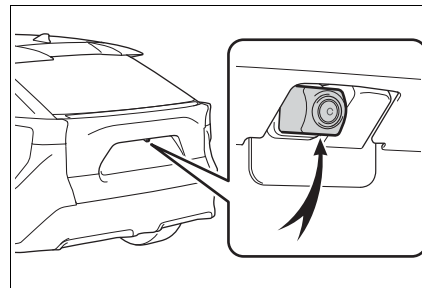

▶ Sensors

→P.311

■ Camera images

As special cameras are used, the colors in displayed images may differ from the actual color.

■ Precautions for use

For details on the following, refer to "MULTIMEDIA OWNER'S MANUAL".

- Displayable range of the screens
- Cameras
- Differences between displayed images and the actual road
- Differences between displayed images and the actual objects

■ Detection range of the cameras and sensors

- If a parked vehicle is behind the target parking space and the distance between it and the vehicle

becomes far, it may no longer be able to be detected. Depending on shape or condition of a parked vehicle, the detection range may become short or the vehicle may not be detected.

- Objects other than parked vehicles, such as columns, walls, etc., may not be detected. Also, if they are detected, they may cause the target parking space to be misaligned.

■ **Situations in which white parking space lines may not be recognized properly**

- In situations such as the following, parking space lines on the road surface may not be detected:
 - When the parking space does not use white lines (parking space boundaries are marked with rope, blocks, etc.)
 - When the parking space lines are faded or dirty, making them unclear
 - When the road surface is bright, such as concrete, and the contrast between it and the white parking space lines is small
 - When the parking space lines are any color other than yellow or white
 - When the area surrounding the parking space is dark, such as at night, in an underground parking lot, parking garage, etc.
 - When it is raining or has rained and the road surface is wet and reflective or there are puddles
 - When the sun is shining directly into a camera, such as in the early morning or evening
 - When the parking space is covered with snow or de-icing agent
 - When there marks from repairs or other marks on the road surface, or there is a traffic bollard, or other object on the road surface
 - When the color or brightness of the road surface is uneven
 - When a camera has been splashed by hot or cold water and the lens has fogged up

- When the appearance of the parking space is affected by the shadow of the vehicle or trees
- When a camera lens is dirty or covered with water droplets
- In situations such as the following, the target parking space may not be recognized correctly:
 - When there marks from repairs or other marks on the road surface, or there is a parking block, traffic bollard, or other object on the road surface
 - When it is raining or has rained and the road surface is wet and reflective or there are puddles
 - When the area around the vehicle is dark or backlit
 - When the color or brightness of the road surface is uneven
 - When the parking space is on a slope
 - When there are diagonal lines (access aisle) near the parking space
 - When the appearance of the parking space is affected by the shadow of a parked vehicle (such as shadows from the grille, side step, etc.)
 - When accessories which obstruct the view of the camera are installed
 - When the parking space lines are faded or dirty, making them unclear
 - When the appearance of the parking space is affected by the shadow of the vehicle or trees

■ **Sensor detection information**

→P.313

■ **Objects which the sensor may not be properly detected**

→P.314

■ **Situations in which the sensor may not operate properly**

→P.314

■ **Situations in which parking assistance may not operate even if there is no possibility of a collision**

→P.315

Turning the Advanced Park on/off

Press the Advanced Park main switch.

If the switch is pressed while assistance is being performed, the assistance will be canceled.

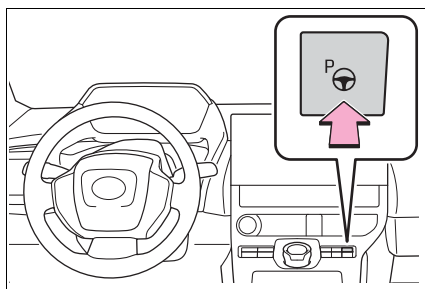

■ **Operating conditions of the Advanced Park**

Assistance will begin when all of the following conditions are met:

- The brake pedal is depressed
- The vehicle is stopped
- The driver's seat belt is fastened
- The steering wheel is not being operated
- The accelerator pedal is not depressed
- All of the doors are closed
- The outside rear view mirrors are not folded
- The parking brake is not engaged
- The dynamic radar cruise control are not operating
- ABS, VSC, TRAC, PCS and PKSB are not operating

- The vehicle is not on a steep slope
- The VSC and TRAC are not turned off

If assistance cannot be started, check the message displayed on the multimedia display (→P.380)

Advanced Park guidance screens

Guidance screens are displayed on the multimedia display.

- ▶ Guidance screen (When assistance starts)

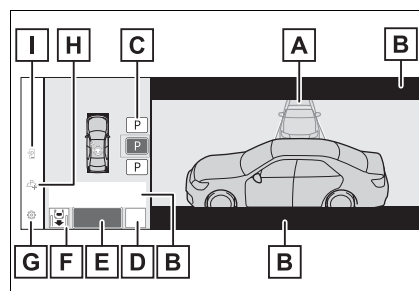

A Target parking space box (blue)

B Advice display

C Parking type change button

If multiple switches are displayed, depending on the condition of the switch its function differs as follows.

P or **P** : Change the target to another parking space.

P or **P** Change the target to another parking space.

(P) : Select to change to the par-

allel parking function



: Change the perpendicular parking (forward/reverse) function

D “MODE” button

Select to change between the memory function and the perpendicular parking (forward/reverse) function and parallel parking function. (→P.368)

E “Start” button

Select to start parking assistance.

F Perpendicular parking direction change button

Select to change between the parking (forward) function and parking (reverse) function



: Change the perpendicular parking (forward) function



: Change the perpendicular parking (reverse) function

G Customize setting button

Select to display the Advanced Park setting screen. (→P.379)

H Registration button

Select to begin registering a parking space.

I Remote control function start button

Select to start parking assistance operation on the smartphone display.

► Guidance screen (When reversing)

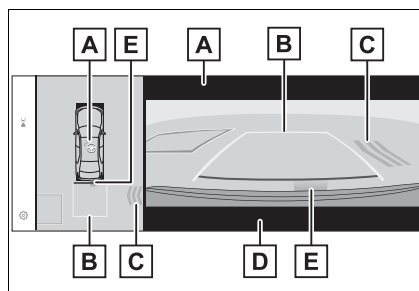

A Operation icon

Displayed when the Advanced Park is operating.

B Guide lines (yellow and red)

Display points from the center of the edge of the front or rear bumper to the target stopping position (yellow)* and approximately 1 ft. (0.3 m) (red) from the vehicle.

C Moving object warning icon

D Emergency support brake control operation display
“BRAKE!” is displayed.

E Intuitive parking assist-sensor display

→P.312

*: When the target stop position is 8.2 ft. (2.5 m) or more, the horizontal line (yellow) will be hidden.

■ Intuitive parking assist-sensor pop-up display

Regardless of whether the intuitive parking assist-sensor is off or on (→P.312), if an object is detected by the intuitive parking assist-sensor when the Advanced Park is operating, the intuitive parking assist-sensor pop up display will automatically

be displayed over the guidance display.

■ **Brake control operation when Advanced Park is operating**

While the Advanced Park is operating, if the system determines that the possibility of collision with detected moving or stationary object is high, the EV system output restriction control and brake control will operate.

If brake control operates, Advanced Park operation will be suspended and a message will be displayed on the multi-information display.

■ **Buzzer**

Depending on surrounding sounds or sounds from other systems, it may be difficult to hear the buzzer of this system.

■ **If a black screen is displayed on the multimedia display when the Advanced Park is operating**

The system is being affected by radio waves or may be malfunctioning. If a radio antenna is installed near a camera, move it to a location as far from the cameras as possible. If a radio antenna is not installed near a camera, and the screen does not return to normal after turning the power switch off and then starting the EV system again, have the vehicle inspected by your Toyota dealer.

Advanced Park Perpendicular parking (forward/reverse) function

■ **Function description**

The perpendicular parking (forward/reverse) function can be used if the target parking space can be detected when the vehicle is stopped close and perpendicular to the center of the

parking space. Also, depending on the condition of the parking space, etc., if it is necessary to change the direction of travel of the vehicle, the shift position can be changed by assistance control.

■ **Parking using the perpendicular parking (forward/reverse) function**

- 1 Stop the vehicle at a position close and perpendicular to the center of the target parking space.
 - ▶ If there are parking space lines

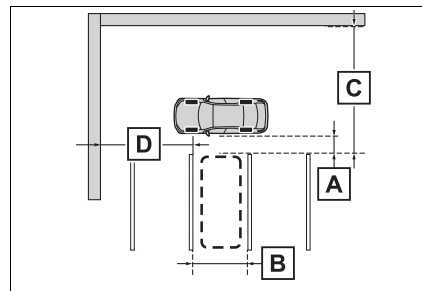

- A] Approximately 3.3 ft. (1 m)*
- B] Approximately 8.2 ft. (2.5 m)*
- C] Approximately 19.7 ft. (6 m) or more*
- D] Approximately 18.0 ft. (5.5 m) or more*

The system can operate even if there is a parking space line on only one side of the target parking space.

*: This is a reference measurement for detection of a parking space.

Depending on the surrounding environment, detection may not be possible.

- ▶ If there is an adjacent parked vehicle

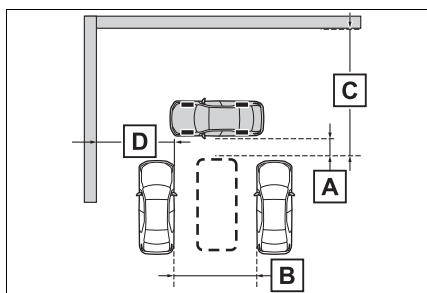

- A** Approximately 3.3 ft. (1 m)*
- B** Approximately 9.8 ft. (3 m) or more*
- C** Approximately 19.7 ft. (6 m) or more*
- D** Approximately 18.0 ft. (5.5 m) or more*

The system can operate even if there is a vehicle on only one side of the target parking space.

*: This is a reference measurement for detection of a parking space. Depending on the surrounding environment, detection may not be possible.

- 2 Press the Advanced Park main switch and check that a possible parking space is dis-

played on the multimedia display.

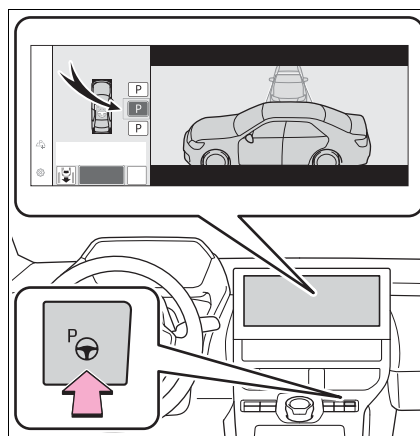

- If a space which your vehicle can be parked is detected, a target parking space box will be displayed.
- If it is possible to parallel park in the space, select the parking space, and then select **(P)** to change to the parallel parking function.
- If it is possible to change the direction which a parking space is entered, select the parking space, and then select or change the direction.
- Depending on the surrounding environment, it may not be possible to use this function. According to the information displayed on the multimedia display, use the function on another parking space.

3 Select “Start” button.

A buzzer will sound, an operation message will be displayed on the multi-information display, and assistance will begin operating.

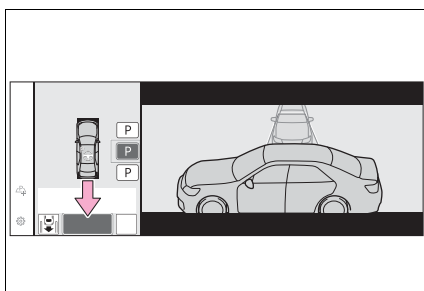

- When the brake pedal is released, “Moving Forward...”, “Backing Up...” will be displayed and the vehicle will begin moving forward/reverse.
- To cancel assistance, press the Advanced Park main switch.

If assistance is canceled, “Advanced Park Cancelled” will be displayed.

If you feel that the vehicle is approaching close to a surrounding vehicle, object, person, or gutter: →P.358

4 Perform operations as indicated by the advice displays until the vehicle stops in the target parking space.

When the vehicle stops, “Advanced Park Finished” will be displayed and parking assistance will end.

If you select  on the multimedia display, the vehicle displayed on the parking assist completion

screen will rotate.

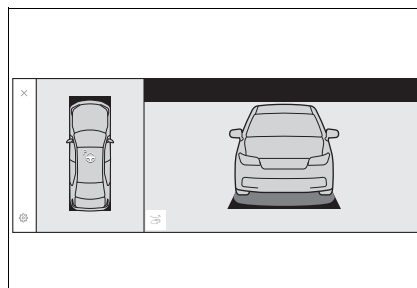

■ If you feel that the vehicle is approaching close to a surrounding vehicle, object, person, or gutter

Depress the brake pedal to stop the vehicle and then change the shift position to change the direction of travel of the vehicle. At this time, assist will be suspended. However, if the “Start” button is selected, assist will resume and the vehicle will move in the direction corresponding to the selected shift position.

 NOTICE

■ When using the perpendicular parking (forward/reverse) function

- Make sure that there are no obstructions within the yellow guide lines and between the vehicle and target parking spot. If there are any obstructions between the vehicle and the target parking space, or between the yellow guide lines, cancel the function.
- As the target parking space will not be able to be set correctly if the surface of the parking space is on a slope or has differences in height, the vehicle may stray from the target parking space or be slanted. Therefore, do not use the function for this kind of parking spot.

 **NOTICE**

- When parking in a narrow parking space, the vehicle may closely approach an adjacent parked vehicle. If a collision seems likely, depress the brake pedal to stop the vehicle.
- If a detected parked vehicle is narrow or parked extremely close to the curb, the position at which assistance will park the vehicle will also be close to the curb. If it seems likely the vehicle will collide with something or drive off of the road, depress the brake pedal to stop the vehicle, and then press the Advance Park main switch to disable the system.

Advanced Park perpendicular exiting (forward/reverse) function

■ **Function description**

When exiting from a perpendicular parking space, if the system determines that exit is possible the perpendicular exiting (forward/reverse) function can be used. Also, depending on the surrounding environment, if it is necessary to change the direction of travel of the vehicle, the shift position can be changed by assistance control.

- **Perpendicular exiting (forward/reverse) function**
- 1 With the brake pedal depressed and P shift position selected, press the Advanced Park main switch

and check that the exit direction selection screen is displayed on the multimedia display.

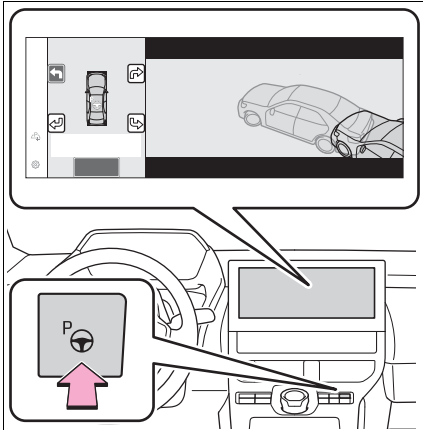

- 2 Select an arrow on the multimedia display to select the direction you wish to exit.

If the turn signal lever is operated, only exit to the left or right can be selected.

- 3 Depress the brake pedal and select "Start" button.

If you feel that the vehicle is approaching close to a surrounding vehicle, object, person, or gutter: →P.360

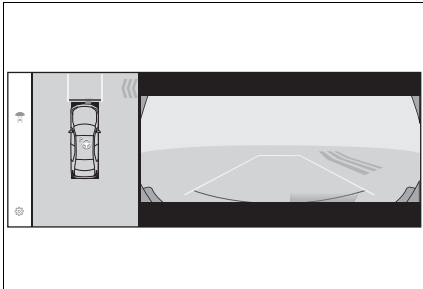

A buzzer will sound, an operation message will be displayed on the multi information display, and assistance will begin operating. To can-

cel assistance, press the Advanced Park main switch. If assistance is canceled, “Advanced Park Canceled” will be displayed.

- 4 Perform operations as indicated by the advice displays until the vehicle is in a position where exit is possible.

If the steering wheel is not operated, the vehicle will stop at the exit position. Assistance can be ended by depressing the accelerator pedal or brake pedal. When the vehicle reaches a position where exit is possible, “You can exit by moving the steering wheel” will be displayed. If the steering wheel is operated, “Advanced Park Finished” will be displayed and assistance will end. Grip the steering wheel and drive forward.

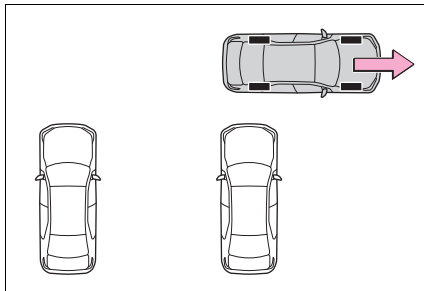

- **If you feel that the vehicle is approaching close to a surrounding vehicle, object, person, or gutter**

Depress the brake pedal to stop the vehicle and then change the shift position to change the direction of travel of the vehicle.

At this time, assist will be suspended. However, if the “Start” button is selected, assist will resume and the vehicle will move in the direction corresponding to the selected shift position.

- **Perpendicular exiting (forward/reverse) function**

Do not use exiting (for-

ward/reverse) function in any situation other than when exiting a parallel parking spot. If assistance is started unintentionally, depress the brake pedal and stop the vehicle, then press the Advanced Park main switch to cancel assistance.

- **Situations in which the perpendicular exiting (forward / reverse) function will not operate**

Situations in which the perpendicular exiting (forward/reverse) function will not operate.

- When a vehicle which is waiting to park is in the exit direction

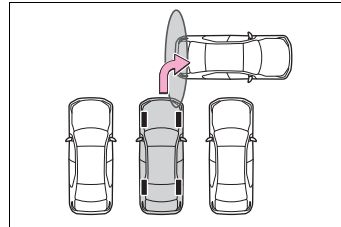

- When a wall, column, or person is detected as near a front or rear center or corner sensor

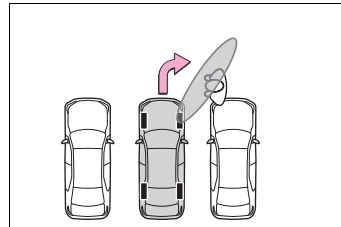

Advanced Park Parallel parking function

- **Function description**

The parallel parking function can be used if the target parking space can be detected when the vehicle is stopped close and aligned with the center of the parking space. Also, depending

on the condition of the parking space, etc., if it is necessary to change the direction of travel of the vehicle, the shift position can be changed by assistance control.

■ **Parking using the parallel parking function**

- 1 Stop the vehicle with it aligned near the center of the target parking space.

- ▶ If there are parking space lines

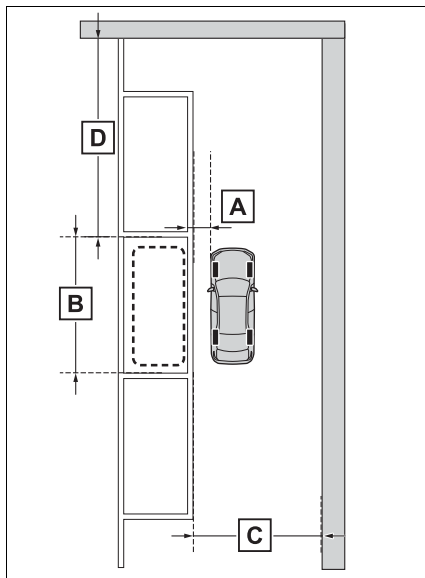

- A** Approximately 3.3 ft. (1 m)*
- B** Approximately 16.4 to 19.7 ft. (5 to 6 m)*
- C** Approximately 14.8 ft. (4.5 m) or more*
- D** Approximately 26.2 ft. (8 m) or more*

*: This is a reference measurement for detection of a parking space. Depending on the surrounding environment, detection may not be possible.

- ▶ If there is an adjacent parked vehicle

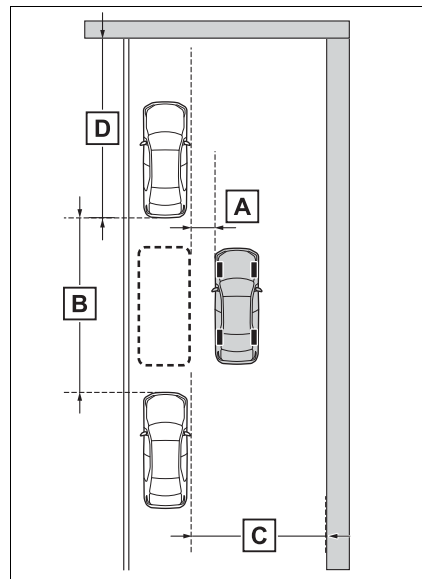



- A** Approximately 3.3 ft. (1 m)*
- B** Approximately 23.0 ft. (7 m) or more*
- C** Approximately 14.8 ft. (4.5 m) or more*
- D** Approximately 26.2 ft. (8 m) or more*

*: This is a reference measurement for detection of a parking space. Depending on the surrounding environment, detection may not be possible.

- 2 Press the Advanced Park main switch and check that a

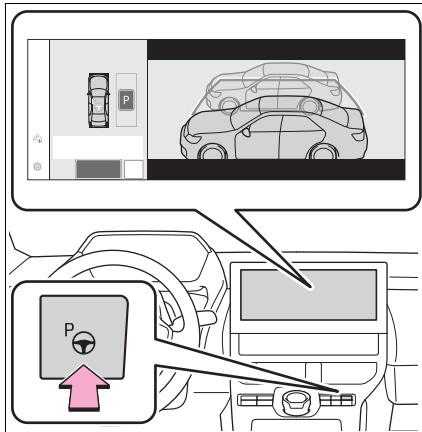
possible parking space is displayed on the multimedia display.



- If a space which your vehicle can be parked is detected, a target parking space box will be displayed.
- If it is possible to perpendicular parking (forward/reverse) in the space, select the parking space, and then select  to change to the perpendicular parking (forward/reverse) function.
- Depending on the surrounding environment, it may not be possible to use this function. According to the information displayed on the multimedia display, use the function on another parking space.

3 Select "Start" button.

A buzzer will sound, an operation message will be displayed on the multi-information display, and assis-

tance will begin operating.

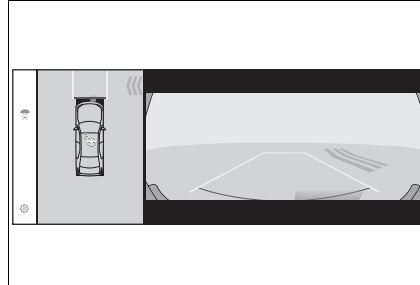

- When the brake pedal is released, "Moving Forward..." will be displayed and the vehicle will begin moving forward.
- To cancel assistance, press the Advanced Park main switch.

If assistance is canceled, "Advanced Park Cancelled" will be displayed.

If you feel that the vehicle is approaching close to a surrounding vehicle, object, person, or gutter: →P.363

- 4 Perform operations as indicated by the advice displays until the vehicle stops in the target parking space.

When the vehicle stops, "Advanced Park Finished" will be displayed and parking assistance will end.

If you select  on the multimedia display, the vehicle displayed on the parking assist completion

screen will rotate.

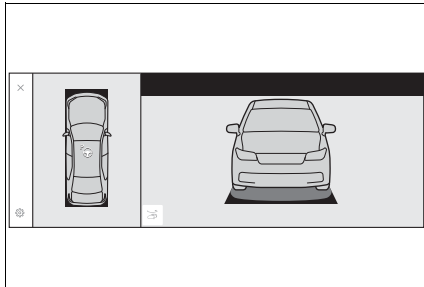

■ **If you feel that the vehicle is approaching close to a surrounding vehicle, object, person, or gutter**

Depress the brake pedal to stop the vehicle and then change the shift position to change the direction of travel of the vehicle.

At this time, assist will be suspended. However, if the “Start” button is selected, assist will resume and the vehicle will move in the direction corresponding to the selected shift position.

■ **If “No available parking space” is displayed**

Even if the vehicle is stopped parallel to a parking space, an adjacent parked vehicle may not be detected. In this case, if the vehicle is moved to a position that a parked vehicle can be detected, assistance can be started.

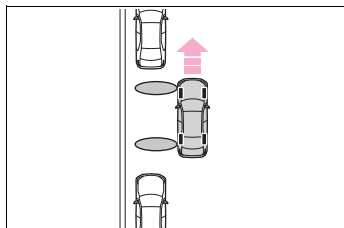

 NOTICE

■ **When using the parallel parking function**

- Make sure that there are no obstructions within the yellow guide lines and between the vehicle and target parking spot. If any obstructions are detected within the yellow guide lines or between the vehicle and the target parking space, the parallel parking function will be cancelled.
- As the target parking space will not be able to be set correctly if the surface of the parking space is on a slope or has differences in height, the vehicle may stray from the target parking space or be slanted. Therefore, do not use the parallel parking function for this kind of parking spot.
- When parking in a narrow parking space, the vehicle may closely approach an adjacent parked vehicle. If a collision seems likely, depress the brake pedal to stop the vehicle.

 NOTICE

- If an adjacent parked vehicle is narrow or parked extremely close to the curb, the position at which assistance will park the vehicle will also be close to the curb. If it seems likely the vehicle will collide with the curb or drive off of the road, depress the brake pedal to stop the vehicle, and then press the Advanced Park main switch to disable the system.

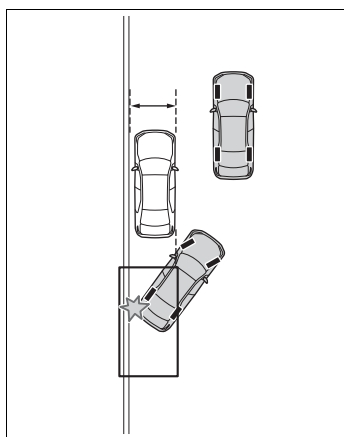

- If there is a wall or other barrier on the inner side of the parking space, the vehicle may stop at a position slightly outside of the set target parking space.

Advanced Park Parallel exiting function

■ **Function description**

When exiting from a parallel parking space, if the system determines that exit is possible the parallel exiting function can be used. Also, depending on the surrounding environment, if it is necessary to change the direc-

tion of travel of the vehicle, the shift position can be changed by assistance control.

■ **Leaving a parking space using the parallel exiting function**

- 1 With the brake pedal depressed and P shift position selected, press the Advanced Park main switch and check that the exit direction selection screen is displayed on the multimedia display.

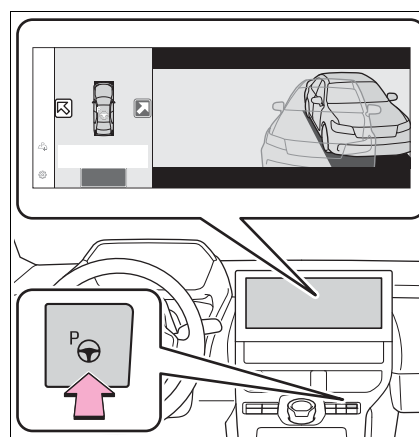

- 2 Select an arrow on the multimedia display to select the direction you wish to exit.

If the turn signal lever is operated, only exit to the left or right can be selected.

- 3 Depress the brake pedal and select "Start" button.

A buzzer will sound, an operation message will be displayed on the multi-information display, and assistance will begin operating.

To cancel assistance, press the Advanced Park main switch.

If assistance is canceled, "Advanced Park Cancelled" will be displayed.

If you feel that the vehicle is approaching close to a surrounding vehicle, object, person, or gutter: →P.365

- 4 Perform operations as indicated by the advice displays until the vehicle is in a position where exit is possible.

If the steering wheel is not operated, the vehicle will stop at the exit position. When the vehicle reaches a position where exit is possible, "You can exit by moving the steering wheel" will be displayed. If the steering wheel is operated, "Advanced Park Finished" will be displayed and assistance will end. Grip the steering wheel and drive forward.

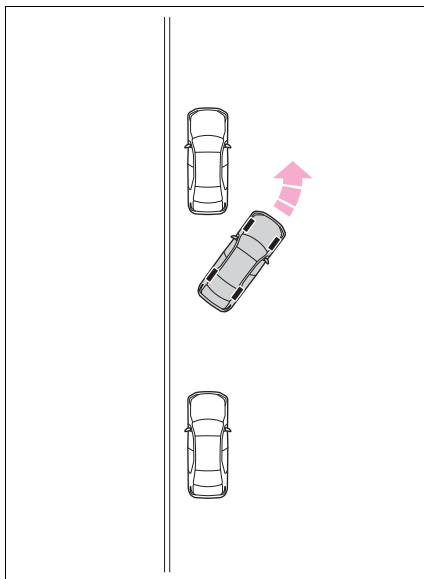

■ **If you feel that the vehicle is approaching close to a surrounding vehicle, object, person, or gutter**

Depress the brake pedal to stop the

vehicle and then change the shift position to change the direction of travel of the vehicle.

At this time, assist will be suspended. However, if the "Start" button is selected, assist will resume and the vehicle will move in the direction corresponding to the selected shift position.

■ **Parallel exiting function**

Do not use parallel exiting function in any situation other than when exiting a parallel parking spot. If assistance is started unintentionally, depress the brake pedal and stop the vehicle, then press the Advanced Park main switch to cancel assistance.

■ **Situations in which the parallel exiting function will not operate**

In situations such as the following, the parallel exiting function will not operate:

- When vehicles waiting at a traffic signal in the exit direction

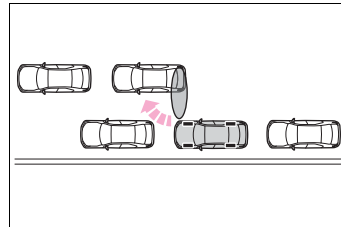

- When a vehicle is stopped in the area behind where the vehicle will exit

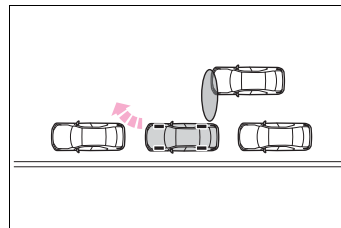

- When a wall, column, or person is detected as near a front or rear side sensor

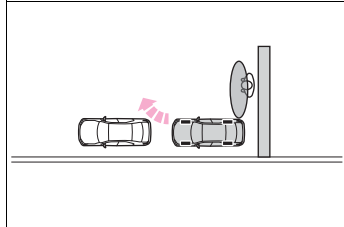

- When the vehicle has been parked on a curb and a side sensor detects the road surface

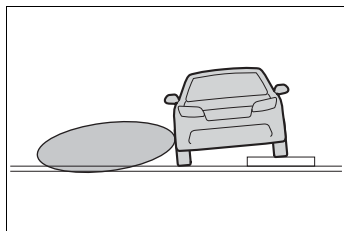

- When a vehicle is not parked in front of the vehicle
- When there is excessive space between the front of the vehicle and a parked vehicle

Advanced Park Memory function

■ Function description

The memory function can be used to park in a previously registered parking space, even if there are no parking space lines or adjacent parked vehicles.

Up to 3 parking spaces can be registered.

■ Registering a parking space

- 1 Stop the vehicle with it aligned near the center of the target parking space.

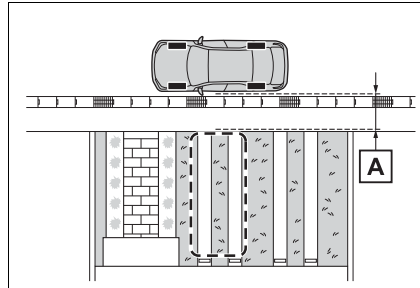

A Approximately 3.3 ft. (1 m)

- 2 Press the main switch and then select $\triangleleft P_{\rightarrow}$

If the Advanced Park main switch is pressed at a parking space without parking lines or any adjacent parked vehicles, "No available parking space" may be displayed.

Continuously select and hold $\triangleleft P_{\rightarrow}$.

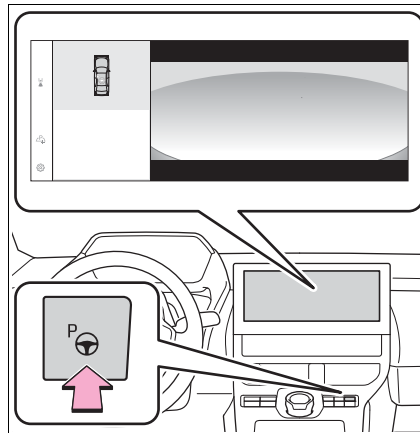

- 3 Select perpendicular parking (forward/reverse) function or parallel parking function.

Only parking spaces for which

assist can be performed are displayed.

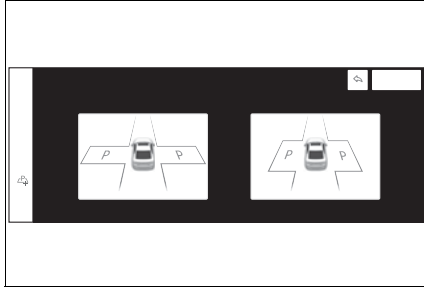

4 Select the parking direction.

When perpendicular parking (forward/reverse) was selected in step 3

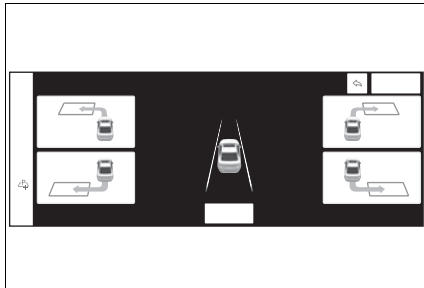

When parallel parking was selected in step 3

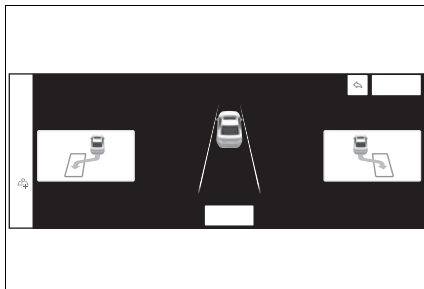

5 Using the arrow buttons, adjust the position of the parking space to be regis-

tered, and then select "OK" button.

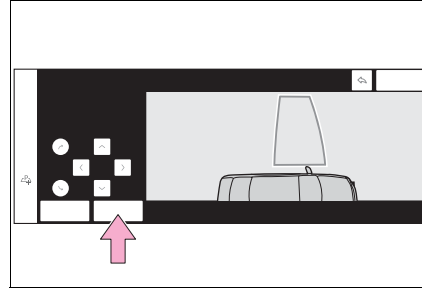

6 Select "Start" button.

A buzzer will sound, an operation message will be displayed on the multi-information display, and assistance will begin operating.

When the brake pedal is released, "Moving Forward..." will be displayed and the vehicle will begin moving forward.

If you feel that the vehicle is approaching close to a surrounding vehicle, object, person, or gutter: →P.369

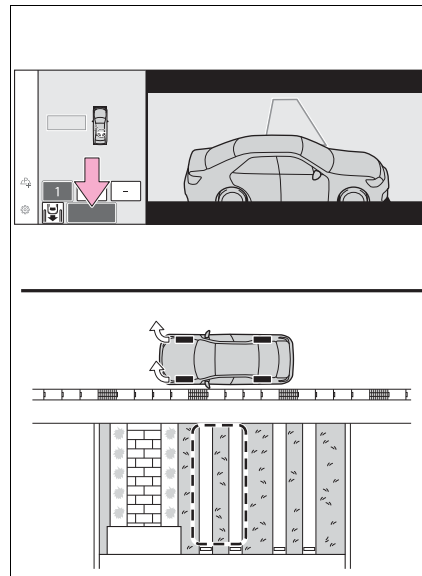

7 Perform operations as indicated by the advice displays

until the vehicle stops in the target parking space.

- 8 Check the position that the vehicle has stopped. If necessary, adjust the position of the parking spot to be registered using the arrow buttons, and then select "Registration" button.

"Registration Completed" will be displayed on the multimedia display.

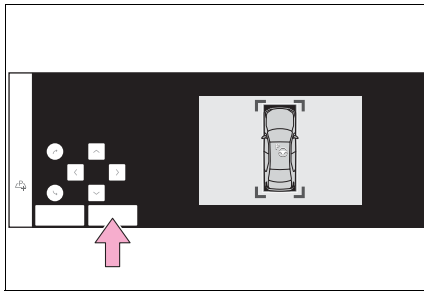

- Register the parking space only if there are no obstructions within the area shown by the thick lines.
- The amount that the position of the parking spot to be registered can be adjusted is limited.

■ **When parking in a parking space registered to the memory function**

- 1 Stop the vehicle with it aligned near the center of the target parking space.

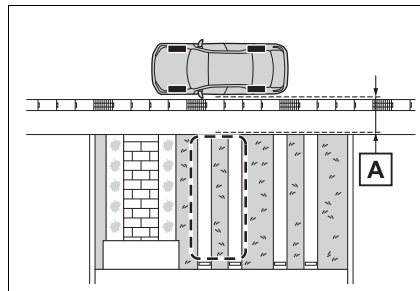

A Approximately 3.3 ft. (1 m)

- 2 Press the Advanced Park main switch and check that a possible parking space is displayed on the multimedia display.

If the "MODE" button is displayed, the button can be touched to change between the memory function, perpendicular parking (forward/reverse) function and parallel parking function.

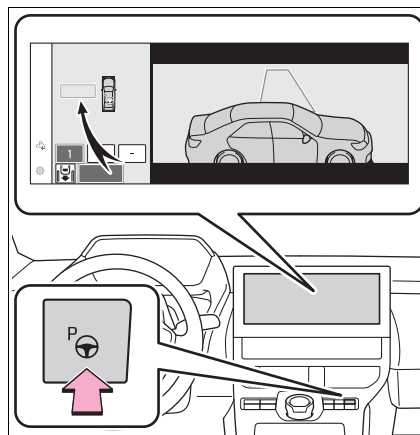

- 3** Select the desired parking space, and then select “Start” button.

Perform the procedure for the perpendicular parking (forward/reverse) function from step **3**. (→P.356)

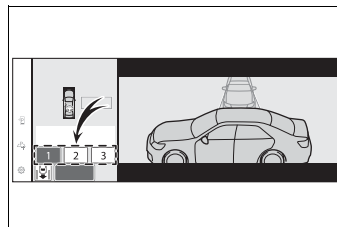

■ **If you feel that the vehicle is approaching close to a surrounding vehicle, object, person, or gutter**

Depress the brake pedal to stop the vehicle and then change the shift position to change the direction of travel of the vehicle.

At this time, assist will be suspended. However, if the “Start” button is selected, assist will resume and the vehicle will move in the direction corresponding to the selected shift position.

■ **When overwriting a registered parking space**

If the maximum number of parking spaces have been registered and  is selected, a registered parking space can be selected and then overwritten with a new parking space.

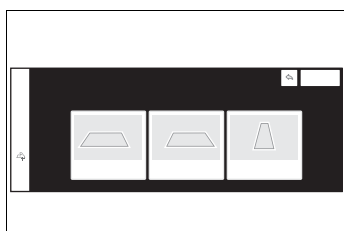

■ **When multiple parking spaces are registered**

Select the desired parking space, and then select “Start” button.

 **NOTICE**

■ **When using the memory function**

- The memory function is a function which provides assistance in parking in a previously registered parking space. If the condition of the road surface, vehicle, or surrounding area differs from when registration was performed, the parking space may not be able to be detected correctly or assistance may not be provided to the point that the vehicle is fully parked.
- Do not register a parking space in situations such as the following, as the set parking space may not be able to be registered or assistance may not be possible later.
 - When a camera lens is dirty or covered with water droplets
 - When it is raining or snowing
 - When the surrounding area is dark (at night, etc.)
- In situations such as the following, it may not be possible to register a parking space.
 - When there is insufficient space between the road and parking space
 - When the road surface around the parking space does not have any differences the system can recognize

 NOTICE

● If a parking space has been registered in situations such as the following, assistance may not be able to be started later or assistance to the registered position may not be possible.

- When shadows are cast on the parking space (there is a carport over the parking space, etc.)

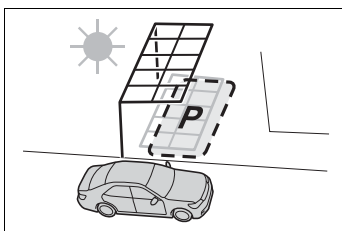

- When there are leaves, garbage, or other objects which will likely move, in the parking space
- When the road surface around the parking space has the same repeating pattern (brick, etc.)

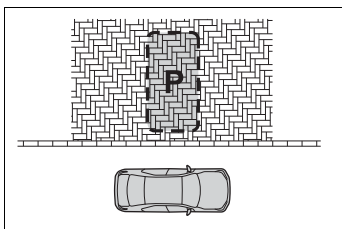

● In situations such as the following, it may not be possible for the system to provide assistance to a registered parking spot:

- When the appearance of the parking space is affected by the shadow of the vehicle or trees
- When an object is detected in the registered parking space

- When a pedestrian or passing vehicle is detected during assistance
- When the position the vehicle is stopped when assistance is started differs from the position when registration was performed
- When the registered parking space cannot be reached due to the existence of parking blocks, etc.
- When the road surface around the parking space has changed (road surface has degraded or been resurfaced)
- When the sunlight conditions differ from when registration was performed (due to weather or time of day)
- When the sun is shining directly into a camera, such as in the early morning or evening
- When the color or brightness of the road surface is uneven
- When a light is temporarily shined on the parking space (lights of another vehicle, security light, etc.)
- When the road surface around the parking space has the same repeating pattern
- When there is a low protrusion on the road surface near the parking space
- When the parking space is on a slope
- When a camera has been splashed by hot or cold water and the lens has fogged up
- When a camera lens is dirty or covered with water droplets

 NOTICE

- When accessories which obstruct the view of the camera are installed

If assistance is ended during registration, perform registration again.

- When registering a parking space to the memory function, if the road surface cannot be detected “No available parking space to register” will be displayed.
- When using the memory function, make sure to stop immediately in front of the stop position. Otherwise the parking space may not be able to be detected correctly or assistance may not be provided to the point that the vehicle is fully parked.
- Do not use the memory function if a camera has been subjected to a strong impact or images of the panoramic view monitor are misaligned.
- If a camera has been replaced, as the installation angle of the camera will have changed, it will be necessary to reregister parking spaces of the memory function.

Remote control function**■ Function description**

A smartphone can be used to remotely operate the parking functions and exit functions. Also, assistance can be provided to remotely move the vehicle forward or backward into a garage, etc.

■ Parking using Remote control function

A smartphone can be used to remotely operate the parking function if the target parking space can be detected when the vehicle is stopped close and perpendicular to the center of the parking space. Also, depending on the condition of the parking space, etc., if it is necessary to change the direction of travel of the vehicle, the shift position can be changed by assistance control.

- 1 Stop the vehicle with it aligned near the center of the target parking space. (→P.356)
- 2 Press the Advanced Park main switch and check that a possible parking space is displayed on the Multimedia display. (→P.356)
- 3 Select the  button and then select [Perpendicular/parallel].
- 4 Select [OK] button.
- 5 Exit the vehicle while carrying the electronic key and smartphone, and then start the Remote Park app on the smartphone.

The detection area of the electronic key is within approximately 9.8 ft. (3 m) around the vehicle.

If there is an obstruction in the path of the vehicle, move it before park-

ing the vehicle. A traffic cone can also be moved after exit the vehicle.

- 6 From outside of the vehicle, confirm the parking space on the screen of the smartphone and then select the start button.

Start operation of Remote control function while standing approximately 1.6 ft. (50 cm) or more from the vehicle and out of the path of the vehicle.

- 7 Checking the safety of the area around the vehicle, trace the operation area on the screen of the smartphone continuously, the vehicle will move and parking assistance will be performed.

If operation of the screen of the smartphone is stopped, assistance can be suspended and the vehicle can be stopped. The doors are automatically locked before the vehicle starts moving.

- 8 When the parking space is reached, after the vehicle is stopped by the parking brake, the shift position will be changed to P, the power switch will be turned off, and the doors will be locked.

A completion screen will be displayed on the smartphone

■ **The parking function can be used even if obstructions exist if**

- When using the parking functions at a parking space made of white lines, even if an obstruction exists in the parking space, the space can be set as the target parking space. This allows for assistance

to continue after setting a parking space from inside the vehicle and then exiting the vehicle to move an obstruction, such as a traffic cone placed in a handicapped parking space.

- When perpendicular parking using Advanced Park, 3 parking spaces on each side of the vehicle (up to 6 total) can be detected. However, when using Remote control function, only 1 parking space on each side of the vehicle can be detected

Moving the vehicle forward and backward using Remote control function

After the vehicle is stopped, assistance can be provided to move the vehicle into a garage, etc., by using the forward and backward movement function.

- 1 Stop the vehicle at the location you would like to start assistance.

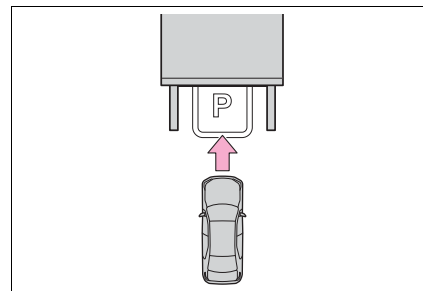

- 2 Press the Advanced Park main switch. (→P.354)
- 3 Select  and then select [Forward/reverse].
- 4 Select [OK].

- 5 Exit the vehicle while carrying the electronic key and smartphone, and then start the Remote Park app on the smartphone.

The detection area of the electronic key is within approximately 9.8 ft. (3 m) around the vehicle.

- 6 From outside of the vehicle, confirm the direction of travel on the screen of the smartphone and then select the start button.

Start operation of Remote control function while standing approximately 1.6 ft. (50 cm) or more from the vehicle and out of the path of the vehicle. The detection area of the electronic key is within approximately 9.8 ft. (3 m) around the vehicle.

- 7 Checking the safety of the area around the vehicle, trace the operation area on the screen of the smartphone continuously, the vehicle will move and parking assistance will be performed.

If operation of the screen of the smartphone is stopped, assistance can be suspended and the vehicle can be stopped. After assistance has been started, it can be stopped part way or the direction of travel of the vehicle can be changed.

- 8 Select the power button on the screen of the smartphone. The power switch will then turn OFF and the doors will lock automatically.

■ Changing the direction of travel
While assistance is being per-

formed, the direction of travel of the vehicle can be changed by the forward and reverse movement function. When there is a wall behind the vehicle, etc., by operating the direction of travel changing button on the screen of the smartphone, the vehicle can be slightly moved forward to allow loading of items and then moved back to its original position.

Exiting using Remote control function

Assistance can be provided to exit from a perpendicular or parallel parking space when the power switch OFF. When forward and backward movement is selected, the maximum distance the vehicle can move is 23.0 ft. (7 m) from the starting point and possible to change the direction of travel.

- 1 While near the parked vehicle, unlock the doors using the electronic key, and then start the Remote Park app on the smartphone.

If the smartphone cannot connect to the vehicle, using the electronic key, unlock the doors again.

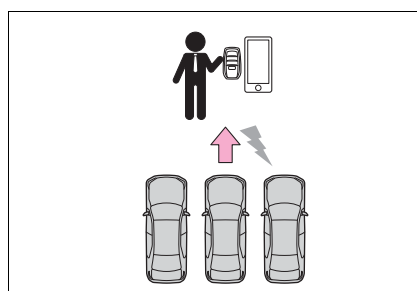

- 2 Select the start button on the screen of the smartphone.

The power switch will change to ON.

- 3 Check that a possible exit direction is displayed, select the exit direction.
- 4 Checking the safety of the area around the vehicle, trace the operation area on the screen of the smartphone continuously, the vehicle will move and parking assistance will be performed.

If operation of the screen of the smartphone is stopped, assistance can be suspended and the vehicle can be stopped. After assistance has been started, it can be stopped part way or the direction of travel of the vehicle can be changed.

- 5 Move the vehicle to the position where assistance ends and enter the vehicle while carrying the electronic key.

To stop assistance part way, stop operating the smartphone or enter the vehicle.

■ While using the remote air conditioner

- Exit assist can be done even when using remote air conditioning.
- When Remote control function is started while the remote air conditioning is operating, if tracing operations are not performed on a smartphone, assistance can be canceled by entering the vehicle and depressing the brake pedal.

Parking using the Remote control function and memory function

A smartphone can be used to remotely operate the memory function if the target parking space can be detected when the vehicle is stopped close to a parking space which was previously registered to the memory function. Also, depending on the condition of the parking space, etc., if it is necessary to change the direction of travel of the vehicle, the shift position can be changed by assistance control.

- 1 Stop the vehicle with it aligned near the center of the target parking space. (→P.366)
- 2 Press the Advanced Park main switch, check that a possible parking space is displayed on the Multimedia display. (→P.366)
- 3 Select the  button and then select [Perpendicular/parallel].
- 4 [OK].

If the [MODE] button is displayed, the button can be selected to change between the memory function, perpendicular parking (forward/reverse) function and parallel parking function.

- 5 Exit the vehicle while carrying the electronic key and smartphone, and then start the

Remote Park app on the smartphone.

The detection area of the electronic key is within approximately 9.8 ft. (3 m) around the vehicle. If there is a cone or other obstruction in the path of the vehicle, move it after exiting the vehicle.

- 6 From outside of the vehicle, confirm the parking space on the screen of the smartphone and then select the start button.

Start operation of Remote control function while standing approximately 1.6 ft. (50 cm) or more from the vehicle and out of the path of the vehicle.

- 7 Checking the safety of the area around the vehicle, trace the operation area on the screen of the smartphone continuously, the vehicle will move and parking assistance will be performed.

If operation of the screen of the smartphone is stopped, assistance can be suspended and the vehicle can be stopped. The doors are automatically locked before the vehicle starts moving.

- 8 When the parking space is reached, after the vehicle is stopped by the parking brake, the shift position will be changed to P, the power switch will be turned off, the doors will be locked and the mirrors will be closed.

A completion screen will then be displayed on the smartphone.

Preparation before using Remote control function

Preparation before using

Make sure to perform the following before using Remote control function:

- 1 Download the Remote Park app from the app store.
- 2 Turn the power switch to ON and register the smartphone as a Bluetooth device to the multimedia system. For details on registering a Bluetooth device, refer to the "MULTIMEDIA OWNER'S MANUAL".
- 3 Setup the Remote Park app and register the vehicle.
- 4 The registered vehicle will be displayed on the screen of the smartphone.

Select the vehicle.

The name and image of the vehicle can be changed on the new vehicle registration screen.

Vehicles can be added through the menu screen.

Remote control function on/off

- 1 Select  and then select "Advanced Park" on the Multimedia display.
- 2 Select "Remote Park" to turn it on/off. (The default setting is on.)

- 3 Press the Advanced Park main switch.

If the switch is pressed while assistance is being performed, the assistance will be canceled.

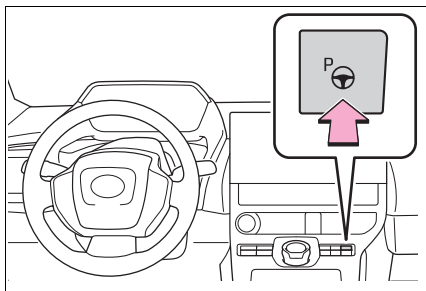

- 4 Select the  button displayed on the multimedia display.

 NOTICE

- When using Remote control function, make sure carry an electronic key in your pocket, etc.
- If an electronic key is held together with a smartphone, etc., the electronic key may not be able to be detected.
- Remote control function cannot be used when carrying only a digital key. The driver should always carry the electronic key.
- When entering the vehicle after using Remote control function, make sure that the electronic key is brought into the vehicle and all of the doors are closed.

- If the power switch is turned off when Remote control function operation has finished or been canceled, the doors will be locked automatically. However, if a door is open, it may not be locked. Check the vehicle condition after Remote control function operation has finished.

- When the doors are locked after Remote control function operation has finished or been canceled, an alarm may sound if someone is detected inside the vehicle.

■ Situations in which the function may not operate correctly

- When the functions of the smart entry & start system may not operate correctly: →P.190

- When the vehicle is near fluorescent lights

■ Radio wave interference

→P.191

■ Electronic key battery consumption

- When Remote control function is being used, the electronic key battery will be used as the electronic key will continuously send and receive radio waves.

- If the electronic key battery is depleted: →P.497

■ Situations in which the sensors may not operate properly

→P.314

- When using Remote control function, visibility of the area around the vehicle may be limited. Make sure to check the following when using Remote control function:

**NOTICE**

- The vehicle and area around the vehicle are clearly visible
- There are no people, animals, or objects in the path of the vehicle
- An appropriate distance from the vehicle can be maintained and the safety of yourself and others can be ensured
- Caution for the area around the vehicle is always maintained and there is no potential for danger
- You can cancel Remote control function immediately if necessary

Advanced Park cancellation/suspension**■ Assistance will be canceled when**

In situations such as the following, Advanced Park operation will be canceled.

As system operation has been canceled, begin the operation again or continue parking manually, using the steering wheel.

- The Advanced Park main switch is pushed
- The shift position has been changed to P
- The parking brake is engaged
- A door or back door is opened
- The driver's seat belt is unfastened
- The outside rear view mirrors

are folded

- The TRAC or VSC is turned off
- The TRAC, VSC or ABS operates
- The power switch is pushed
- The system determines assistance cannot be continued in the current parking environment
- The system malfunctions
- While the vehicle was stopped, "Cancel" was selected on the multimedia display

■ Assistance will be suspended when

In situations such as the following, Advanced Park operation will be suspended.

Assistance can be started again by following the directions displayed on the multimedia display.

Also, when assistance is suspended, if the shift position is changed twice with the brake pedal depressed, assistance will be canceled in that shift position. However, if assistance is suspended by changing the shift position, assistance will be canceled if the shift position is changed once.

- The steering wheel is operated
- The accelerator pedal is depressed
- The shift position has been

changed

- Brake control operates
- Camera switch is pressed
- The PKSB (Parking Support Brake) PCS (Pre-Collision System) has operates

■ **Remote control function assistance will be canceled when**

In situations such as the following, Remote control function operation will be canceled.

As system operation has been canceled, while carrying an electronic key, enter the vehicle and park the vehicle manually, using the steering wheel.

- When a condition for stopping Advanced Park assistance is met, with the exception suspension due to a door being opened or the driver's seat belt being released
- When Remote control function is operated while the remote air conditioning is operating and the power switch is changed to ON before remote air conditioning has ended
- When 5 minutes have elapsed since Remote control function operation was started
- When 3 minutes have elapsed since any operation was performed

- When 30 seconds have elapsed with the vehicle not being able to be driven, even though the screen of the smartphone is being operated to drive the vehicle

- When the power button on the screen of the smartphone is selected

- When the Remote Park app is force closed

- When the vehicle is on a steep slope

- When an electronic key is detected inside the vehicle while Remote control function operation is suspended

- When the ambient temperature is 14°F (-10°C) or less

■ **Remote control function assistance will be suspended when**

In situations such as the following, assistance will be suspended.

- When the Bluetooth communication between the smartphone and multimedia system get lost

- When smartphone continuous operation is suspended

- When the Remote Park app is pushed to the background (a call is received, the home button is pressed, etc.)

- When electronic key does not detected

- When there is an obstruction in the movement direction of the vehicle
- When the vehicle is operated while it is being driven by assistance
- When the smart key is operated while it is being driven by assistance
- When the door is unlocked while it is being driven by assistance
- When a door is opened while the vehicle is being driven

Changing the Advanced Park settings

Select  on the multimedia display, and then select “Advanced Park”.

■ Remote Park

Remote control function can be turned on/off.

■ Speed Profile

The vehicle speed for when assistance is performed can be set.

This setting cannot be changed when registering a parking space to the memory function.

■ Detect. range

The distance from which obstacles will be avoided while assistance is being performed can be set.

■ Prk. Method

The preferred parking direction displayed when at a parking space which perpendicular (forward/reverse) or parallel parking is possible can be set.

■ Prk. direction

The preferred parking direction displayed when it is possible to pull perpendicular forward or reverse into a parking space can be selected.

■ Exit dir .: Per.

The preferred exit direction displayed when it is possible to pull forward or reverse to the left or right out of a parking space can be selected.

■ Exit dir .: Par.

The preferred exit direction displayed when it is possible to exit to the left or right from a parallel parking space can be selected.

■ Parking view

The display angle of the camera image when using the perpendicular parking (forward/reverse) function or parallel parking function can be set.

■ Exit view

The display angle of the camera image when using the perpendicular exiting (forward/reverse) function or parallel parking exit function can be set.

■ Parking Path Adjustment

The course for when parking assistance is operating can be adjusted inward or outward.

If the tires are worn, the path of vehicle may be offset from the center of the parking space. In this case, use this setting to adjust the parking course.

■ Road Width Adjustment

When parking assistance is started, the amount of lateral movement while the vehicle is moving forward can be adjusted.

■ Park Position Adjustment (fwd.)

The position at which perpendicular parking (forward/reverse) is completed can be adjusted. (Except when using the memory function.)

■ Park Position Adjustment (rev.)

The position at which perpendicular parking (forward/reverse) is completed can be adjusted. (Except when using the memory function.)

■ Rear Accessory Setting

If an accessory, such as a trailer hitch, has been installed to the rear of the vehicle, the length of the rear of the vehicle can be adjusted to help avoid colliding with objects to the rear of the vehicle.

■ Clear Registered Parking Space

The parking spaces registered to the memory function can be deleted. Parking space information cannot be deleted when assistance is being performed or when registering parking space information to the memory function.

Changing the Remote Park app settings**■ Intuitive parking assist-sensor warning sound ON/OFF (Smartphone setting)**

The warning sounds of the intuitive parking assist-sensor from smartphone application can be turned on/off using the Remote Park app.

■ Intuitive parking assist-sensor warning sound volume adjustment (Smartphone setting)

The volume of the warning sounds of the intuitive parking assist-sensor from smartphone application can be adjusted using the Remote Park app.

Advanced Park Displayed messages

The operating state, assistance operation, etc. of the Advanced Park is displayed on the multimedia display. If a message is

displayed, respond according to the content displayed.

Operate the system at a parking space where differences in the road surface can be recognized.
(→P.366)

■ **If “No available parking space” is displayed**

Move the vehicle to a location where a parking space or parking lines can be detected.

■ **If “Unavailable in current condition” is displayed**

Move the vehicle to another location and use the system.

■ **If “Not enough space to exit” is displayed**

The parallel parking exit function cannot be used due to a situation such as the distance between your vehicle and vehicles parked in front of and behind your vehicle being short, the existence of an object in the exit direction, etc.

Check the conditions of the area around your vehicle and exit from the parking space manually.

■ **If “Cannot control speed” is displayed**

The system judged that it cannot adjust the speed of the vehicle when using the system in an area with a slope or step and assistance was canceled.

Use the system in a level location.

■ **If “Obstacle detected” is displayed**

The emergency support brake operated, and assistance was suspended.

Check the condition of the surrounding area. To resume assistance, select the “Start” button on the multimedia display.

■ **If “No available parking space to register” is displayed**

This message is displayed when  is selected at a parking space that cannot be detected.

Snow mode*

*: If equipped

Snow mode can be selected to suit the conditions when driving on slippery road surfaces, such as on snow.

System operation

Press the snow mode switch

When the switch is pressed, snow mode turns on and the snow mode indicator illuminates on the multi-information display. When the switch is pressed again, the snow mode indicator turns off.

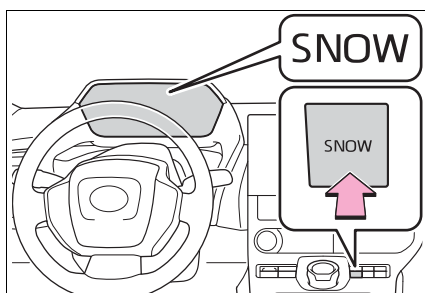

■ Snow Mode Automatic Cancellation

Snow mode is automatically canceled by turning off the power switch or selecting Regeneration Boost.

■ When Snow Mode is not available

When Regeneration Boost is selected, it is not possible to switch to snow mode.

X-MODE*

*: If equipped

This mode has improved road handling ability off roads.

Select between the 2 types of mode, SNOW/DIRT and D.SNOW/MUD.

During “X-MODE”, the downhill assist control will control the brakes to maintain a constant vehicle speed when driving on steep descents.

Grip Control supports the driver’s operation by maintaining a low vehicle speed on steep inclines and slippery roads without having to step on the accelerator pedal or brake pedal.

⚠ WARNING

■ Be sure to observe the following before using “X-MODE”

If not observed, there is the danger that it may lead to an unexpected accident.

- Drive the vehicle after checking that the SNOW/DIRT indicator/D.SNOW/MUD indicator turns on.
- “X-MODE” is not a device that enhances the limited performance of the vehicle. Carefully check the road surface conditions and the driving route in advance, and then drive with caution.

⚠ WARNING

■ **Conditions in which it may not function correctly**

When driving on the following road surfaces, it may not be possible to maintain a constant speed of the vehicle, which may lead to an unexpected accident.

- Extremely steep inclines
- Rough road surfaces
- Slippery road surfaces such as snowy roads and frozen road surfaces

less than approximately 13 mph (20 km/h).

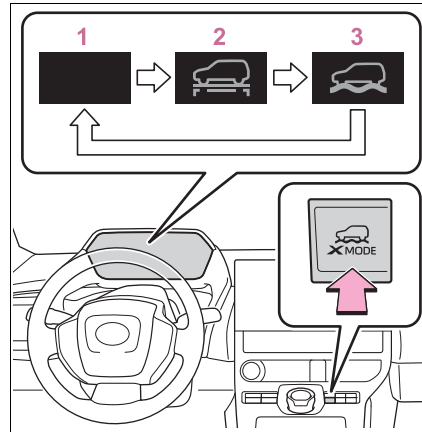

System Components

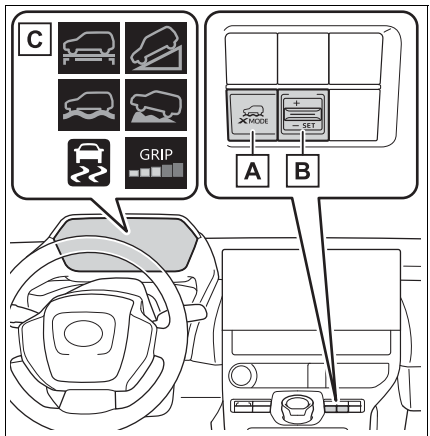

- A** "X-MODE" switch
- B** Grip Control switch (→P.385)
- C** Indicators

Selecting the Drive Mode

Press the "X-MODE" switch repeatedly until the system switches to the desired driving mode while the vehicle is stopped or traveling at a speeds

- 1 Normal mode**
Has a good balance of electrical consumption performance, quietness, and driving performance, and is suitable for driving in urban areas.
- 2 SNOW/DIRT mode**
When the tires are likely to slip or slip on slippery roads such as snowy roads, gravel roads, etc., the tire spinning is reduced, making it easier to drive.
At this time, the SNOW/DIRT mode indicator lights up in green on the meter.
- 3 D.SNOW/MUD mode**
In special cases such as the tires being buried in deep snow or mud, the TRAC (Traction Control) function is temporarily canceled, and the tires are idled as needed to make it easier to start.
At this time, the D.SNOW/MUD mode indicator lights up in green on the meter. In addition, the VSC OFF indicator and PCS warning light will be turned on in the meter.

5
Driving

■ When “X-MODE” is not available

In the following cases, the system does not operate.

- When the EV system is not started
- When SNOW/DIRT mode or D.SNOW/MUD mode is not selected
- When Regeneration Boost is selected
- When Advanced Park is being used
- When the EV system is malfunctioning

■ About Dynamic Radar Cruise Control or Cruise Control

Dynamic radar cruise control and cruise control cannot be used during “X-MODE”. If dynamic radar cruise control or cruise control are being used, it will be automatically canceled.

■ During “X-MODE”

- In “X-MODE”, VSC does not switch ON/OFF even if the VSC OFF switch is operated. It is fixed as ON in SNOW/DIRT mode and OFF in D.SNOW/MUD mode.
- During “X-MODE”, even if the Eco mode switch or regeneration boost switch is operated, operations will not switch to the respective modes.

■ “X-MODE” Automatic Release

- “X-MODE” is automatically canceled when the power switch is turned OFF.
- When the vehicle speed exceeds about 25 mph (40 km/h), the X-MODE is canceled, the “X-MODE” indicator on the meter lights up in white, and switches to the normal mode.
- When the vehicle speed is approximately 22 mph (35 km/h) or less, “X-MODE” indicator lights up in green and switches to X-

MODE again.

■ Cautions regarding the use of the system

For safety, the following operations are not accepted when “X-MODE” is ON.

- Eco mode switch operations
- Regeneration Boost switch operations

When selecting “X-MODE”, Downhill Assist Control

When the “X-MODE” switch is pressed and SNOW/DIRT mode or D.SNOW/MUD mode is selected, the Downhill Assist Control automatically enters the standby state and operates under the following conditions.

- When the vehicle speed is approximately 18 mph (30 km/h) or less
- Neither the accelerator pedal or brake pedal are not operated

■ When changing the target vehicle speed

When changing the target vehicle speed, adjust it with the accelerator pedal or the brake pedal. When the foot is removed from the pedal, the system will operate at the vehicle speed at that time.

■ Downhill Assist Control during “X-MODE”

- In SNOW/DIRT mode or D.SNOW/MUD mode, the downhill assist control can be set to standby state. The operation indicator changes depending on the operating status of the downhill

assist control.

- When the system is not operating, the indicator turns on white.

■ When Downhill Assist Control is not available when selecting “X-MODE”

In the following cases, the system does not operate.

- When SNOW/DIRT mode or D.SNOW/MUD mode is not selected
- When the shift position is in P
- When the Grip Control is operating
- When the brake system or EV system is malfunctioning

When using Grip Control

With SNOW/DIRT mode or D.SNOW/MUD mode selected, press down on the Grip Control switch.

At this time, the downhill assist control system indicator turns off and the Grip Control indicator turns on.

When the vehicle is stopped, press the brake pedal firmly and operate the switch. The vehicle may start moving unintentionally on an incline.

■ Set the speed of the Grip Control

Press the Grip Control switch up or down to set the desired speed (approximately 2 to 6 mph [2 to 10 km/h]). The set speed is shown on the multi-information display.

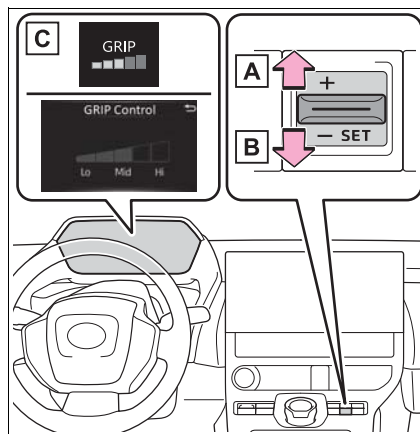

A Increase Speed

B Decrease Speed

C Indicator Lights

■ Grip Control Operations

During system operations, the Grip Control indicator turns on green. If the Grip Control indicator is white, release the brake pedal to activate the system.

While the system is operating, the accelerator pedal and brake pedal can be used to temporarily accelerate or decelerate. If operating the accelerator pedal or brake pedal is stopped, the speed will return to the set speed.

■ When Grip Control is released

- Press the “X-MODE” Switch

When the Grip Control is released, the Grip Control operation light turns off, and after a while, the downhill assist control system indicator light turns on.

Drive carefully when releasing Grip Control while driving.

■ **Grip Control Operations Conditions**

- When in “X-MODE”
- When the shift position is in D
- When the parking brake has been released
- When the driver side door is closed
- When the vehicle is stopped by stepping on the brake or the vehicle speed is approximately 2 to 6 mph [2 to 10 km/h]

■ **Automatic Releasing the Grip Control**

In case of any of the following, the Grip Control is released.

- When the vehicle is stopped by stepping on the brake pedal
- When the vehicle speed exceeds more than 13 mph (20 km/h)
- When the shift position in a position other than D
- When the parking brake is operated
- When the driver side door is opened
- ABS/VSC is activated.
- When brake control and output suppression by the driving support device are activated (example: Pre-Collision System, Parking Support Brake (If equipped))
- When the system determines it cannot continue in the current environment
- When the power switch is turned OFF

■ **When Grip Control is not available**

In the following conditions, Grip Control is not available.

- When the brake system or EV

system is malfunctioning

- After the EV system is started and until the vehicle has been running for a while

■ **Brake hold system**

The brake hold system turns OFF when the Grip Control is being used. Press the brake pedal firmly and operate the switch.

When using the brake hold system again, turn ON the brake hold system after releasing the Grip Control.

 NOTICE

■ **Long term usage**

If used continuously for a long periods of time, the temperature of the brakes may rise the system may temporarily stop.

■ **Operation noises and vibrations**

- Operating noise may be heard from motor room, however this is not a malfunction.
- When the brake pedal is depressed, it may become harder than usual or it may feel different from normal, but this is not a malfunction.

■ **When the operation indicator does not turn on in the meter even after operating the switch**

The system may not be working properly. Have the vehicle inspected at your Toyota dealer.

Driving assist systems

To keep driving safety and performance, the following systems operate automatically in response to various driving situations. Be aware, however, that these systems are supplementary and should not be relied upon too heavily when operating the vehicle.

Summary of the driving assist systems

■ ECB (Electronically Controlled Brake System)

The electronically controlled system generates braking force corresponding to the brake operation

■ ABS (Anti-lock Brake System)

Helps to prevent wheel lock when the brakes are applied suddenly, or if the brakes are applied while driving on a slippery road surface

■ Brake assist

Generates an increased level of braking force after the brake pedal is depressed when the system detects a panic stop situation

■ VSC (Vehicle Stability Control)

Helps the driver to control skidding when swerving suddenly or turning on slippery road surfaces.

■ Trailer Sway Control

Helps the driver to control trailer sway by selectively applying brake pressure for individual wheels and reducing driving torque when trailer sway is detected.

■ TRAC (Traction Control)

Helps to maintain drive power and prevent the drive wheels from spinning when starting the vehicle or accelerating on slippery roads

■ Active Cornering Assist (ACA)

Helps to prevent the vehicle from drifting to the outer side by performing inner wheel brake control when attempting to accelerate while turning

■ Hill-start assist control

Helps to reduce the backward movement of the vehicle when starting on an uphill

■ EPS (Electric Power Steering)

Employs an electric motor to reduce the amount of effort needed to turn the steering wheel.

■ **The Secondary Collision Brake**

When the SRS airbag sensor detects a collision and the system operates, the brakes and brake lights are automatically controlled to reduce the vehicle speed and help reduce the possibility of further damage due to a secondary collision.

■ **When the TRAC/VSC/ABS/Trailer Sway Control systems are operating**

The slip indicator light will flash while the TRAC/VSC/ABS/Trailer Sway Control systems are operating.

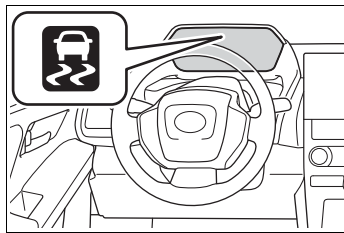

■ **Disabling the TRAC system**

If the vehicle gets stuck in mud, dirt or snow, the TRAC system may reduce power from the EV system to the wheels.

Pressing  to turn the system off may make it easier for you to rock the vehicle in order to free it.

To turn the TRAC system off, quickly press and release .

The “Traction Control Turned OFF” will be shown on the multi-information display.

Press  again to turn the system back on.

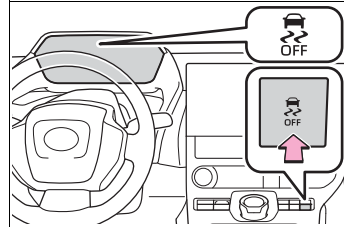

■ **Turning off both TRAC, VSC and Trailer Sway Control systems**

To turn the TRAC/VSC/Trailer Sway Control systems off, press and hold

 for more than 3 seconds while the vehicle is stopped.

The VSC OFF indicator light will come on and the “Traction Control Turned OFF” will be shown on the multi-information display.*

Press  again to turn the systems back on.

*: PCS (Pre-Collision System) will also be disabled (only pre-collision warning is available). The PCS warning light will come on and a message will be displayed on the multi-information display. (→P.270)

■ **When the message is displayed on the multi-information display showing that TRAC has been disabled even if  has not been pressed**

TRAC is temporary deactivated. If the information continues to show, contact your Toyota dealer.

■ **Operating conditions of hill-start assist control**

When all of the following conditions are met, the hill-start assist control will operate:

- The shift position is in a position other than P or N (when starting off forward/backward on an

upward incline)

- The vehicle is stopped
- The accelerator pedal is not depressed
- The parking brake is not engaged
- Power switch is turned to ON

■ Automatic system cancelation of hill-start assist control

The hill-start assist control will turn off in any of the following situations:

- The shift position is shifted to P or N
- The accelerator pedal is depressed
- The brake pedal is depressed and the parking brake is engaged
- A maximum of 2 seconds have elapsed after the brake pedal is released
- Power switch is turned to OFF

■ Sounds and vibrations caused by the ABS, brake assist, VSC, Trailer Sway Control, TRAC and hill-start assist control systems

- A sound may be heard from the motor compartment when the brake pedal is depressed repeatedly, when the EV system is started or just after the vehicle begins to move. This sound does not indicate that a malfunction has occurred in any of these systems.
- Any of the following conditions may occur when the above systems are operating. None of these indicates that a malfunction has occurred.
 - Vibrations may be felt through the vehicle body and steering.
 - A motor sound may be heard also after the vehicle comes to a stop.

■ ECB operating sound

ECB operating sound may be heard in the following cases, but it does not indicate that a malfunction has occurred.

- Operating sound heard from the

motor compartment when the brake pedal is operated.

- Operating sound heard from the motor compartment when one or two minutes passed after the stop of the EV system.

■ Active Cornering Assist operation sounds and vibrations

When the Active Cornering Assist is operated, operation sounds and vibrations may be generated from the brake system, but this is not a malfunction.

■ EPS operation sound

When the steering wheel is operated, a motor sound (whirring sound) may be heard. This does not indicate a malfunction.

■ Automatic reactivation of TRAC, Trailer Sway Control and VSC systems

After turning the TRAC, Trailer Sway Control and VSC systems off, the systems will be automatically re-enabled in the following situations:

- When the power switch is turned off
- If only the TRAC system is turned off, the TRAC will turn on when vehicle speed increases. If both the TRAC and VSC systems are turned off, automatic re-enabling will not occur when vehicle speed increases

■ Operating conditions of Active Cornering Assist

The system operates when the following occurs.

- TRAC/VSC can operate
- The driver is attempting to accelerate while turning
- The system detects that the vehicle is drifting to the outer side
- The brake pedal is released

■ Reduced effectiveness of the EPS system

The effectiveness of the EPS sys-

tem is reduced to prevent the system from overheating when there is frequent steering input over an extended period of time. The steering wheel may feel heavy as a result. Should this occur, refrain from excessive steering input or stop the vehicle and turn the EV system off. The EPS system should return to normal within 10 minutes.

■ **Secondary Collision Brake operating conditions**

The system operates when the SRS airbag sensor detects a collision while the vehicle is in motion. However, the system does not operate when the components are damaged.

■ **Secondary Collision Brake automatic cancellation**

The system is automatically canceled in any of the following situations.

- The vehicle speed drops to approximately 0 mph (0 km/h)
- A certain amount of time elapses during operation
- The accelerator pedal is depressed a large amount

 **WARNING**

■ **The ABS does not operate effectively when**

- The limits of tire gripping performance have been exceeded (such as excessively worn tires on a snow covered road).
- The vehicle hydroplanes while driving at high speed on wet or slick roads.

■ **Stopping distance when the ABS is operating may exceed that of normal conditions**

The ABS is not designed to shorten the vehicle's stopping distance. Always maintain a safe distance from the vehicle in front of you, especially in the following situations:

- When driving on dirt, gravel or snow-covered roads
- When driving with tire chains
- When driving over bumps in the road
- When driving over roads with potholes or uneven surfaces

■ **TRAC/VSC may not operate effectively when**

Directional control and power may not be achievable while driving on slippery road surfaces, even if the TRAC/VSC system is operating. Drive the vehicle carefully in conditions where stability and power may be lost.

■ **Active Cornering Assist does not operate effectively when**

- Do not overly rely on Active Cornering Assist. Active Cornering Assist may not operate effectively when accelerating down slopes or driving on slippery road surfaces.
- When Active Cornering Assist frequently operates, Active Cornering Assist may temporarily stop operating to ensure proper operation of the brakes, TRAC and VSC.

■ **Hill-start assist control does not operate effectively when**

- Do not overly rely on hill-start assist control. Hill-start assist control may not operate effectively on steep inclines and roads covered with ice.

⚠ WARNING

- Unlike the parking brake, hill-start assist control is not intended to hold the vehicle stationary for an extended period of time. Do not attempt to use hill-start assist control to hold the vehicle on an incline, as doing so may lead to an accident.

■ **When the TRAC/ABS/VSC/Trailer Sway Control is activated**

The slip indicator light flashes. Always drive carefully. Reckless driving may cause an accident. Exercise particular care when the indicator light flashes.

■ **When the TRAC/VSC/Trailer Sway Control systems are turned off**

Be especially careful and drive at a speed appropriate to the road conditions. As these are the systems to help ensure vehicle stability and driving force, do not turn the TRAC/VSC/Trailer Sway Control systems off unless necessary.

Trailer Sway Control is part of the VSC system and will not operate if VSC is turned off or experiences a malfunction.

■ **Replacing tires**

Make sure that all tires are of the specified size, brand, tread pattern and total load capacity. In addition, make sure that the tires are inflated to the recommended tire inflation pressure level.

The ABS, TRAC, VSC and Trailer Sway Control systems will not function correctly if different tires are installed on the vehicle. Contact your Toyota dealer for further information when replacing tires or wheels.

■ **Handling of tires and the suspension**

Using tires with any kind of problem or modifying the suspension will affect the driving assist systems, and may cause a system to malfunction.

■ **Trailer Sway Control precaution**

The Trailer Sway Control system is not able to reduce trailer sway in all situations. Depending on many factors such as the conditions of the vehicle, trailer, road surface and driving environment, the Trailer Sway Control system may not be effective. Refer to your trailer owner's manual for information on how to tow your trailer properly.

■ **If trailer sway occurs**

Observe the following precautions. Failing to do so may cause death or serious injury.

- Firmly grip the steering wheel. Steer straight ahead. Do not try to control trailer swaying by turning the steering wheel.
- Begin releasing the accelerator pedal immediately but very gradually to reduce speed. Do not increase speed. Do not apply vehicle brakes.

If you make no extreme correction with the steering or brakes, your vehicle and trailer should stabilize. (→P.229)



WARNING

■ **Secondary Collision Brake**

Do not rely solely upon the Secondary Collision Brake. This system is designed to help reduce the possibility of further damage due to a secondary collision, however, that effect changes according to various conditions. Overly relying on the system may result in death or serious injury.

Winter driving tips

Carry out the necessary preparations and inspections before driving the vehicle in winter. Always drive the vehicle in a manner appropriate to the prevailing weather conditions.

Pre-winter preparations

- Use fluids that are appropriate to the prevailing outside temperatures.
 - Power control unit coolant
 - Heater coolant
 - Washer fluid
- Have a service technician inspect the condition of the 12-volt battery.
- Have the vehicle fitted with four snow tires or purchase a set of tire chains for the front tires.

Ensure that all tires are the same size and brand, and that chains match the size of the tires.

 **WARNING**

■ **Driving with snow tires**

Observe the following precautions to reduce the risk of accidents. Failure to do so may result in a loss of vehicle control and cause death or serious injury.

- Use tires of the specified size.
- Maintain the recommended level of air pressure.

● Do not drive in excess of 75 mph (120 km/h), regardless of the type of snow tires being used.

● Use snow tires on all, not just some wheels.

■ **Driving with tire chains**

Observe the following precautions to reduce the risk of accidents. Failure to do so may result in the vehicle being unable to be driven safely, and may cause death or serious injury.

● Do not drive in excess of the speed limit specified for the tire chains being used, or 30 mph (50 km/h), whichever is lower.

● Avoid driving on bumpy road surfaces or over potholes.

● Avoid sudden acceleration, abrupt steering, sudden braking and shifting operations that cause sudden regenerative braking.

● Slow down sufficiently before entering a curve to ensure that vehicle control is maintained.

● Do not use LTA (Lane Tracing Assist).

 **NOTICE**

■ **Repairing or replacing snow tires**

Request repairs or replacement of snow tires from your Toyota dealer or legitimate tire retailers. This is because the removal and attachment of snow tires affects the operation of the tire pressure warning valves and transmitters.

Before driving the vehicle

Perform the following according

to the driving conditions:

- Do not try to forcibly open a window or move a wiper that is frozen. Pour warm water over the frozen area to melt the ice. Wipe away the water immediately to prevent it from freezing.
- To ensure proper operation of the climate control system fan, remove any snow that has accumulated on the air inlet vents in front of the windshield.
- Check for and remove any excess ice or snow that may have accumulated on the exterior lights, vehicle's roof, chassis, around the tires or on the brakes.
- Remove any snow or mud from the bottom of your shoes before getting in the vehicle.

When driving the vehicle

Accelerate the vehicle slowly, keep a safe distance between you and the vehicle ahead, and drive at a reduced speed suitable to road conditions.

When parking the vehicle

- Turn automatic mode of the parking brake off. Otherwise, the parking brake may freeze and not be able to be released automatically.

Also, avoid using the following as the parking brake may operate automatically, even if automatic mode is off.

- Brake hold system
- Remote parking function
- Park the vehicle and shift the shift position to P without setting the parking brake. The parking brake may freeze up, preventing it from being released. If the vehicle is parked without setting the parking brake, make sure to block the wheels. Failure to do so may be dangerous because it may cause the vehicle to move unexpectedly, possibly leading to an accident. When the parking brake is in automatic mode, release the parking brake after shifting the shift position to P. (→P.244)
- If the vehicle is parked without setting the parking brake, confirm that the shift position cannot be moved out of P.
- If the vehicle is left parked with the brakes damp in cold temperatures, there is a possibility of the brakes freezing.

⚠ WARNING

■ **When parking the vehicle**

When parking the vehicle without applying the parking brake, make sure to chock the wheels. If you do not chock the wheels, the vehicle may move unexpectedly, possibly resulting in an accident.

Selecting tire chains

Use the correct tire chain size when mounting the tire chains. Chain size is regulated for each tire size.

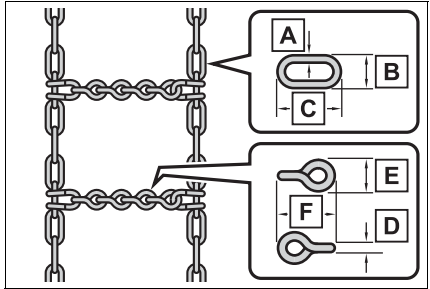

- Side chain:
- A** 0.12 in. (3 mm) in diameter
 - B** 0.39 in. (10 mm) in width
 - C** 1.18 in. (30 mm) in length
- Cross chain:
- D** 0.16 in. (4 mm) in diameter
 - E** 0.55 in. (14 mm) in width
 - F** 0.98 in. (25 mm) in length

Regulations on the use of tire chains

Regulations regarding the use of tire chains vary depending on

location and type of road. Always check local regulations before installing chains.

■ **Tire chain installation**

Observe the following precautions when installing and removing chains:

- Install and remove tire chains in a safe location.
- Install tire chains on the front tires only. Do not install tire chains on the rear tires.
- Install tire chains on front tires as tightly as possible. Retighten chains after driving 1/4 - 1/2 mile (0.5 - 1.0 km).
- Install tire chains following the instructions provided with the tire chains.

⚠ NOTICE

■ **Fitting tire chains**

The tire pressure warning valves and transmitters may not function correctly when tire chains are fitted.

Utility vehicle precautions

This vehicle belongs to the utility vehicle class, which has higher ground clearance and narrower tread in relation to the height of its center of gravity to make it capable of performing in a wide variety of off-road applications.

Utility vehicle feature

- Specific design characteristics give it a higher center of gravity than ordinary passenger cars. This vehicle design feature causes this type of vehicle to be more likely to rollover. And, utility vehicles have a significantly higher rollover rate than other types of vehicles.
- An advantage of the higher ground clearance is a better view of the road allowing you to anticipate problems.
- It is not designed for cornering at the same speeds as ordinary passenger cars any more than low-slung sports cars are designed to perform satisfactorily under off-road conditions. Therefore, sharp turns at excessive speeds may cause the vehicle to rollover.

WARNING

■ Utility vehicle precautions

Always observe the following precautions to minimize the risk of death, serious injury or damage to your vehicle:

- In a rollover crash, an unbelted person is significantly more likely to die than a person wearing a seat belt. Therefore, the driver and all passengers should always fasten their seat belts.
- Avoid sharp turns or abrupt maneuvers, if at all possible. Failure to operate this vehicle correctly may result in loss of control or vehicle rollover causing death or serious injury.
- Loading cargo on the roof luggage carrier (if equipped) will make the center of the vehicle gravity higher. Avoid high speeds, sudden starts, sharp turns, sudden braking or abrupt maneuvers, otherwise it may result in loss of control or vehicle rollover due to failure to operate this vehicle correctly.
- Always slow down in gusty crosswinds. Because of its profile and higher center of gravity, your vehicle is more sensitive to side winds than an ordinary passenger car. Slowing down will allow you to have better control.
- Do not drive horizontally across steep slopes. Driving straight up or straight down is preferred. Your vehicle (or any similar off-road vehicle) can tip over sideways much more easily than forward or backward.

Off-road driving

When driving your vehicle off-

road, please observe the following precautions to ensure your driving enjoyment and to help prevent the closure of areas to off-road vehicles:

- Drive your vehicle only in areas where off-road vehicles are permitted to travel.
- Respect private property. Get owner's permission before entering private property.
- Do not enter areas that are closed. Honor gates, barriers and signs that restrict travel.
- Stay on established roads. When conditions are wet, driving techniques should be changed or travel delayed to prevent damage to roads.

■ **Additional information for off-road driving**

- ▶ For owners in U.S. mainland and Hawaii:

To obtain additional information pertaining to driving your vehicle off-road, consult the following organizations:

- State and Local Parks and Recreation Departments
- State Motor Vehicle Bureau
- Recreational Vehicle Clubs
- U.S. Forest Service and Bureau of Land Management



WARNING

■ **Off-road driving precautions**

Always observe the following precautions to minimize the risk of death, serious injury or damage to your vehicle:

- Drive carefully when off the road. Do not take unnecessary risks by driving in dangerous places.
- Do not grip the steering wheel spokes when driving off-road. A bad bump could jerk the wheel and injure your hands. Keep both hands and especially your thumbs on the outside of the rim.
- Always check your brakes for effectiveness immediately after driving in sand, mud, water or snow.
- After driving through tall grass, mud, rock, sand, rivers, etc., check that there is no grass, bush, paper, rags, stone, sand, etc. adhering or trapped on the underbody. Clear off any such matter from the underbody. If the vehicle is used with these materials trapped or adhering to the underbody, a breakdown or fire could occur.

 **WARNING**

- When driving off-road or in rugged terrain, do not drive at excessive speeds, jump, make sharp turns, strike objects, etc. This may cause loss of control or vehicle rollover causing death or serious injury. You are also risking expensive damage to your vehicle's suspension and chassis.

 **NOTICE**

■ **To prevent the water damage**

Take all necessary safety measures to ensure that water damage to the traction battery, EV system or other components does not occur.

- Water entering the motor compartment may cause severe damage to the EV system.
- Water entering the transmission will cause deterioration in transmission quality. The malfunction indicator may come on, and the vehicle may not be drivable.
- Water can wash the grease from wheel bearings, causing rusting and premature failure, and may also enter the transaxle case, reducing the gear oil's lubricating qualities.

■ **When you drive through water**

If driving through water, such as when crossing shallow streams, first check the depth of the water and the bottom of the riverbed for firmness. Drive slowly and avoid deep water.

■ **Inspection after off-road driving**

- Sand and mud that has accumulated around brake discs may affect braking efficiency and may damage brake system components.
- Always perform a maintenance inspection after each day of off-road driving that has taken you through rough terrain, sand, mud, or water. For scheduled maintenance information, refer to the "Scheduled Maintenance Guide" or "Owner's Manual Supplement".

Interior features**6****6-1. Using the air conditioning system and defogger**

ALL AUTO (“ECO”) control
 400

Automatic air conditioning
 system..... 402

Remote Air Conditioning
 System 409

Heated steering wheel/seat
 heaters/seat ventila-
 tors/radiant heater 411

6-2. Using the interior lights

Interior lights list 415

6-3. Using the storage features

List of storage features 418

Luggage compartment fea-
 tures 421

6-4. Using the other interior features

Electronic sunshade.... 426

Other interior features. 428

Garage door opener.... 439

ALL AUTO (“ECO”) control

The seat heaters^{*}, seat ventilators^{*} and heated steering wheel^{*} are each automatically controlled according to the set temperature of the air conditioning system, the outside and cabin temperature, etc. ALL AUTO (“ECO”) controls the power consumption in order to both extend the cruising range and maintain comfortable conditions.

*: if equipped

Turning on ALL AUTO (“ECO”) control

Press the ALL AUTO (“ECO”) switch

The indicator on the ALL AUTO (“ECO”) switch illuminates, and the automatic air conditioning system, seat heaters^{*} and ventilators^{*}, and heated steering wheel^{*} operate in automatic mode.

If any of the system is operated manually, the indicator turns off. However, all other functions continue to operate in automatic mode.

Even if ALL AUTO (“ECO”) control is turned off, the air conditioner, seat heater/ventilator, and steering heater will not be turned off.

If the front window glass becomes

cloudy due to a drop in the outside air temperature while the ALL AUTO (“ECO”) control is operating, you can remove the cloudiness by pressing the AUTO switch on the air conditioner control panel.

*: If equipped

Operation of each system

■ Automatic air conditioning system (→P.402)

The temperature can be adjusted independently for each seat.

■ Seat heaters (if equipped) and ventilators (if equipped) (→P.411)

Heating or ventilation is automatically selected according to the set temperature of the air conditioning system, the outside temperature, etc.

■ Heated steering wheel (if equipped) (→P.411)

Heated steering wheel operates automatically according to the set temperature of the air conditioning system, the outside temperature, etc.

■ Passenger detection functions

When a passenger is detected in the front passenger seat, the seat heater and ventilator will operate automatically.

■ Seat heater (if equipped)/ventilator (if equipped) operation

If the seat heater/ventilator switch is set to auto, it will operate without performing the passenger detection.

When the ALL AUTO (“ECO”) switch is pressed in that state, the passenger seat heater and ventilator will operate according to that passenger detected state.

■ **Rear seat heater (if equipped) operation**

The rear seat heaters are not controlled by the ALL AUTO (“ECO”) control.

Automatic air conditioning system

Air outlets and fan speed are automatically adjusted according to the temperature setting.

Air conditioning controls

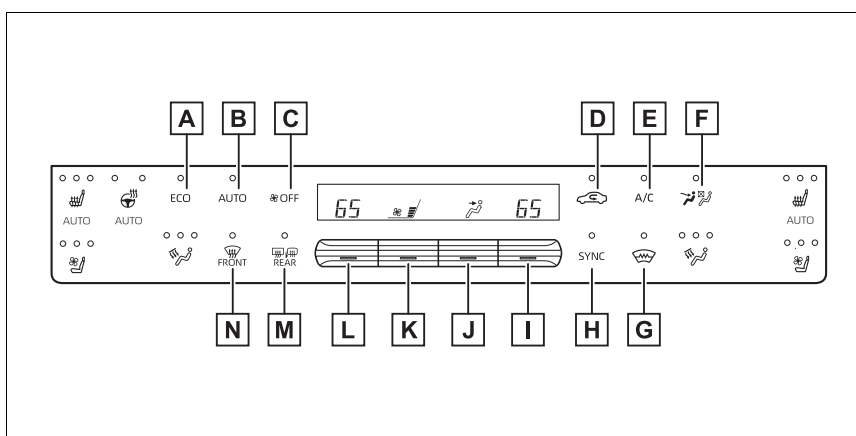

- A** ALL AUTO (“ECO”) switch (→P.400)
- B** Automatic mode switch
- C** “OFF” switch
- D** Outside/recirculated air mode switch
- E** “A/C” switch
- F** Front seat concentrated airflow mode (S-FLOW) switch
- G** Windshield wiper de-icer switch (if equipped)
- H** “SYNC” switch
- I** Right-hand side temperature control switch
- J** Airflow mode control switch
- K** Fan speed control switch
- L** Left-hand side temperature control switch
- M** Rear window and outside rear view mirror defogger switch
- N** Windshield defogger switch

■ Adjusting the temperature setting

Operate the temperature control switch upwards to increase the temperature and downwards to decrease the temperature.

If "A/C" is not pressed, the system will blow ambient temperature air or heated air.

■ Setting the fan speed

Operate the fan speed control switch upwards to increase the fan speed and downwards to decrease the fan speed.

Press the "OFF" switch to turn off the fan.

■ Change the airflow mode

Operate the airflow mode control switch upwards or downwards.

The mode changes as follows each time the switch is operated.

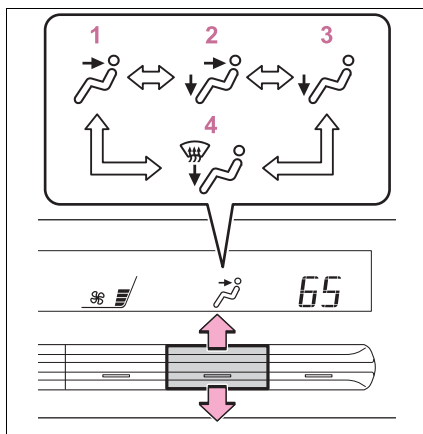

- 1 Air flows to the upper body.
- 2 Air flows to the upper body and feet.

- 3 Air flows to the feet.
- 4 Air flows to the feet and the windshield defogger operates.

■ Switching between outside air and recirculated air modes

Press the outside/recirculated air mode switch.

The mode switches between outside air mode (the indicator is off) and recirculated air mode (the indicator is on) each time the switch is pressed.

■ Set cooling and dehumidification function

Press the "A/C" switch.

When the function is on, the indicator illuminates on the "A/C" switch.

■ Defogging the windshield

Defoggers are used to defog the windshield and front side windows.

Press the windshield defogger switch.

Set the outside/recirculated air mode switch to outside air mode if the recirculated air mode is used. (It may switch automatically.)

To defog the windshield and the side windows quickly, turn the air flow and temperature up.

To return to the previous mode, press the windshield defogger switch again when the windshield is defogged.

When the windshield defogger switch is on, the indicator illuminates on the windshield defogger switch.

■ **Defogging the rear window and outside rear view mirrors**

Defoggers are used to defog the rear window and to remove raindrops, dew and frost from the outside rear view mirrors.

Press the rear window and outside rear view mirror defogger switch.

The defoggers will automatically turn off after a period of time.

■ **Windshield wiper de-icer (if equipped)**

This feature is used to prevent ice from building up on the windshield and wiper blades.

Press the windshield wiper de-icer switch.

The indicator **A** comes on when the windshield wiper de-icer is on.

The windshield wiper de-icer will automatically turn off after a period of time.

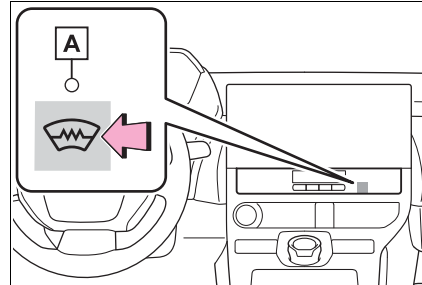

■ **Fogging up of the windows**

● The windows will easily fog up when the humidity in the vehicle is high. Turning “A/C” switch on will dehumidify the air from the outlets and defog the windshield effectively.

● If you turn “A/C” switch off, the windows may fog up more easily.

● The windows may fog up if the recirculated air mode is used.

■ **When driving on dusty roads**

Close all windows. If dust thrown up by the vehicle is still drawn into the vehicle after closing the windows, it is recommended that the air intake mode be set to outside air mode and the fan speed to any setting except off.

■ **Outside/recirculated air mode**

● Setting to the recirculated air mode temporarily is recommended in preventing dirty air from entering the vehicle interior and helping to cool the vehicle when the outside air temperature is high.

● Outside/recirculated air mode may automatically switch depending on the temperature setting or the inside temperature.

■ **When the outside temperature exceeds 75°F (24°C) and the air conditioning system is on**

● In order to reduce the air conditioning power consumption, the air conditioning system may switch to

recirculated air mode automatically. This may also reduce electricity consumption.

- Recirculated air mode is selected as a default mode when the power switch is turned to ON.
- It is possible to switch to outside air mode at any time by pressing the outside/recirculated air mode switch.

■ **When the outside temperature falls to nearly 32°F (0°C)**

The dehumidification function may not operate even when “A/C” switch is pressed.

■ **Ventilation and air conditioning odors**

- To let fresh air in, set the air conditioning system to the outside air mode.
- During use, various odors from inside and outside the vehicle may enter into and accumulate in the air conditioning system. This may then cause odor to be emitted from the vents.
- To reduce potential odors from occurring:
 - It is recommended that the air conditioning system be set to outside air mode prior to turning the vehicle off.
 - The start timing of the blower may be delayed for a short period of time immediately after the air conditioning system is started in automatic mode.
- When parking, the system automatically switches to outside air mode to encourage better air circulation throughout the vehicle, helping to reduce odors that occur when starting the vehicle.

■ **Air conditioning filter**

→P.494

■ **Air conditioning system refrigerant**

- A label regarding the refrigerant of

the air conditioning system is attached to the hood at the location shown in the following illustration.

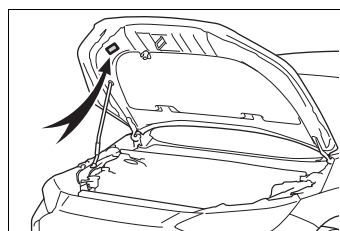

- The meaning of each symbol on the label are as follows:

| | |
|--|---|
| | Caution |
| | Air conditioning system |
| | Air conditioning system lubricant type |
| | Requires registered technician to service air conditioning system |
| | Flammable refrigerant |

■ **Noise from air conditioning system**

Approximately 90 seconds after the power switch turned to OFF, you may hear sound coming from air conditioning system. This is the sound of a air conditioning system initialize and, it does not indicate a malfunction.

■ **Customization**

Some functions can be customized. (Customizable features: →P.575)

 **WARNING**

■ **To prevent the windshield from fogging up**

Do not use the windshield defogger switch during cool air operation in extremely humid weather. The difference between the temperature of the outside air and that of the windshield can cause the outer surface of the windshield to fog up, blocking your vision.

■ **To prevent burns**

- Do not touch the rear view mirror surfaces when the outside rear view mirror defoggers are on.
- Vehicles with windshield wiper de-icer: Do not touch the glass at lower part of the windshield or to the side of the front pillars when the windshield wiper de-icer is on.

 **NOTICE**

■ **To prevent 12-volt battery discharge**

Do not leave the air conditioning system on longer than necessary when the EV system is off.

■ **When repairing/replacing parts of the air conditioning system**

Have repair/replacement performed by your Toyota dealer. When a part of the air conditioning system, such as the evaporator, is to be replaced, it must be replaced with a new one.

Using automatic mode

- 1 Press the automatic mode switch.

The dehumidification function

begins to operate. Air outlets and fan speed are automatically adjusted according to the temperature setting and humidity.

- 2 Adjust the temperature setting.
- 3 To stop the operation, press the "OFF" switch.

If the fan speed setting or air flow modes are operated, the automatic mode indicator goes off. However, automatic mode for functions other than that operated is maintained.

■ **Using automatic mode**

Fan speed is adjusted automatically according to the temperature setting and the ambient conditions.

Therefore, the fan may stop for a while until warm or cool air is ready to flow immediately after the automatic mode switch is pressed.

Adjusting the temperature for driver and front passenger seats separately ("SYNC" mode)

To turn on the "SYNC" mode, perform any of the following procedures:

- Press the "SYNC" mode switch.
- Adjust the front passenger's side temperature setting.

The indicator comes on when the "SYNC" mode is on.

Air outlet layout and operations

■ **Location of air outlets**

The air outlets and air volume change according to the selected air flow mode.

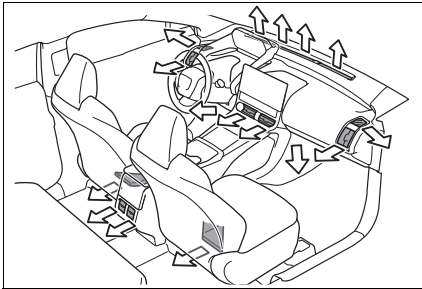

■ **Adjusting the air flow direction and opening/closing the air outlets**

► **Front**

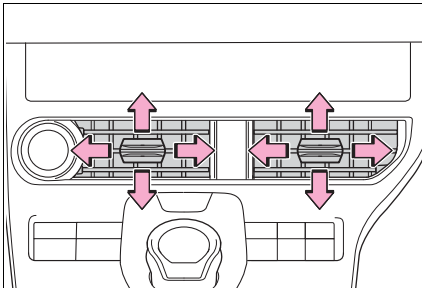

Direct air flow to the left or right, up or down

Move the knob fully to the outside to close the vent.

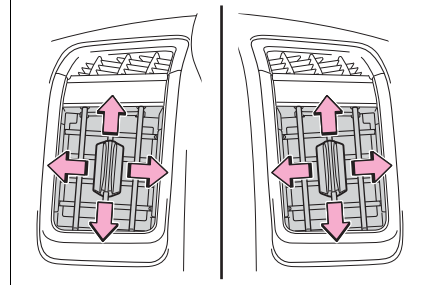

Direct air flow to the left or right, up or down

Move the knob fully downward to close the vent.

► **Rear**

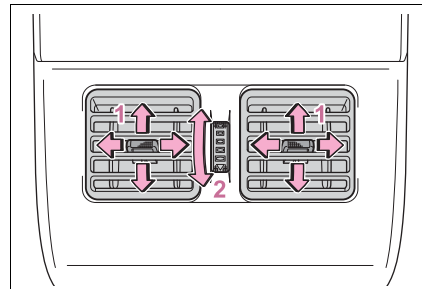

1 Direct air flow to the left or right, up or down

2 Turn the knob to open or close the vent

⚠ WARNING

■ **To not interrupt the windshield defogger from operating**

Do not place anything on the instrument panel which may cover the air outlets. Otherwise, air flow may be obstructed, preventing the windshield defoggers from defogging.

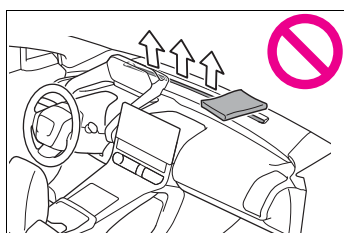

Front seat concentrated airflow mode (S-FLOW)

This function automatically controls the air conditioning airflow so that priority is given to the front seats. Unnecessary air conditioning is suppressed, contributing to increased electricity consumption efficiency.

Front seat concentrated airflow mode operates in the following situations.

- No passengers are detected in the rear seats
- The windshield defogger is not operating

While operating,  illuminates.

■ **Manually turning front seat concentrated airflow mode on/off**

In front seat concentrated airflow mode, directing airflow to the front seats only and to all seats can be switched via switch operation. When the mode has been switched manually, automatic airflow control stops operating.

Press  on the air conditioning operation panel and switch the airflow.

- Indicator illuminated: Airflow to the front seats only
- Indicator off: Airflow to all the seats

■ **Operation of automatic airflow control**

- In order to maintain a comfortable interior, airflow may be directed to seats without passengers immediately after the EV system is started and at other times depending on the outside temperature.
- After the EV system is started, if passengers move around inside or enter/exit the vehicle, the system cannot accurately detect the presence of passengers and automatic airflow control will not operate.

■ **Operation of manual airflow control**

Even if the function is manually switched to directing airflow to only the front seats, when a rear seat is occupied, it may automatically direct airflow to all seats.

■ To return to automatic airflow control

- 1 With the indicator off, turn the power switch off.
- 2 After 60 minutes or more elapse, turn the power switch to ON.

Remote Air Conditioning System

The Remote Air Conditioning System uses electrical energy stored in the traction battery and allows the air conditioning to be operated by remote control.

If the Remote Air Conditioning System is used while the charging cable is connected to the vehicle, the reduction of charge in the traction battery will be suppressed to allow you to use electricity from an external power source.

Charging will be conducted automatically after the Remote Air Conditioning System is stopped.

Before leaving the vehicle

Check the temperature setting of the air conditioning system. (→P.403)

The Remote Air Conditioning System will operate in accordance with the temperature settings of the air conditioning system.

Activating the Remote Air Conditioning System

Press and hold "A/C" on the wireless remote control to operate the Remote Air Conditioning

System.

The system will shut off if a door is opened.

The system can be stopped by pressing "A/C" twice.

► **Type A**

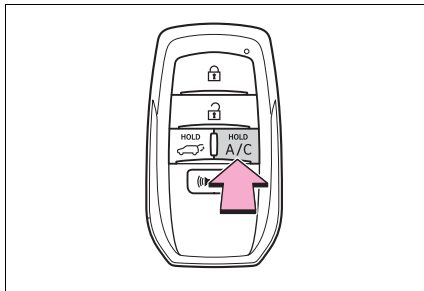

► **Type B**

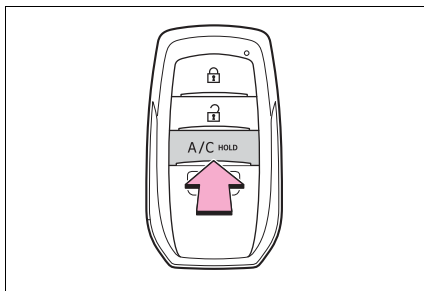

■ **Operating conditions**

The system will only operate if all of the following conditions are met:

- The power switch is OFF.
- All doors are closed.
- The hood is closed.

■ **Remote Air Conditioning System automatic shut-off**

The system will automatically shut off under the following conditions:

- About 20 minutes have passed since operation began
- Any one of the operating conditions is not met

The system may also shut off if the charge level of the traction battery

drops to low.

■ **Conditions affecting operation**

The system may not start in the following situations:

- The charge level of the traction battery is low
- When the EV system is cool (for example, after being left for a long time in low temperatures)

■ **Windshield defogger**

When defogging the windshield using the Remote Air Conditioning System, defogging may be insufficient due to the power being restricted more than during normal air conditioning operation. Also, the outside of the windshield may fog up due to the outside temperature, humidity or air conditioning set temperature.

■ **Security feature**

Any unlocked doors will be automatically locked when the system is operating. The emergency flashers flash to indicate that the doors have been locked.

■ **Conditions affecting operation**

→P.188

■ **While the Remote Air Conditioning System is operating**

- Depending on the operating condition of the Remote Air Conditioning System, the electric fan may spin and an operating noise may be heard. However, this does not indicate a malfunction.
- The Remote Air Conditioning System may stop operating temporarily if other features that use electricity (for example, the seat heater, lights, windshield wipers) are in operation or if the charge level of the 12-volt battery becomes low.
- The headlights, windshield wiper, meter, etc. will not operate.

■ **Electronic key battery depletion**

→P.162

■ **When the electronic key battery is fully depleted**

→P.497

■ **Customization**

Setting (e.g. Operation using “A/C” on the wireless remote control) can be changed. (Customizable features: →P.575)

 **WARNING**

■ **Precautions for the Remote Air Conditioning System**

- Do not use the system if people are in the vehicle. Even when the system is in use, the internal temperature may still reach a high or low level due to features such as the automatic shut-off. Children and pets left inside the vehicle may suffer heatstroke dehydration or hypothermia, or could result in death or serious injury.
- Depending on the surrounding environment, signals from the wireless switch may transmit further than expected. Pay appropriate attention to the vehicle’s surroundings and use the switch only when necessary.
- Do not operate “A/C” if the hood is open. The air conditioning may operate unintentionally and objects may be drawn into the electrical cooling fan.

 **NOTICE**

■ **To prevent the traction battery from being discharged through incorrect operation**

Use “A/C” only when necessary.

Heated steering wheel^{*}/seat heaters^{*}/seat ventilators^{*}/radiant heater^{*}

*: If equipped

● **Heated steering wheel**

Warms up the grip of the steering wheel

● **Seat heaters**

Warm up the seat upholstery

● **Seat ventilators**

Maintain good airflow on the seat upholstery by sucking air into the seats

● **Radiant heaters**

Warm up the feet of the front seats

 **WARNING**

■ **To prevent minor burn injuries**

Care should be taken if anyone in the following categories comes in contact with the steering wheel or seats when the heater is on:

- Babies, small children, the elderly, the sick and the physically challenged
- Persons with sensitive skin
- Persons who are fatigued
- Persons who have taken alcohol or drugs that induce sleep (sleeping drugs, cold remedies, etc.)

 NOTICE

■ **To prevent damage to the seat heaters and seat ventilators**

Do not put heavy objects that have an uneven surface on the seat and do not stick sharp objects (needles, nails, etc.) into the seat.

■ **To prevent 12-volt battery discharge**

Do not use the functions when the EV system is off.

Heated steering wheel

Turns the heated steering wheel on/off

Each time the switch is pressed, the operation condition changes as follows.

AUTO (lit) → Hi (2 segments lit) → Lo (1 segment lit) → Off

The AUTO indicator **A** and/or level indicator **B** illuminates during operation.

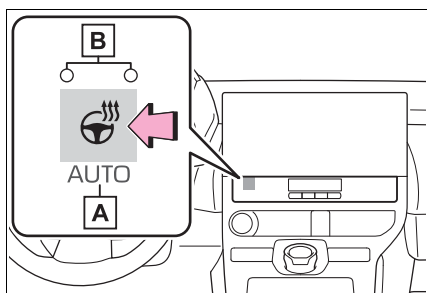

■ **The heated steering wheel can be used when**

The power switch is in ON.

Seat heaters

■ **Front**

Turns the seat heaters on/off

Each time the switch is pressed, the operation condition changes as follows.

AUTO (lit) → Hi (3 segments lit) → Mid (2 segments lit) → Lo (1 segment lit) → Off

The AUTO indicator **A** and/or level indicator **B** illuminates during operation.

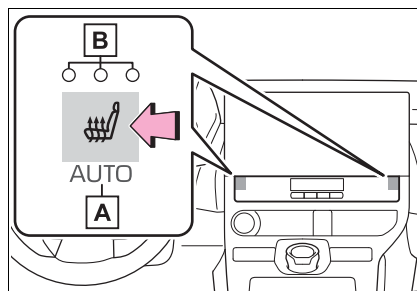

■ **Rear (outboard rear seats)**

Each time the switch is pressed, the operation condition changes as follows.

Hi (3 segments lit) → Mid (2 segments lit) → Lo (1 segment lit) → Off

When not in use, put the switch in the neutral position. The indicator **A** will turn off.

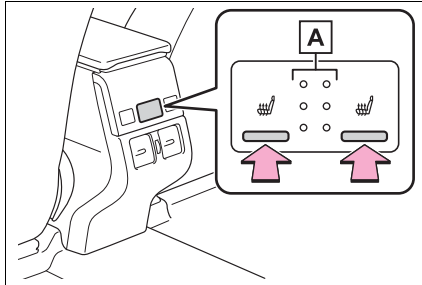

■ **The seat heaters can be used when**

The power switch is in ON.

⚠ WARNING

■ **To prevent causes of overheating and minor burn injuries**

Observe the following precautions when using a seat heater

- Do not cover the seat with a blanket or cushion when using the seat heater.
- Do not use seat heater more than necessary.

Seat ventilators (front seats)

Turns the seat ventilators on/off

Each time the switch is pressed, the operation condition changes as follows.

AUTO (lit) → Hi (3 segments lit) → Mid (2 segments lit) → Lo (1 segment lit) → Off

The AUTO indicator **A** and/or level indicator **B** illuminates during operation.

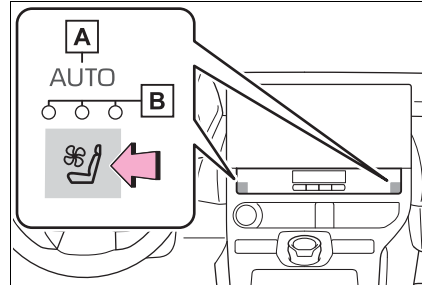

■ **The seat ventilators can be used when**

The power switch is in ON.

■ **Air conditioning system-linked control mode**

When the seat ventilator fan speed level is Hi, the seat ventilator fan speed becomes higher according to the fan speed of the air conditioning system.

Radiant heaters

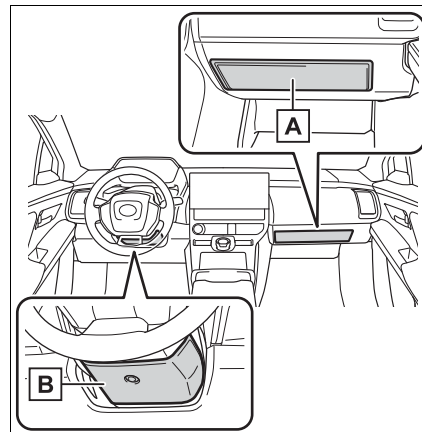

A Front passenger's side radiant heater

B Driver's side radiant heater

Turns the radiant heater on/off

Each time the switch is pressed, the operation condition changes as

414 6-1. Using the air conditioning system and defogger

follows.

Hi (3 segments lit) → Mid (2 segments lit) → Lo (1 segment lit) → Off

The level indicator **A** illuminates during operation.

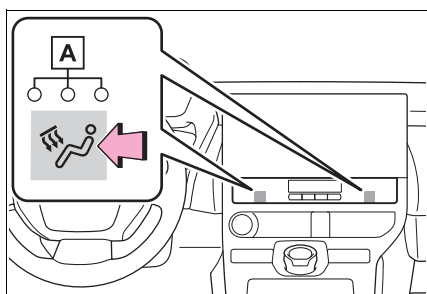

■ The radiant heater can be used when

The power switch is in ON.

- The power may be turned off automatically by continually touching the heater section. In that case, turn the radiant heater switch on again.
- It may take some time for the heater temperature to rise.

⚠ WARNING

■ To prevent causes of overheating and minor burn injuries

Observe the following precautions when using a radiant heater

- Do not use radiant heater more than necessary.
- Do not let blankets, cushions, luggage, etc., to touch the radiant heater. Do not use.

■ Use while driving

Do not touch the radiant heater or hold your hand or foot over it by releasing a hand from the handle or a foot from the pedal.

Doing so may cause the driver to mishandle the vehicle and cause an accident, resulting in death or serious injury.

⚠ NOTICE

■ To prevent damage to the radiant heater

Do not pierce with uneven objects or sharp objects such as wires or needles.

Interior lights list

Location of the interior lights

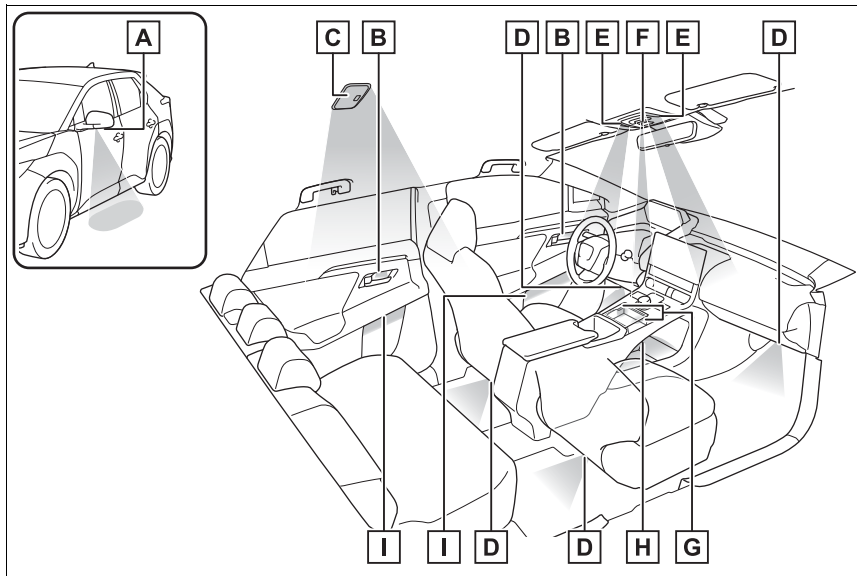

- A** Outer foot lights (if equipped)
- B** Inside door handle lights (if equipped)
- C** Rear interior light (→P.416)
- D** Footwell lights (if equipped)
- E** Front interior lights/personal lights (→P.416, 417)
- F** Shift lights
- G** Auxiliary box lights (if equipped)/Wireless charger tray lights (if equipped)
- H** Center console light (if equipped)
- I** Door trim ornament lights (if equipped)

■ **Personal lights/interior lights automatic on/off**

- Illuminated entry system: The lights automatically turn on/off according to power switch mode,

the presence of the electronic key, whether the doors are locked/unlocked, and whether the doors are opened/closed.

- If the interior lights remain on when the power switch is turned

off, the lights will go off automatically after 20 minutes.

■ **The interior lights will turn on automatically when**

If any of the SRS airbags deploy (inflate) or in the event of a strong rear impact, the interior lights will turn on automatically. The interior lights will turn off automatically after approximately 20 minutes.

The interior lights can be turned off manually. However, in order to help prevent further collisions, it is recommended that they be left on until safety can be ensured.

(The interior lights may not turn on automatically depending on the force of the impact and conditions of the collision.)

■ **Customization**

Setting (e.g. the time elapsed before the lights turn off) can be changed. (Customizable features: →P.575)

| | |
|---|----------------------|
|  | <p>NOTICE</p> |
| <p>■ To prevent 12-volt battery discharge</p> | |
| <p>Do not leave the lights on longer than necessary when the EV system is off.</p> | |

Operating interior lights

■ **Front interior lights**

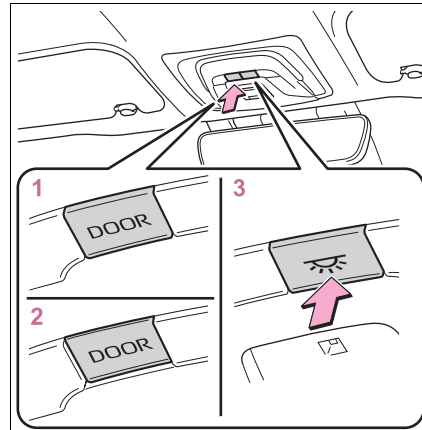

1 Turns the door-linked function off

2 Turns the door-linked function on (door position)

The lights turn on/off according to the opening/closing of the doors.

3 Turns the lights on/off

Press the switch to turn on/off the front interior lights/personal lights and rear interior lights.

■ **Rear interior light**

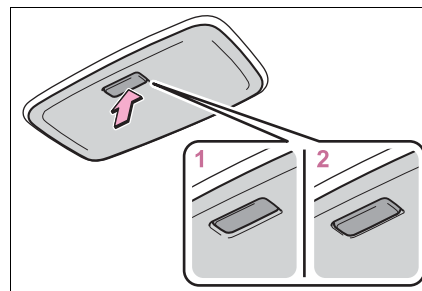

1 Turns the light on

2 Turns the door-linked function on (door position)

The light turns on/off according to

the opening/closing of the doors.
The rear interior light turn on/off
together the front interior light.

Operating personal lights

Turns the lights on/off

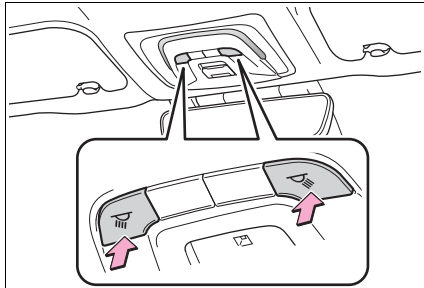

List of storage features

Location of the storage features

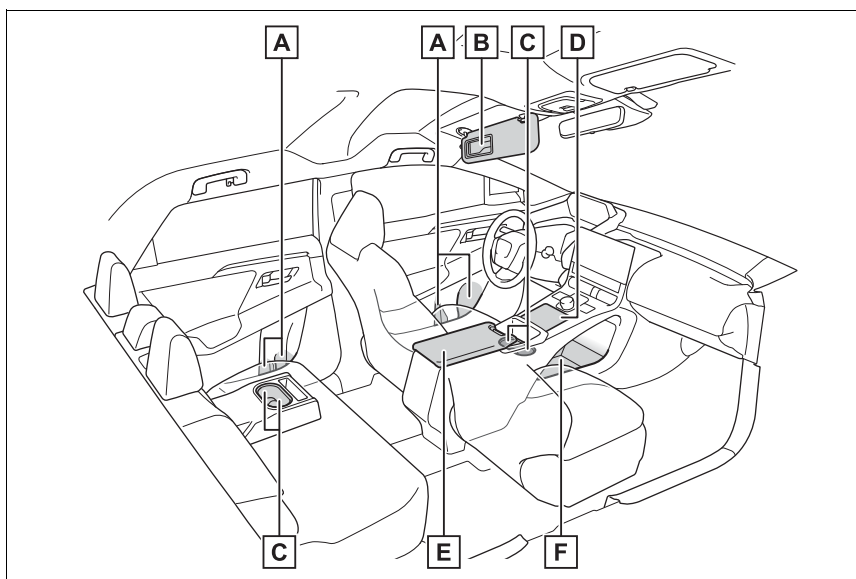

- A** Bottle holders (→P.420)
- B** Card holders (→P.420)
- C** Cup holders (→P.419)
- D** Auxiliary box (if equipped) (→P.420)
- E** Console box (→P.419)
- F** Open tray (→P.420)

⚠ WARNING

■ Items that should not be left in the vehicle

Do not leave glasses, lighters or spray cans in the storage spaces, as this may cause the following when cabin temperature becomes high:

- Glasses may be deformed by heat or cracked if they come into contact with other stored items.
- Lighters or spray cans may explode. If they come into contact with other stored items, the lighter may catch fire or the spray can may release gas, causing a fire hazard.

Console box

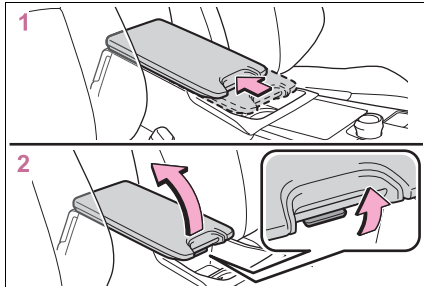

- 1** Slide the lid as backward.
- 2** Lift the lid while pulling the lever to release the lock.

■ **Console box lid**

The lid can be slide forward/backward.

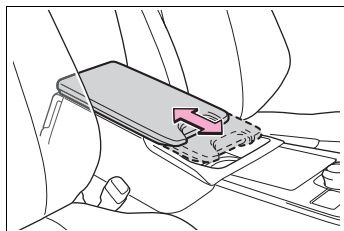

■ **Tray within console box**

The tray can be removed by lifting the tray it out.

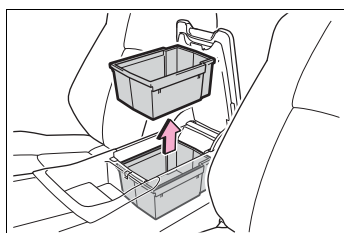

! WARNING

■ **Caution while driving**

Keep the console box closed. Injuries may result in the event of an accident or sudden braking.

! NOTICE

■ **To prevent damage to the console box**

Do not apply excessive force to the armrest.

Cup holders

■ **Front**

Slide the lid as backward.

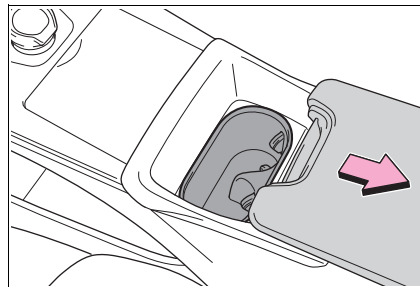

■ **Rear**

Pull down the armrest.

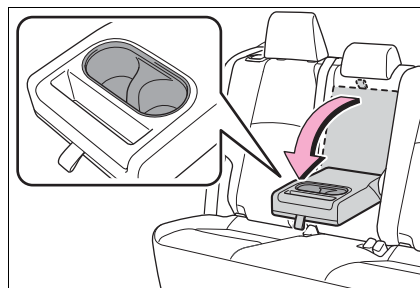

! WARNING

■ **Items unsuitable for the cup holders**

Do not place anything other than cups or aluminum cans in the cup holders.

Other items may be thrown out of the holders in the event of an accident or sudden braking, causing injury. If possible, cover hot drinks to prevent burns.

Bottle holders

■ Front

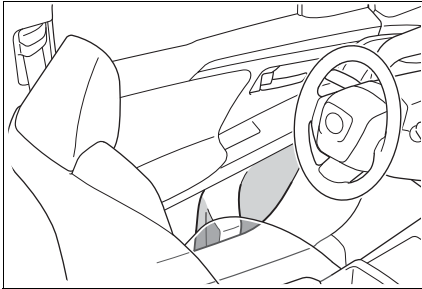

■ Rear

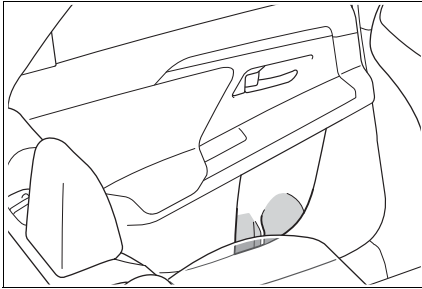

■ Bottle holders

- When storing a bottle, close the cap.
- The bottle may not be stored depending on its size or shape.



NOTICE

■ Items that should be not stowed in the bottle holders

Do not place open bottles or glass and paper cups containing liquid in the bottle holders. The contents may spill and glasses may break.

Card holders

Flip down the visor.

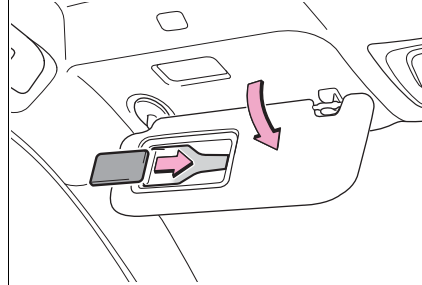

Auxiliary box (Vehicles without wireless charger)

Press the lid to open the auxiliary box.

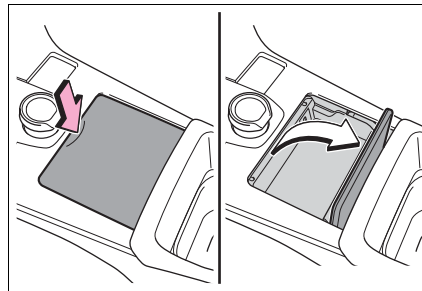

Open tray

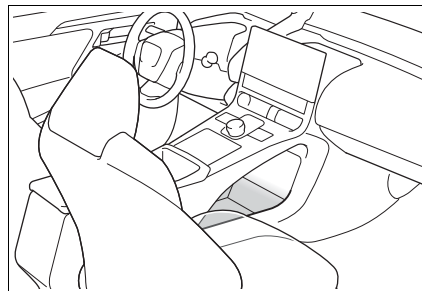

⚠ WARNING

■ **Caution while driving**

Observe the following precautions when putting items in the open tray. Failure to do so may cause items to be thrown out of the tray in the event of sudden braking or steering. In these cases, the items may interfere with pedal operation or cause driver distraction, resulting in an accident.

- Do not store items in the tray that can easily shift or roll out.
- Do not stack items in the tray higher than the edge of tray.
- Do not put items in the tray that may protrude over the edge of tray.

Luggage compartment features

Cargo hooks

Raise the hooks to use.
The cargo hooks are provided for securing loose items.

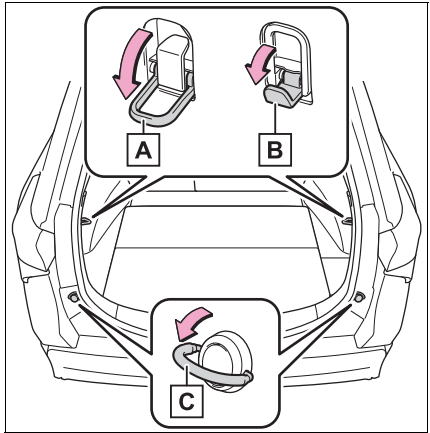

- A** Upper hook (rope hook)
- B** Upper hook (utility hook)
- C** Lower hook

⚠ WARNING

■ **When cargo hooks are not in use**

To avoid injury, always return the hooks to their stowed positions when not in use.

⚠ NOTICE

■ **To prevent damage to the upper hook (utility hook)**

Do not hang any object heavier than 8 lb. (4 kg) on the upper hook (utility hook).

Deck board

■ **Changing the deck board positions**

Height of the deck floor can be changed by setting the deck board under the floor.

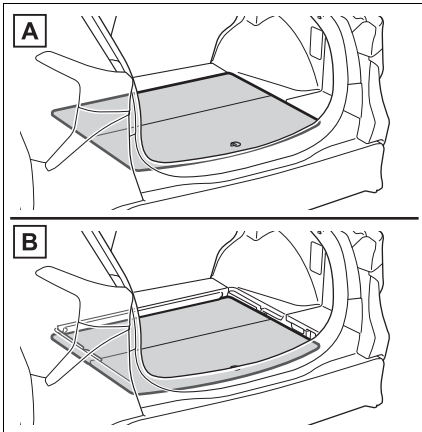

A Upper

B Lower

- 1 Pull up the tab to raise the deck board and move it toward you to remove.

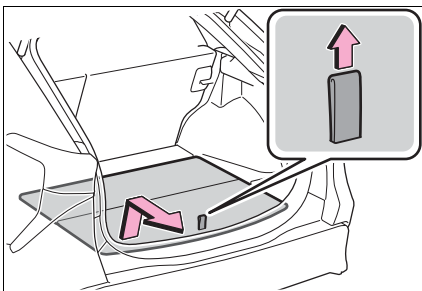

- 2 Place the deck board through the groove and move forward.

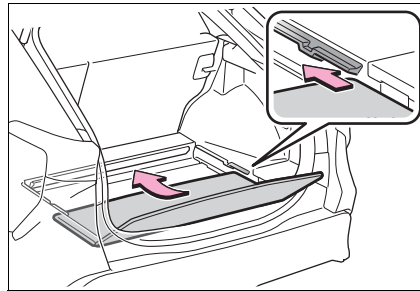

■ **Setting the deck board upright**

When taking out the tools, the deck board can be set upright.

When the back surface (resin surface) of the deck board is facing up, flip it back to the original position.

- 1 Pull up the tab to raise the deck board and fold it forward.

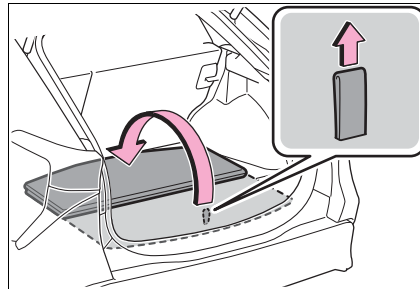

- Deck board in a standing state, put the edge into the holes.

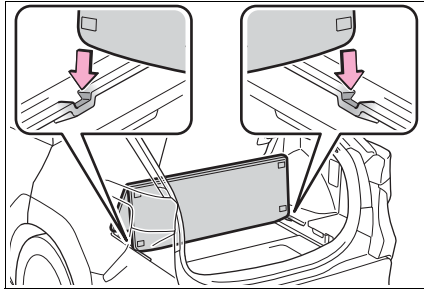

⚠ WARNING

- **When operating the deck board**
Do not place anything on the deck board when operating the board. Otherwise, your fingers may be caught or an accident may result causing injuries.
- **Caution while driving**
Keep the deck board closed. In the event of sudden braking, an accident may occur due to an occupant being struck by the deck board or the items stored under the deck board.

Deck under tray

Pull up the tab to raise the deck board and fold it forward.

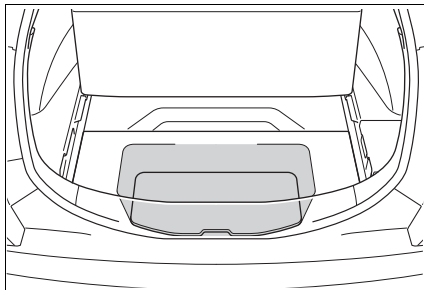

⚠ WARNING

- **Caution while driving**
Keep the deck board closed. In the event of sudden braking, an accident may occur due to an occupant being struck by the deck board or the items stored under the deck board.

■ **Warning reflector**
Depending on the size and shape of the warning reflector case, you may not be able to store it.

Luggage cover (if equipped)

- **Removing the luggage cover unit**
 - Pull up the tab to raise the deck board and fold it forward. (→P.422)
 - Take out the luggage cover unit.

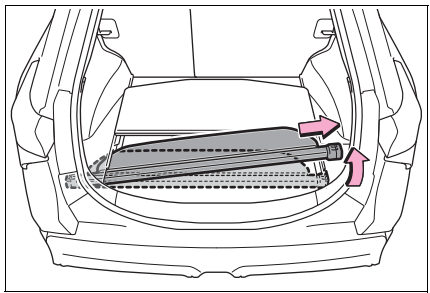

■ **Installing the luggage cover**

- 1 Compress the both ends of the luggage cover and insert into the recess to install.

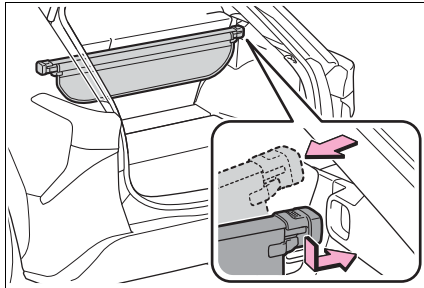

- 2 Pull out the luggage cover and hook it onto the anchors.

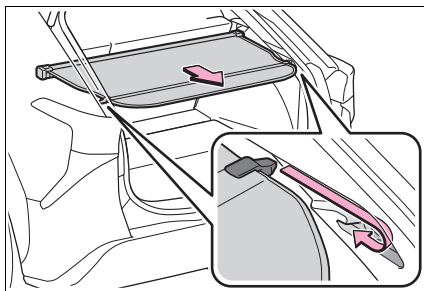

■ **Removing the luggage cover**

- 1 Release the cover from the left and right anchors and allow it to retract.

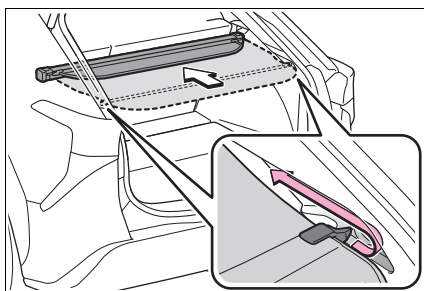

- 2 Compress the end of the luggage cover and lift the luggage cover up.

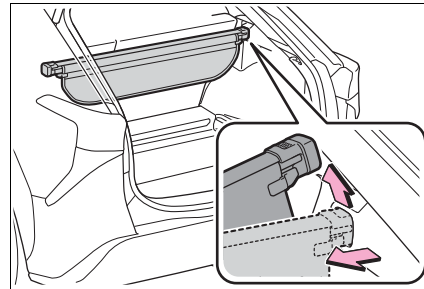

■ **Stowing the luggage cover unit**

- 1 Pull up the tab to raise the deck board and fold it forward. (→P.422)
- 2 To store the luggage cover unit, compress both ends until they lock.

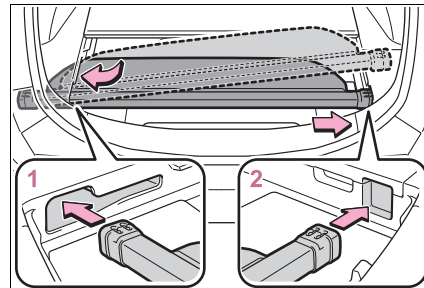

- 1 Insert the left end of the luggage cover unit into the groove on the left side of the deck.
- 2 Insert the right end of the luggage cover unit into the groove on the right side of the deck.



WARNING

■ **Luggage cover**

- When installing/stowing the luggage cover, make sure that the luggage cover is securely installed/stowed. Failure to do so may result in serious injury in the event of sudden braking or a collision.
- Do not place anything on the luggage cover. In the event of sudden braking or turning, the item may go flying and strike an occupant. This could lead to an unexpected accident, resulting in death or serious injury.
- Do not allow children to climb on the luggage cover. Climbing on the luggage cover could result in damage to the luggage cover, possibly causing death or serious injury to the child.

Electronic sunshade*

*: If equipped

Use the overhead switches to operate the electronic sunshade.

Operating the electronic sunshade

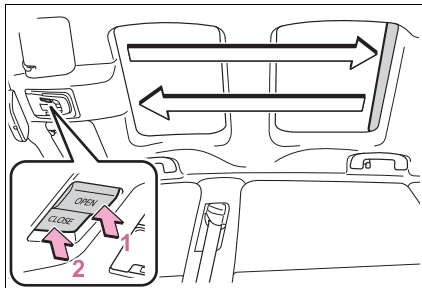

- 1 Open*
- 2 Close*

*: To stop the electronic sunshade partway, lightly press the either end of the switch.

■ The electronic sunshade can be operated when

The power switch is in ON.

■ Jam protection function for the electronic sunshade

- If an object becomes jammed between the electronic sunshade and the sunshade frame while the electronic sunshade is closing, the electronic sunshade movement is stopped and the electronic sunshade is opened slightly.
- When the jam protection function has operated, even if the “CLOSE” side of the switch is pressed again, the electronic sunshade will not move in the close direction until the reverse opera-

tion has stopped completely.

- The electronic sunshade may operate in reverse if the electronic sunshade is subject to an impact due to the surroundings or the driving conditions.

■ When the electronic sunshade does not close normally

Perform the following initialization procedure.

- 1 Turn the power switch to ON.
- 2 Press and hold the “CLOSE” side of the switch.

It closes until it is near the fully closed position and then stops. After that, it operates in the opening direction then closes to the fully closed position.

If the switch is released at the incorrect time, the procedure will have to be performed again from the beginning.

If the automatic opening and closing function does not work normally even after performing the operations above, have the vehicle inspected by your Toyota dealer.

⚠ WARNING

Observe the following precautions. Failure to do so may result in death or serious injury.

⚠ WARNING**■ Opening and closing the electronic sunshade**

- Check to make sure that all passengers do not have any part of their body in a position where it could be caught when the electronic sunshade is being operated.

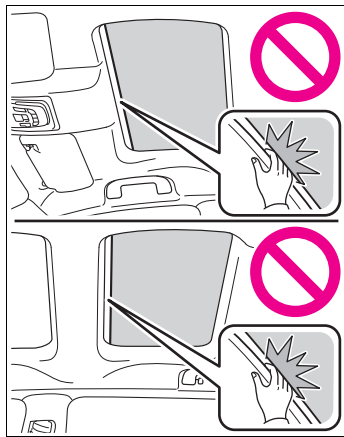

- Do not let a child operate the electronic sunshade. Closing the electronic sunshade on someone can cause death or serious injury.

■ Jam protection function

- Never use any part of your body to intentionally activate the jam protection function.
- The jam protection function may not work if something gets caught just before the electronic sunshade is fully closed. Also, the jam protection function is not designed to operate while the switch is being pressed. Take care so that your fingers, etc., do not get caught.

■ To prevent burns or injuries

Do not touch the area between the underside of the glass roof and the electronic sunshade. Your hand may get caught and you could injure yourself. Also, if the vehicle is left in direct sunlight for a long time, the underside of the panoramic moon roof could become very hot and could cause burns.

Other interior features

Sun visors

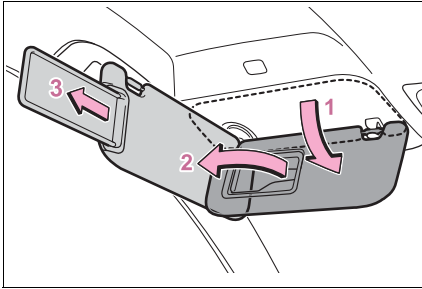

- 1 To set the visor in the forward position, flip it down.
- 2 To set the visor in the side position, flip down, unhook, and swing it to the side.
- 3 To use the side extender (if equipped), place the visor in the side position, then slide it backward.

Vanity mirrors

Slide the cover to open.

The light turns on when the cover is opened.

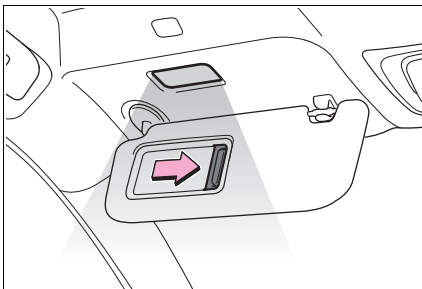

■ **Vanity lights**

If the vanity lights remain on when the power switch is turned off, the

lights will go off automatically after 20 minutes.

 **NOTICE**

■ **To prevent 12-volt battery discharge**

Do not leave the vanity lights on for extended periods while the EV system is off.

Power outlet

Please use a power supply for electronic goods that use less than 12 VDC /10 A (power consumption of 120 W).

When using electronic goods, make sure that the power consumption of all the connected power outlets is less than 120 W.

Open the lid.

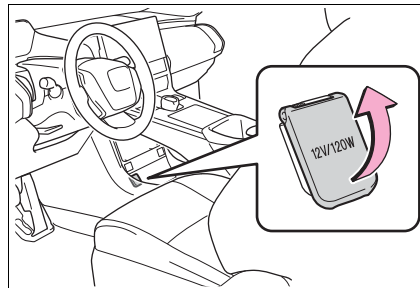

■ **The power outlet can be used when**

The power switch is in ACC or ON.

■ **When stopping the EV system**

Disconnect electrical devices with charging functions, such as mobile battery packs.

If such devices are left connected, the EV system may not stop normally.

 **NOTICE**

■ **When power outlet is not in use**

To avoid damaging the power outlet, close the power outlet lid when the power outlet is not in use.
Foreign objects or liquids that enter the power outlet may cause a short circuit.

■ **To prevent 12-volt battery discharge**

Do not use the power outlet longer than necessary when the EV system is off.

■ **To prevent incorrect operation of the vehicle**

When turning the power switch off, make sure to disconnect accessories designed for charging, such as portable chargers, power banks, etc. from the power outlets.

If such an accessory is left connected, the following may occur:

- The doors will not be able to be locked.
- The opening screen will be displayed on the multi-information display.
- The interior lights, instrument panel lights, etc. will illuminate.

USB Type-C charging ports

The USB Type-C charging ports are used to supply 3 A of electricity at 5 V to external devices. The USB Type-C charging ports are for charging only. They are not designed for data transfer or other purposes.

Depending on the external device, it may not charge properly. Refer to the manual included with the device before using a USB charging port.

Refer to “MULTIMEDIA OWNER’S MANUAL” for USB Type-A information.

■ **Using the USB Type-C charging ports**

- ▶ Center console

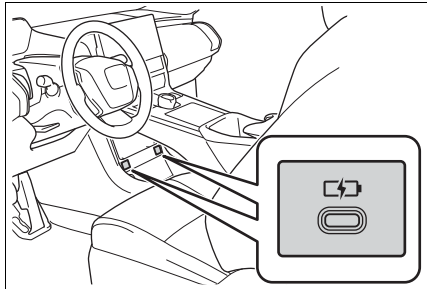

- ▶ Rear

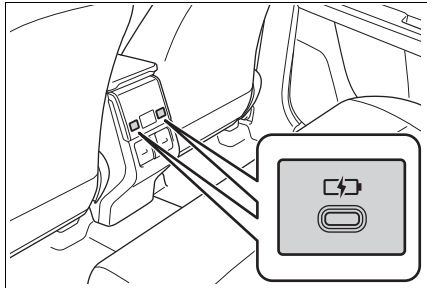

■ **The USB Type-C charging ports can be used when**

The power switch is in ACC or ON.

■ **Situations in which the USB Type-C charging ports may not operate correctly**

- If a device which consumes more than 3 A at 5 V is connected
- If a device designed to communicate with a personal computer,

such as a USB memory device, is connected

- If the connected external device is turned off (depending on device)
- If the temperature inside the vehicle is high, such as after the vehicle has been parked in the sun

■ **About connected external devices**

Depending on the connected external device, charging may occasionally be suspended and then start again. This is not a malfunction.

| | |
|--|----------------------|
|  | <p>NOTICE</p> |
| <p>■ To prevent damage to the USB Type-C charging ports</p> <ul style="list-style-type: none"> ● Do not insert foreign objects into the ports. ● Do not spill water or other liquids into the ports. ● Do not apply excessive force to or impact the USB Type-C charging ports. ● Do not disassemble or modify the USB Type-C charging ports. <p>■ To prevent damage to external devices</p> <ul style="list-style-type: none"> ● Do not leave external devices in the vehicle. The temperature inside the vehicle may become high, resulting in damage to an external device. ● Do not push down on or apply unnecessary force to an external device or the cable of an external device while it is connected. <p>■ To prevent 12-volt battery discharge</p> <p>Do not use the USB Type-C charging ports for a long period of time with the EV system stopped.</p> | |

Wireless charger (if equipped)

A portable device can be charged by just placing Qi standard wireless charge compatible portable devices according to the Wireless Power Consortium, such as smartphones and mobile batteries, etc., on the charge area.

This function cannot be used with portable devices that are larger than the charging tray. Also, depending on the portable device, it may not operate as normal. Please read the operation manual for portable devices to be used.

■ **The “Qi” symbol**

The “Qi” symbol is a trademark of the Wireless Power Consortium.



■ Name for all parts

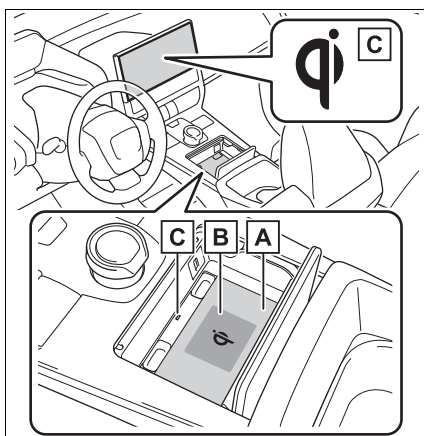

A Charging tray

B Charging area*

C Operation indicator light

*: Portable devices and wireless chargers contain charging coils. The charging coil in the wireless charger can be moved within the charge area near the center of the charging tray. If the charging coil inside a portable device is detected in the charge area, the charging coil inside the wireless charger will move toward it and start charging. If the charging coil inside a portable device moves outside of the charge area, charging will automatically stop. If 2 or more portable devices are placed on the charging tray, their charging coils may not be properly detected and they may not be charged.

■ Using the wireless charger

- 1 Open the lid.
- 2 Place the portable device on the charging tray.

Place the charging side of the portable device down with the center of the device in the center of the charge area.

Depending on the portable device, the charging coil may not be located in the center of the device. In this case, place the portable device so that its charging coil is in the center of the charge area.

While charging, the operation indicator light (orange) comes on.

If charging is not occurring, try placing the portable device as close to the center of the charging area as possible.

When charging is complete, the operation indicator light (green) comes on.

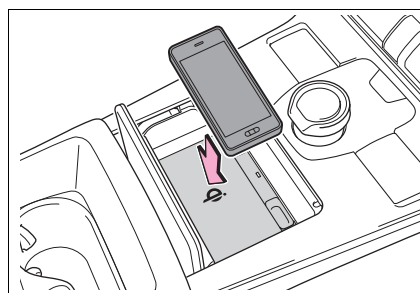

■ Recharging function

- When charging is complete and after a fixed time in the charge suspension state, charging restarts.
- When a portable device is moved significantly in the charge area, the charging coil is disconnected and charging is stopped momentarily. However, if there is a charging coil in the charge area, the charging coil inside the wireless charger will move toward it and then charging restarts.

■ **Rapid charging function**

- The following portable devices support rapid charging.
- Portable devices compliant with WPC Ver1.2.4 and compatible with rapid charging

- iPhone's with an iOS version that supports 7.5 W charging (iPhone 8 and later models)
- When a portable device that supports rapid charging is charged, charging automatically switches to the rapid charging function.

■ **Lighting conditions of operation indicator light**

| Operation indicator light | | Conditions |
|---------------------------|-------------------------------|---|
| Charging tray side | Multimedia system screen side | |
| Turning off | Disappear | When the Wireless charger power supply is off |
| Green (comes on) | Gray | On Standby (charging possible state) ^{*1} |
| | | When charging is complete ^{*2} |
| Orange (comes on) | Blue | When placing the portable device on the charging area (detecting the portable device) |
| | | Charging |

^{*1}: Charging power will not be output during standby. A metallic object will not be heated, if it is placed on the charging tray in this state.

^{*2}: Depending on the portable device, there are cases where the operation indicator light will continue being lit up orange even after the charging is complete.

■ **The wireless charger is not working properly.**

The following are situations in which the wireless charger does not work properly and how to deal with the possible causes.

| Operation indicator light | Multimedia system screen | Suspected causes/Handling method |
|--|--------------------------|---|
| Orange (Flashing repeatedly once every second) | Gray | <p>Wireless charger and smart key communication failure → If the EV system is turned on, off and then restart the EV system</p> <p>If the power switch is in ACC, start the EV system. (→P.231)</p> |
| Green (Flashing repeatedly once every second) | Disappear | <p>Wireless charger and multimedia system communication failure → If the EV system is turned on, off and then restart the EV system</p> <p>If the power switch is in ACC, start the EV system. (→P.231)</p> |
| Green (comes on) | Blue | <p>AM radio stations are being automatically selected → Wait until the system has completed the automatic selection of AM radio stations. In the case that automatic selection cannot be completed, stop automatic selection.</p> |
| | | <p>The smart key system is detecting the key → Please wait until the key detection is complete.</p> |

| Operation indicator light | Multimedia system screen | Suspected causes/Handling method |
|--|--------------------------|--|
| Orange (Repeatedly flashes 3 times continuously) | Gray | Foreign substance detection: A metallic foreign substance is in the charge area, and so the abnormal heating prevention function of the charging coil operated → Remove the foreign substance from the charge area. |
| | | Portable device misaligned: → The charging coil in the portable device moved outside of the charge area, and so the abnormal heating prevention function of the charging coil operated |
| Orange (Repeatedly flashes 4 times continuously) | Gray | Safety shutdown resulting when the temperature within the wireless charger exceeded the set value → Stop charging, remove the portable device from the charging tray, wait for the temperature to drop, and then start charging again. |

■ **The wireless charger can be operated when**

The power switch is in ACC or ON.

■ **Portable devices that can be charged**

- Portable devices compatible with the Qi wireless charging standard can be charged by the wireless charger. However, compatibility with all devices which meet the Qi wireless charging standard is not guaranteed.
- The wireless charger is designed to supply low power electricity (5 W or less) to a cellular phone, smartphone, or other portable device.
- Failure to do so may result in the possibility of fire. However, port-

able devices, such as the following, can be charged with more than 5 W.

- 7.5 W charging compatible iPhones can be charged at 7.5 W or less.
- Portable devices which conform to WPC Ver 1.2.4 (Extended Power profile) can be charged at 10 W or less.

■ **When covers and accessories are attached to portable devices**

Do not charge in situations where cover and accessories not able to handle Qi are attached to the portable device. Depending on the type of cover (including for certain genuine manufacturer parts) and accessory, it may not be possible to charge.

When charging is not performed

even with the portable device placed on the charge area, remove the cover and accessories.

■ Charging precautions

- If the electronic key cannot be detected in the cabin, charging cannot be performed. When a door is opened and closed, charging may be temporarily suspended.
- While charging, the wireless charger and the portable device will become warm. This is not a malfunction.
If a portable device becomes warm while charging and charging stops due to the protection function of the portable device, wait until the portable device cools down and charge it again.
- Depending on usage of the portable device, it may not be fully charged. This is not a malfunction.

■ Important points of the wireless charger

- If the electronic key cannot be detected within the vehicle interior, charging can not be done. When the door is opened and closed, charging may be temporarily suspended.
- When charging, the wireless charging device and portable device will get warmer, however this is not a malfunction. When a portable device gets warm while charging may stop due to the protection function on the portable device side. In this case, when the temperature of the portable drops significantly, charge again. The fan may start operating to lower the temperature inside the wireless charger, however this is not a malfunction.

■ Sound generated during operation

When the power supply switch is turned on or while a portable device is being identified, operation sounds

may be heard. This is not a malfunction.

■ Cleaning the wireless charger

→P.452

■ Certification

→P.623

WARNING

■ Caution while driving

When charging a portable device, for safety reasons, the driver should not operate the main part of the portable device while driving.

■ Caution while in motion

Do not charge lightweight devices such as wireless headphones while in motion. These devices are very light and may be ejected from the charging tray, which may lead to unforeseen accidents.

■ Caution regarding interference with electronic devices

People with implantable cardiac pacemakers, cardiac resynchronization therapy-pacemakers or implantable cardioverters, as well as any other electrical medical device, should consult their physician about the usage of the wireless charger.

■ To prevent malfunctions or burns

Observe the following precautions. Failure to do so may result in a equipment failure and damage, catch fire, burns due to overheat or electric shock.

- Do not insert any metallic objects between the charge area and the portable device while charging
- Do not attach an aluminum sticker or other metallic object to the charge area



WARNING

- Do not attach an aluminum sticker or other metallic object to the side of the portable device (or to its case or cover) that touches the charge area
- Do not use the charging tray as a small storage space
- Do not subject to a strong force or impact
- Do not disassemble, modify or remove
- Do not charge devices other than specified portable devices
- Keep away from magnetic items
- Do not charge devices if the charge area is covered in dust
- Do not cover with a cloth or similar material



NOTICE

■ **Situations in which the function may not operate normally**

Devices may not be charged normally in the following situations.

- The portable device is fully charged
- The portable device is being charged with a cable connected
- There is foreign matter between the charge area and portable device
- Charging has caused the portable device to heat up
- The temperature around the charging tray is 95°F (35°C) or higher, such as in extreme heat
- The portable device is placed with its charging side facing up

- The portable device is placed in an area misaligned from the charge area
- The portable device is larger than the charging tray
- A foldable and portable device is placed outside the charge area
- The camera lens protrudes 0.12 in. (3 mm) or more from the surface of the portable device
- The vehicle is in an area where strong electrical waves or noise are emitted, such as near a television tower, power plant, gasoline station, broadcasting station, large display, airport, etc.
- Any of the following objects that is protrudes 0.12 in. (3 mm) or thicker is stuck or installed between the charging side of the portable device and the charge area.
 - Thick cases or covers
 - A case or cover attached with an uneven or tilted surface, so that the charging side is not flat
 - Thick decorations
 - Accessories, such as finger rings, straps, etc.
- When the portable device is in contact with, or is covered by any of the following metallic objects:
 - A card that has metal on it, such as aluminum foil, etc.
 - A pack of cigarettes that includes aluminum foil
 - A wallet or bag that is made of metal
 - Coins

⚠ NOTICE

- A heating pad
- CDs, DVDs or other media
- A metal accessory
- A case or cover made of metal
- Electric wave type wireless remote controls are being used nearby
- The electronic key is not inside the vehicle
- 2 or more portable devices are placed on the charging tray at the same time

If charging is abnormal or the operation indicator light continues to flash for any other reason, the wireless charger may be malfunctioning. Contact your Toyota dealer.

■ To prevent malfunctions and data corruptions

- When charging, bringing a credit, or other magnetic card, or magnetic storage media close to the charge area may clear any stored data due to magnetic influence. Also, do not bring a wristwatch or other precision instrument close to the charge area since doing so may cause it to malfunction.
- Do not charge with a non-contact IC card such as a transportation system IC card inserted between the charging side of a portable device and the charge area. The IC chip may become extremely hot and damage the portable device or IC card. Be especially careful not to charge a portable device inside a case or cover with a non-contact IC card attached.

- Do not leave portable devices inside the vehicle. The inside of the vehicle can become hot in extreme heat, which could cause a malfunction.

■ If the smartphone OS has been updated

If the smartphone OS has been updated to a newer version, its charging specifications may have changed significantly. For details, check the information on the manufacturer's website.

■ To prevent 12-volt battery discharge

Do not use the wireless charger for a long period of time when the EV system is stopped.

Armrest

Fold down the armrest for use.

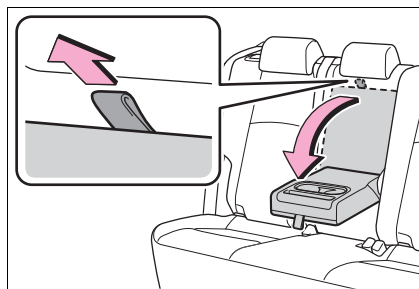
**⚠ NOTICE****■ To prevent damage to the armrest**

Do not apply too much load on the armrest.

Coat hooks

The coat hooks are provided with the rear assist grips.

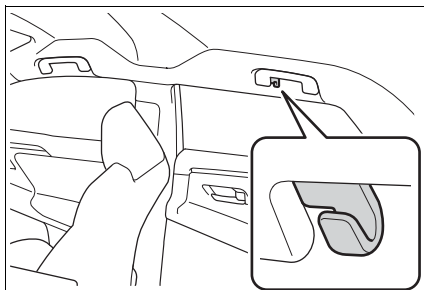

 NOTICE

■ **To prevent damage to the assist grip**

Do not hang any heavy object or put a heavy load on the assist grip.

 **WARNING**

■ **Items that must not be hanged on the hook**

Do not hang coat hangers or other hard or sharp objects on the hook. If the SRS curtain shield airbags deploy, these items may become projectiles, causing death or serious injury.

Assist grips

An assist grip installed on the ceiling can be used to support your body while sitting on the seat.

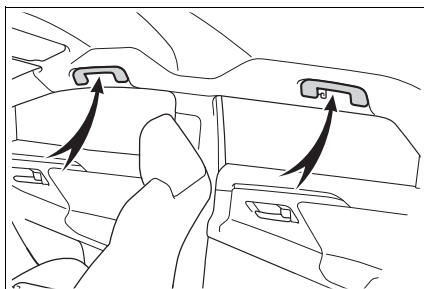

 **WARNING**

■ **Assist grips**

Do not use the assist grip when getting in or out of the vehicle or rising from your seat.

Garage door opener*

*: If equipped

The garage door opener can be programmed using the HomeLink® to operate garage doors, gates, entry doors, door locks, home lighting systems, security systems, and other devices.

HomeLink® programming procedure

The programming procedures can also be found at the following URL.

Website: www.homelink.com/toyota



For support, contact customer support at the following.

Help Line: 1-800-355-3515

System components

The HomeLink® wireless control system in your vehicle has 3 buttons which can be programmed to operate 3 different devices. Refer to the programming methods on the following pages to determine the method which is appropriate for the device.

▶ Vehicles with auto anti-glare inside rear view mirror

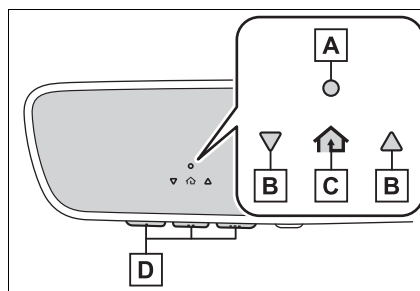

A HomeLink® indicator light

B Garage door operation indicators

C HomeLink® icon

Illuminates while HomeLink® is operating.

D Buttons

▶ Vehicles with Digital Rear-view Mirror

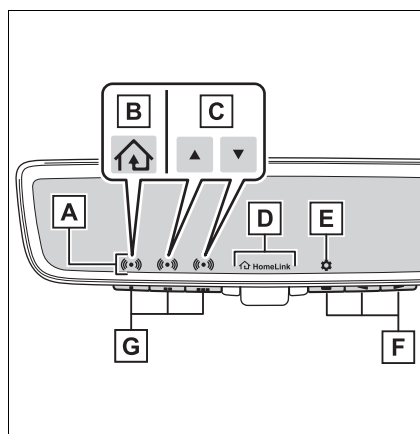

A HomeLink® indicator light

Illuminates above each button selected.

B HomeLink® icon

C Garage door operation indicators

D HomeLink® logo

Appears while HomeLink® is operating.

When the HomeLink® button is pressed, the logo disappears even while the HomeLink® is operating.

E Setting icon

Press the menu button to change the setting.

F Menu buttons

G HomeLink® buttons

■ **Codes stored in the HomeLink® memory**

- The registered codes are not erased even if the 12-volt battery cable is disconnected.
- If learning failed when registering a different code to a HomeLink® button that already has a code registered to it, the already registered code will not be erased.

■ **Certification**

→P.624

⚠ WARNING

■ **When programming a garage door or other remote control device**

The garage door or other device may operate, so ensure people and objects are out of danger to prevent potential harm.

■ **Conforming to federal safety standards**

Do not use the HomeLink® compatible transceiver with any garage door opener or device that lacks safety stop and reverse features as required by federal safety standards.

This includes any garage door that cannot detect an interfering object. A door or device without these features increases the risk of death or serious injury.

■ **When operating or programming HomeLink®**

Never allow a child to operate or play with the HomeLink® buttons.

Programming HomeLink®

■ **Before programming HomeLink®**

- During programming, it is possible that garage doors, gates, or other devices may operate. For this reason, make sure that people and objects are clear of the garage door or other devices to prevent injury or other potential harm.
- It is recommended that a new battery be placed in the remote control transmitter for successful programming.
- Garage door opener motors manufactured after 1995 may be equipped with rolling code protection. If this is the case, you may need a stepladder or other sturdy, safe device to

reach the “Learn” or “Smart” button on the garage door opener motor.

■ **Programming HomeLink®**

Steps 2 through 4 must be performed within 60 seconds, otherwise the HomeLink® indicator light will stop flashing and programming will not be successfully completed.

- 1 Vehicles with Digital Rear-view Mirror: Press the HomeLink® button or menu button

When the HomeLink® button is pressed: Homelink® Training Tutorial will be displayed to assist you programming the HomeLink®.

When Homelink® Training Tutorial is displayed, follow the instructions displayed.

When the menu button is pressed: Press the menu button  and select the “Set Up >”. Homelink® Training Tutorial will be displayed to assist you programming the HomeLink®.

When Homelink® Training Tutorial is displayed, follow the instructions displayed.

- 2 Press and release the HomeLink® button you want to program and check that the HomeLink® indicator light flashes (orange).
- 3 Point the remote control transmitter for the device at the rear view mirror, 1 to 3 in.

(25 to 75 mm) from the HomeLink® buttons.

Keep the HomeLink® indicator light in view while programming.

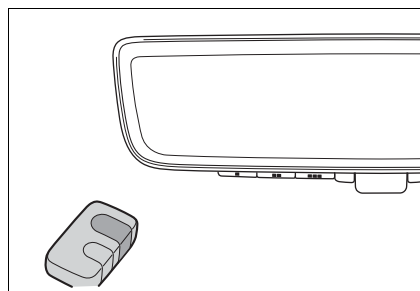

- 4 Program a device.

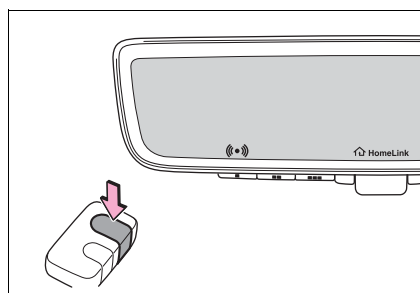

- ▶ Programming a device other than an entry gate (for U.S.A. owners)

Press and hold the remote control transmitter button until the HomeLink® indicator light changes from slowly flashing orange to rapidly flashing green (rolling code) or continuously lit green (fixed code), then release the button.

- ▶ Programming an entry gate (for U.S.A. owners)/Programming a device in the Canadian market

Press and release the remote

control transmitter button at 2 second intervals, repeatedly, until the HomeLink[®] indicator light changes from slowly flashing orange to rapidly flashing (green) (rolling code) or continuously lit (green) (fixed code).

- 5 Test the HomeLink[®] operation by pressing the newly programmed button and observing the HomeLink[®] indicator light:
 - HomeLink[®] indicator light illuminates: Programming of a fixed code device has completed. The garage door or other device should operate when a HomeLink[®] button is pressed and released.
 - HomeLink[®] indicator light flashes rapidly: The garage door opener or other device is equipped with a rolling code. To complete programming, firmly press and hold the HomeLink[®] button for 2 seconds then release it.
 - If the garage door or other device does not operate, proceed to “Programming a rolling code system”.
- 6 Repeat the steps above to program another device for any of the remaining HomeLink[®] buttons.

■ Programming a rolling code system

Two or more people may be needed to complete rolling code programming.

- 1 Locate the “Learn” or “Smart” button on the garage door opener motor in the garage.

This button can usually be found where the hanging antenna wire is attached to the unit. The name and color of the button may vary by manufacturer. Refer to the owner’s manual supplied with the garage door opener motor for details.

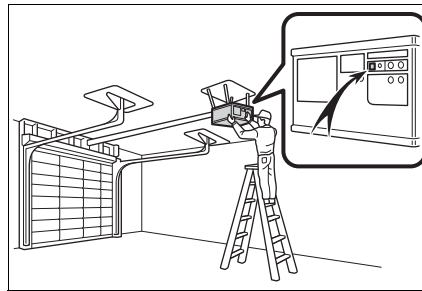

- 2 Press and release the “Learn” or “Smart” button.

Perform 3 within 30 seconds after performing 2.

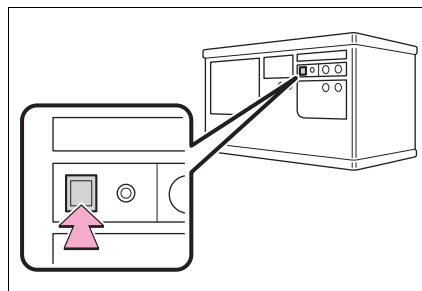

- 3 Press and hold the desired HomeLink[®] button (inside the vehicle) for 2 seconds and release it. Repeat this

sequence (press/hold/release) up to 3 times to complete programming.

If the garage door opener motor operates when the HomeLink® button is pressed, the garage door opener motor recognizes the HomeLink® signal.

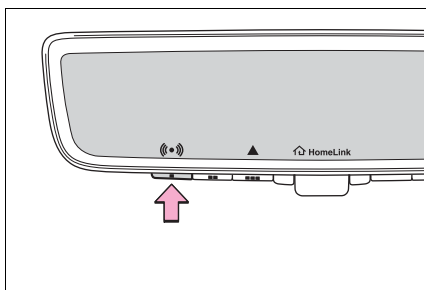

■ **Enabling 2-way communication with a garage door (only available for compatible devices)**

When enabled, 2-way communication allows you to check the status of the opening and closing of a garage door through indicators in your vehicle.

2-way communication is only available if the garage door opener motor used is a compatible device. (To check device compatibility, refer to www.homelink.com.)

- 1 Within 5 seconds after programming the garage door opener has been completed, if the garage door opener motor is trained to Home-

Link®, both garage door operation indicators will flash rapidly (green) and the light on the garage door opener motor will blink twice, indicating that 2-way communication is enabled.

If the indicators do not flash, perform 2 and 3 within the first 10 presses of the HomeLink® button after programming has been completed.

- 2 Press a programmed HomeLink® button to operate a garage door.
- 3 Within 1 minute of pressing the HomeLink® button, after the garage door operation has stopped, press the “Learn” or “Smart” button on the garage door opener motor. Within 5 seconds of the establishment of 2-way communication with the garage door opener, both garage door operation indicators in the vehicle will flash rapidly (green) and the light on the garage door opener motor will blink twice, indicating that 2-way communication is enabled.

■ **Reprogramming a single HomeLink® button**

When the following procedure is performed, buttons which already have devices registered to them can be overwritten:

- 1 Press and hold the desired HomeLink[®] button.
- 2 When the HomeLink[®] indicator starts flashing orange, release the HomeLink[®] button and perform "Programming HomeLink[®]" 1 (it takes 20 seconds for the HomeLink[®] indicator to start flashing).

■ Before programming

- Install a new battery in the transmitter.
- The battery side of the transmitter must be pointed away from the HomeLink[®] buttons.

Operating HomeLink[®]

Press the appropriate HomeLink[®] button. The HomeLink[®] indicator light should turn on. The status of the opening and closing of a garage door is shown by the garage door operation indicators.

- ▶ Vehicles with auto anti-glare inside rear view mirror

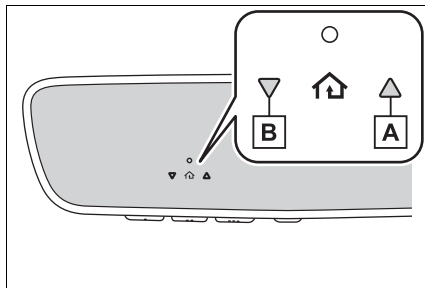

A Opening

B Closing

- ▶ Vehicles with Digital Rear-view Mirror

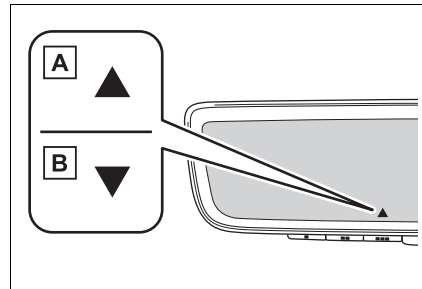









A Opening

B Closing

This function is only available if the garage door opener motor used is a compatible device. (To check device compatibility, refer to www.homelink.com.)

| Color | Status |
|-------------------|-------------------------------------|
| Orange (flashing) | Currently opening/closing |
| Green | Opening/closing has completed |
| Red (flashing) | Feedback signals cannot be received |

The indicators can operate within approximately 820 ft. (250 m) of the garage door. However, if there are obstructions between the garage door and the vehicle, such as houses and trees, feedback signals from the garage door may not be received.

To recall the previous door operation status, press and release either HomeLink® buttons  and  or  and  (vehicles with auto anti-glare inside rear view mirror),  and  or  and  (vehicles with Digital Rear-view Mirror) simultaneously. The last recorded status will be displayed for 3 seconds.

Erasing the entire HomeLink® memory (all three codes)

Press and hold the 2 outside buttons for 10 seconds until the HomeLink® indicator light changes from continuously lit (orange) to rapidly flashing (green).

If you sell your vehicle, be sure to erase the programs stored in the HomeLink® memory.

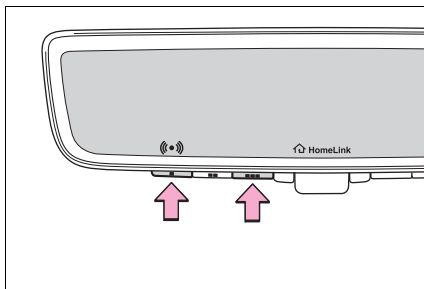

Maintenance and care**7****7-1. Maintenance and care**

Cleaning and protecting the
vehicle exterior 448

Cleaning and protecting the
vehicle interior 451

7-2. Maintenance

Maintenance requirements
..... 455

General maintenance.. 456

Emission inspection and
maintenance (I/M) pro-
grams 459

**7-3. Do-it-yourself main-
tenance**

Do-it-yourself service pre-
cautions..... 460

Hood 462

Positioning a floor jack 464

Motor compartment..... 465

Tires 472

Replacing the tire 485

Tire inflation pressure.. 491

Wheels 493

Air conditioning filter.... 494

Electronic key battery.. 497

Checking and replacing
fuses..... 499

Headlight aim 501

Light bulbs..... 502

Cleaning and protecting the vehicle exterior

Perform the following to protect the vehicle and maintain it in prime condition:

Cleaning instructions

- Working from top to bottom, liberally apply water to the vehicle body, wheel wells and underside of the vehicle to remove any dirt and dust.
- Wash the vehicle body using a sponge or soft cloth, such as a chamois.
- For hard-to-remove marks, use car wash soap and rinse thoroughly with water.
- Wipe away any water.
- Wax the vehicle when the waterproof coating deteriorates.

If water does not bead on a clean surface, apply wax when the vehicle body is cool.

■ Self-restoring coat

The vehicle body has a self-restoring coating that is resistant to small surface scratches caused in a car wash, etc.

- The coating lasts for 5 to 8 years from when the vehicle is delivered from the plant.
- The restoration time differs depending on the depth of the

scratch and outside temperature. The restoration time may become shorter when the coating is warmed by applying warm water.

- Deep scratches caused by keys, coins, etc., cannot be restored.
- Do not use wax that contain abrasives.

■ Automatic car washes

- Before washing the vehicle:
 - Fold the mirrors
 - Turn off the power back door (if equipped)

Start washing from the front of the vehicle. Make sure to extend the mirrors before driving.

- Brushes used in automatic car washes may scratch the vehicle surface, parts (wheel, etc.) and harm your vehicle's paint.
- Rear spoiler may not be washable in some automatic car washes. There may also be an increased risk of damage to vehicle.
- When the shift position needs to be held in N, refer to P.239.

■ High pressure car washes

As water may enter the cabin, do not bring the nozzle tip near the gaps around the doors or perimeter of the windows, or spray these areas continuously.

■ Note for a smart key system

- If the door handle becomes wet while the electronic key is within the effective range, the door may lock and unlock repeatedly. In that case, follow the following correction procedures to wash the vehicle:
 - Place the key in a position 6 ft. (2 m) or more separate from the vehicle while the vehicle is being washed. (Take care to ensure that the key is not stolen.)
 - Set the electronic key to battery-saving mode to disable the smart key system. (→P.188)

- If the electronic key is inside the vehicle and a door handle becomes wet during a car wash, a buzzer may sound outside the vehicle and “Key Detected In Vehicle” may be shown on the multi-information display. To turn off the alarm, lock all the doors.

■ **Wheels and wheel ornaments**

- Remove any dirt immediately by using a neutral detergent.
- Wash detergent off with water immediately after use.
- To protect the paint from damage, make sure to observe the following precautions.
 - Do not use acidic, alkaline or abrasive detergent
 - Do not use hard brushes
 - Do not use detergent on the wheels when they are hot, such as after driving or parking in hot weather

■ **Painted brake calipers (if equipped)**

- When using detergent, use neutral detergent. Do not use hard brushes or abrasive cleaners, as they will damage the paint.
- Do not use detergent on the brake calipers when they are hot.
- Wash detergent off immediately after use.

■ **Brake pads and calipers**

Rust may form if the vehicle is parked with wet brake pads or disc rotors, causing them to stick. Before parking the vehicle after it is washed, drive slowly and apply the brakes several times to dry the parts.

■ **Bumpers**

Do not scrub with abrasive cleaners.

■ **Plated portions**

If dirt cannot be removed, clean the parts as follows:

- Use a soft cloth dampened with an

approximately 5% solution of neutral detergent and water to clean the dirt off.

- Wipe the surface with a dry, soft cloth to remove any remaining moisture.
- To remove oily deposits, use alcohol wet wipes or a similar product.

⚠ WARNING

■ **When washing the vehicle**

Do not apply water to the inside of the motor compartment. Doing so may cause the electrical components, etc. to catch fire.

■ **When cleaning the windshield (vehicles with rain-sensing windshield wipers)**

Set the wiper switch to off. If the wiper switch is in “AUTO”, the wipers may operate unexpectedly in the following situations, and may result in hands being caught or other serious injuries and cause damage to the wiper blades.

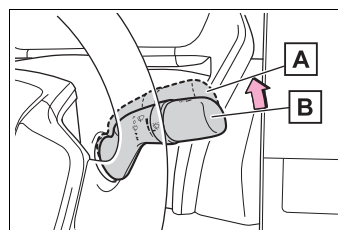

A Off

B “AUTO”

- When the upper part of the windshield where the raindrop sensor is located is touched by hand
- When a wet rag or similar is held close to the raindrop sensor



WARNING

- If something bumps against the windshield
- If you directly touch the raindrop sensor body or if something bumps into the raindrop sensor

■ **Precaution regarding the rear bumper**

If the paint of the rear bumper is chipped or scratched, the system may malfunction. If this occurs, consult your Toyota dealer.

- Toyota Safety Sense 3.0
- BSM (if equipped)
- RCTA (if equipped)
- PKSBS (if equipped)



NOTICE

■ **To prevent paint deterioration and corrosion on the body and components (aluminum wheels, etc.)**

- Wash the vehicle immediately in the following cases:
 - After driving near the sea coast
 - After driving on salted roads
 - If coal tar or tree sap is present on the paint surface
 - If dead insects, insect droppings or bird droppings are present on the paint surface
 - After driving in an area contaminated with soot, oily smoke, mine dust, iron powder or chemical substances
 - If the vehicle becomes heavily soiled with dust or mud
 - If liquids such as benzene and gasoline are spilled on the paint surface

- If the paint is chipped or scratched, have it repaired immediately.
- To prevent the wheels from corroding, remove any dirt and store in a place with low humidity when storing the wheels.

■ **Cleaning the exterior lights**

- Wash carefully. Do not use organic substances or scrub with a hard brush. This may damage the surfaces of the lights.
- Do not apply wax to the surfaces of the lights. Wax may cause damage to the lenses.

■ **When using an automatic car wash (vehicles with rain-sensing windshield wipers)**

Set the wiper switch to off position. If the wiper switch is in "AUTO", the wipers may operate and the wiper blades may be damaged.

■ **When using a high pressure car wash**

- When washing the vehicle, do not spray the camera or its surrounding area directly with a high pressure washer. Shock applied from high pressure water may cause the device to not operate normally.
- Do not spray water directly on the radar which is equipped behind the radar sensor cover. Otherwise it may cause the device to be damaged.
- Do not bring the nozzle tip close to boots (rubber or resin manufactured cover), or connectors or the following parts. The parts may be damaged if they come into contact with high-pressure water.

 NOTICE

- Traction related parts
- Steering parts
- Suspension parts
- Brake parts
- Keep the cleaning nozzle at least 11.9 in. (30 cm) away from the vehicle body. Otherwise resin section, such as moldings and bumpers, may be deformed and damaged. Also, do not continuously hold the nozzle in the same place.
- Do not spray the lower part of the windshield continuously. If water enters the air conditioning system intake located near the lower part of the windshield, the air conditioning system may not operate correctly.
- Do not wash the underside of the vehicle using a high pressure car washer. If water enters the traction battery, the EV system may malfunction.
- Do not use the washer on the area around the charging port lid. Water could get into the charging inlet and could damage the vehicle.

■ **Cleaning aluminum parts**

When cleaning the hood, do not push hard or put weight on it. The aluminum part may be dented.

Cleaning and protecting the vehicle interior

Perform cleaning in a manner appropriate to each component and its material.

Protecting the vehicle interior

- Remove dirt and dust using a vacuum cleaner. Wipe dirty surfaces with a cloth dampened with lukewarm water.
- If dirt cannot be removed, wipe it off with a soft cloth dampened with neutral detergent diluted to approximately 1%.
Wring out any excess water from the cloth and thoroughly wipe off remaining traces of detergent and water.

■ **Shampooing the carpets**

There are several commercial foaming-type cleaners available. Use a sponge or brush to apply the foam. Rub in overlapping circles. Do not use water. Wipe dirty surfaces and let them dry. Excellent results are obtained by keeping the carpet as dry as possible.

■ **Handling the seat belts**

Clean with mild soap and lukewarm water using a cloth or sponge. Also check the belts periodically for excessive wear, fraying or cuts.

■ **Front side windows with IR protective coating**

The front side windows have IR protective coating. To prevent any dam-

age to the IR protective coating, observe the following:

- If the windows are dirty, gently wipe them with a cloth soaked in water or lukewarm water as soon as possible.
- If the windows are very dirty, do not open and close them repeatedly.

 **WARNING**

■ **Water in the vehicle**

- Do not splash or spill liquid in the vehicle. Doing so may cause the electrical components, etc., to malfunction or catch fire.
- Do not get any of the SRS components or wiring in the vehicle interior wet. (→P.35)
An electrical malfunction may cause the airbags to deploy or not function properly, resulting in death or serious injury.
- Vehicles with wireless charger: Do not let the wireless charger (→P.430) get wet. Failure to do so may cause the charger to become hot and cause burns or could cause electric shock resulting in death or serious injury.

■ **Cleaning the interior (especially instrument panel)**

Do not use a polish wax or polish cleaner. The instrument panel may reflect off the windshield, obstructing the driver's view and leading to an accident, resulting in death or serious injury.

 **NOTICE**

■ **Cleaning detergents**

- Do not use the following types of detergent, as they may discolor the vehicle interior or cause streaks or damage to painted surfaces:
 - Non-seat portions: Organic substances such as benzene or gasoline, alkaline or acidic solutions, dye, and bleach
 - Seats: Alkaline or acidic solutions, such as thinner, benzene, and alcohol
- Do not use a polish wax or polish cleaner. The instrument panel's or other interior part's painted surface may be damaged.

■ **Water on the floor**

Do not wash the vehicle floor with water. Vehicle systems such as the audio system may be damaged if water comes into contact with electrical components such as the audio system above or under the floor of the vehicle. Water may also cause the body to rust.

■ **When cleaning the inside of the windshield**

Do not allow glass cleaner to contact the lens. Also, do not touch the lens. (→P.259)

■ **Cleaning the inside of the rear window**

- Do not use a glass cleaner to clean the rear window, as this may cause damage to the rear window defogger heater wires. Use a cloth dampened with lukewarm water to gently wipe the window clean. Wipe the window in strokes running parallel to the heater wires.

**NOTICE**

- Be careful not to scratch or damage the heater wires.

■ **Cleaning the front side windows**

Do not use any compound or abrasive product (e.g., glass cleaner, detergent, wax) to clean the windows. It may damage the coating.

Cleaning the areas with satin-finish metal accents

- Remove dirt using a water dampened soft cloth or synthetic chamois.
- Wipe the surface with a dry soft cloth to remove any remaining moisture.

■ **Cleaning the areas with satin-finish metal accents**

The metal areas use a layer of real metal for the surface. It is necessary to clean them regularly. If dirty areas are left uncleaned for long periods of time, they may be difficult to clean.

Cleaning the leather areas

- Remove dirt and dust using a vacuum cleaner.
- Wipe off any excess dirt and dust with a soft cloth dampened with diluted detergent.

Use a diluted water solution of approximately 5% neutral wool detergent.

- Wring out any excess water from the cloth and thoroughly

wipe off all remaining traces of detergent.

- Wipe the surface with a dry, soft cloth to remove any remaining moisture. Allow the leather to dry in a shaded and ventilated area.

■ **Caring for leather areas**

Toyota recommends cleaning the interior of the vehicle at least twice a year to maintain the quality of the vehicle's interior.

**NOTICE**

■ **Preventing damage to leather surfaces**

Observe the following precautions to avoid damage to and deterioration of leather surfaces:

- Remove any dust or dirt from leather surfaces immediately.
- Do not expose the vehicle to direct sunlight for extended periods of time. Park the vehicle in the shade, especially during summer.
- Do not place items made of vinyl, plastic, or containing wax on the upholstery, as they may stick to the leather surface if the vehicle interior heats up significantly.

Cleaning the synthetic leather areas

- Remove dirt and dust using a vacuum cleaner.
- Wipe it off with a soft cloth dampened with neutral detergent diluted to approximately 1%.

- Wring out any excess water from the cloth and thoroughly wipe off remaining traces of detergent and water.

Cleaning fabric portions

- To remove dust from the fabric, use a vacuum cleaner or adhesive tape.

However, please remove the dust near the passenger airbag ornament by hand.

- Use a cloth dampened with water to gently wipe the fabric clean.

Do not use detergents to clean the fabric.

- Vehicles with radiant heaters:
Do not hard scrub on the fabric portion of the radiant heaters (→P.413).

Maintenance requirements

To ensure safe and economical driving, day-to-day care and regular maintenance are essential. It is the owner's responsibility to perform regular checks. Toyota recommends the following maintenance:

■ Repair and replacement

It is recommended that genuine Toyota parts be used for repairs to ensure performance of each system. If non-Toyota parts are used in replacement or if a repair shop other than a Toyota dealer performs repairs, confirm the warranty coverage.

■ Allow inspection and repairs to be performed by a Toyota dealer

- Toyota technicians are well-trained specialists and are kept up to date with the latest service information. They are well informed about the operations of all systems on your vehicle.
- Keep a copy of the repair order. It proves that the maintenance that has been performed is under warranty coverage. If any problem should arise while your vehicle is under warranty, your Toyota dealer will promptly take care of it.

⚠ WARNING

■ If your vehicle is not properly maintained

Improper maintenance could result in serious damage to the vehicle and possible death or serious injury.

■ Handling of the 12-volt battery

- Oils and fluids contained in vehicles as well as waste produced by component wear contain or emit chemicals known to the State of California to cause cancer and birth defects or other reproductive harm. Avoid exposure and wash any affected area immediately.
- 12-volt battery posts, terminals and related accessories contain lead and lead compounds which are known to cause brain damage. Wash your hands after handling. (→P.468)

General maintenance

General maintenance should be performed on a daily basis. This can be done by yourself or by a Toyota dealer.

Scheduled maintenance

Scheduled maintenance should be performed at specified intervals according to the maintenance schedule.

For details about maintenance items and schedules, refer to the "Scheduled Maintenance Guide" or "Owner's Manual Supplement".

Do-it-yourself maintenance

You can perform some maintenance procedures by yourself. Please be aware that do-it-yourself maintenance may affect

warranty coverage.

The use of Toyota Repair Manuals is recommended.

For details about warranty coverage, refer to the separate “Owner’s Warranty Information Booklet” or “Owner’s Manual Supplement”.

General maintenance

Listed below are the general maintenance items that should be performed at the intervals specified in the “Owner’s Warranty Information Booklet” or “Owner’s Manual Supplement/Scheduled Maintenance Guide”. It is recommended that any problem you notice should be brought to the attention of your Toyota dealer or qualified service shop for advice.

WARNING

■ If the EV system is running

Turn the EV system off and ensure that there is adequate ventilation before performing maintenance checks.

Motor compartment

| Items | Check points |
|-----------------------------------|--|
| Brake fluid | Is the brake fluid at the correct level? (→P.468) |
| Power control unit/heater coolant | Is the power control unit/heater coolant at the correct level? (→P.465, 467) |
| 12-volt battery | Check the connections. (→P.468) |

| Items | Check points |
|--------------------|--|
| Radiator/condenser | The radiator and condenser should be free from foreign objects. (→P.466) |
| Washer fluid | Is there sufficient washer fluid? (→P.471) |

Vehicle interior

| Items | Check points |
|-------------------------------|--|
| Accelerator pedal | <ul style="list-style-type: none"> The accelerator pedal should move smoothly (without uneven pedal effort or catching). |
| Transmission "Park" mechanism | <ul style="list-style-type: none"> When parked on a slope and the shift position is in P, is the vehicle securely stopped? |
| Brake pedal | <ul style="list-style-type: none"> Does the brake pedal move smoothly? Does the brake pedal have appropriate clearance from the floor? Does the brake pedal have the correct amount of free play? |

| Items | Check points |
|--------------------|--|
| Brakes | <ul style="list-style-type: none"> The vehicle should not pull to one side when the brakes are applied. The brakes should work effectively. The brake pedal should not feel spongy. The brake pedal should not get too close to the floor when the brakes are applied. |
| Head restraints | <ul style="list-style-type: none"> Do the head restraints move smoothly and lock securely? |
| Indicators/buzzers | <ul style="list-style-type: none"> Do the indicators and buzzers function properly? |
| Lights | <ul style="list-style-type: none"> Do all the lights come on? Are the headlights aimed correctly? |
| Parking brake | <ul style="list-style-type: none"> Does the parking brake operate normally? When parked on a slope and the parking brake is on, is the vehicle securely stopped? |

| Items | Check points |
|----------------|---|
| Seat belts | <ul style="list-style-type: none"> • Do the seat belts operate smoothly? • The seat belts should not be damaged. |
| Seats | <ul style="list-style-type: none"> • Do the seat controls operate properly? |
| Steering wheel | <ul style="list-style-type: none"> • Does the steering wheel rotate smoothly? • Does the steering wheel have the correct amount of free play? • There should not be any strange sounds coming from the steering wheel. |

Vehicle exterior

| Items | Check points |
|-------------|---|
| Doors | <ul style="list-style-type: none"> • Do the doors operate smoothly? |
| Hood | <ul style="list-style-type: none"> • Does the hood lock system work properly? |
| Fluid leaks | <ul style="list-style-type: none"> • There should not be any signs of fluid leakage after the vehicle has been parked. |

| Items | Check points |
|-------------------|--|
| Tires | <ul style="list-style-type: none"> • Is the tire inflation pressure correct? • The tires should not be damaged or excessively worn. • Have the tires been rotated according to the maintenance schedule? • The wheel bolt should not be loose. |
| Windshield wipers | <ul style="list-style-type: none"> • The wiper blades should not show any signs of cracking, splitting, wear, contamination or deformation. • The wiper blades should clear the windshield without streaking or skipping. |

Emission inspection and maintenance (I/M) programs

Some states have vehicle emission inspection programs which include OBD (On Board Diagnostics) checks. The OBD system monitors the operation of the emission control system.

If the malfunction indicator lamp comes on

The OBD system determines that a problem exists somewhere in the emission control system. Your vehicle may not pass the I/M test and may need to be repaired. Contact your Toyota dealer to service the vehicle.

Your vehicle may not pass the I/M test in the following situations:

When the 12-volt battery is disconnected or discharged Readiness codes that are set during ordinary driving are erased.

Also, depending on your driving habits, the readiness codes may not be completely set.

When the malfunction indicator lamp still remains on after several driving trips

The error code in the OBD system will not be cleared unless the vehicle is driven 40 or more times.

If your vehicle does not pass the I/M test

Contact your Toyota dealer to prepare the vehicle for re-testing.

Do-it-yourself service precautions

If you perform maintenance by yourself, be sure to follow the correct procedure as given in these sections.

Maintenance

| Items | Parts and tools |
|------------------------------------|---|
| 12-volt battery condition (→P.468) | <ul style="list-style-type: none"> • Warm water • Baking soda • Grease • Conventional wrench (for terminal clamp bolts) |
| Brake fluid level (→P.468) | <ul style="list-style-type: none"> • FMVSS No.116 DOT 3 or SAE J1703 brake fluid • FMVSS No.116 DOT 4 or SAE J1704 brake fluid • Rag or paper towel • Funnel (used only for adding brake fluid) |

| Items | Parts and tools |
|---|---|
| Power control unit coolant level (→P.467) | <ul style="list-style-type: none"> • In order to ensure maximum performance of the traction battery cooling system and limit risks of battery short-circuit and other damage to your vehicle, Toyota recommends using “Toyota Genuine Traction Battery Coolant” or similar high-quality ethylene glycol-based, low electric conductivity coolant, non-amine and non-borate coolant withazole additives. • Funnel (used only for adding coolant) |

| Items | Parts and tools |
|----------------------------------|---|
| Heater coolant level (→P.465) | <ul style="list-style-type: none"> • “Toyota Super Long Life Coolant” or a similar high quality ethylene glycol-based non-silicate, non-amine, non-nitrite and non-borate coolant with long-life hybrid organic acid technology “Toyota Super Long Life Coolant” is pre-mixed with 50% coolant and 50% deionized water. • Funnel (used only for adding coolant) |
| Fuses (→P.499) | <ul style="list-style-type: none"> • Fuse with same amperage rating as original |
| Headlight aim (→P.501) | <ul style="list-style-type: none"> • Phillips-head screwdriver |
| Radiator and condenser (→P.466) | — |
| Tire inflation pressure (→P.491) | <ul style="list-style-type: none"> • Tire pressure gauge • Compressed air source |
| Washer fluid (→P.471) | <ul style="list-style-type: none"> • Water or washer fluid containing antifreeze (for winter use) • Funnel (used only for adding water or washer fluid) |

⚠ WARNING

The motor compartment contains many mechanisms and fluids that may move suddenly, become hot, or become electrically energized. To avoid death or serious injury, observe the following precautions.

■ When working on the motor compartment

- Make sure that “POWER ON” on the multi-information display and the “READY” indicator are both off.
- Keep hands, clothing and tools away from the moving fan.
- Be careful not to touch the motor, power control unit, radiator, etc., right after driving as they may be hot. Coolant and other fluids may also be hot.
- Do not leave anything that may burn easily, such as paper and rags, in the motor compartment.
- Do not smoke, cause sparks or expose an open flame to the 12-volt battery. 12-volt battery fumes are flammable.
- Be extremely cautious when working on the 12-volt battery. It contains poisonous and corrosive sulfuric acid.
- Never touch, disassemble, remove or replace the high voltage parts, cables and their connectors. It can cause severe burns or electric shock that may result in death or serious injury.

⚠ WARNING

■ **When working near the electric cooling fan or radiator grille**

Be sure the power switch is OFF. With the power switch in ON, the electric cooling fan may automatically start to run if the air conditioning is on and/or the coolant temperature is high. (→P.466)

■ **Safety glasses**

Wear safety glasses to prevent flying or falling material, fluid spray, etc., from getting in your eyes.

Hood

Opening the hood

- 1 Pull the hood lock release lever.

The hood will pop up slightly.

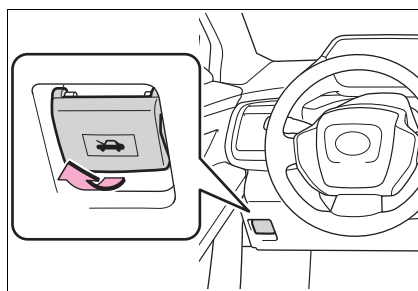

- 2 Push the auxiliary catch lever to the left and lift the hood.

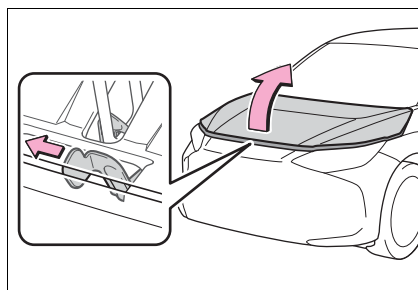

- 3 Hold the hood open by inserting the supporting rod into the slot.

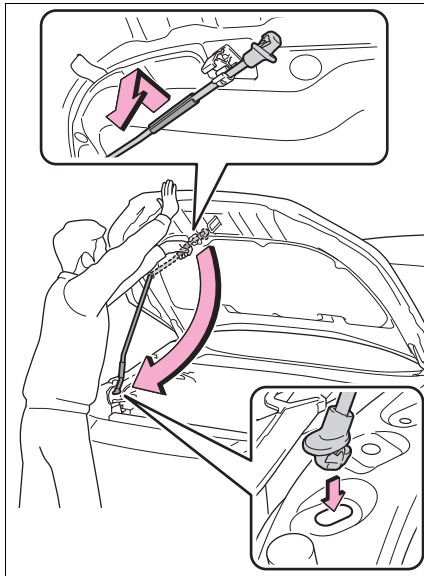

 NOTICE

■ **When closing the hood**

Be sure to return the support rod to its clip before closing the hood. Closing the hood without returning the support rod properly could cause the hood to bend.

 **WARNING**

■ **Pre-driving check**

Check that the hood is fully closed and locked.

If the hood is not locked properly, it may open while the vehicle is in motion and cause an accident, which may result in death or serious injury.

■ **After installing the support rod into the slot**

Make sure the rod is properly inserted into the slot to prevent the hood from shutting on your head or body.

Positioning a floor jack

When using a floor jack, follow the instructions in the manual provided with the jack and perform the operation safely.

When raising your vehicle with a floor jack, position the jack correctly. Improper placement may damage your vehicle or cause injury.

Location of the jack point

■ Front

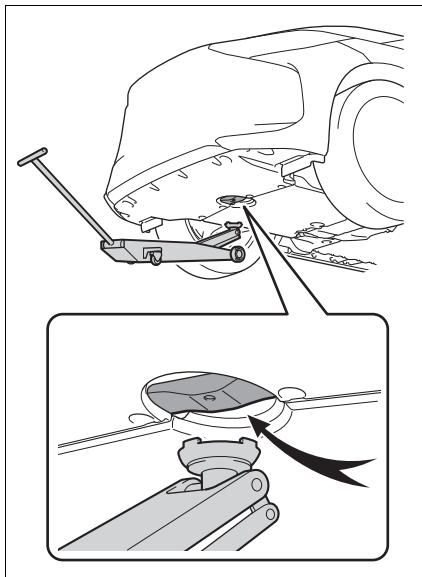

■ Rear

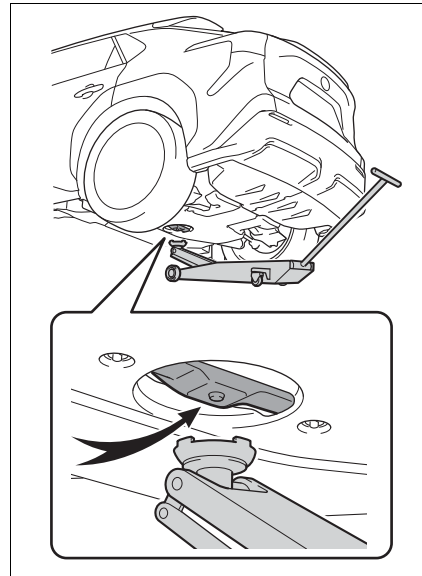

Motor compartment

Components

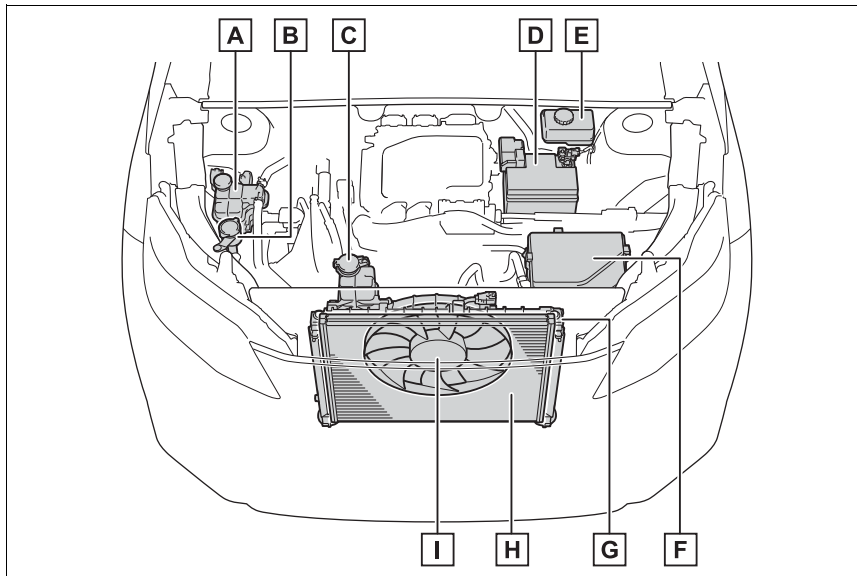

- A** Heater coolant reservoir (→P.465)
- B** Washer fluid tank (→P.471)
- C** Power control unit coolant reservoir (→P.467)
- D** 12-volt battery (→P.468)
- E** Brake fluid reservoir (→P.468)
- F** Fuse box (→P.499)
- G** Radiator (→P.466)
- H** Condenser (→P.466)
- I** Electric cooling fan

Checking the heater coolant

The coolant level is satisfactory if it is between the “MAX” and

“MIN” lines on the reservoir when the EV system is cold.

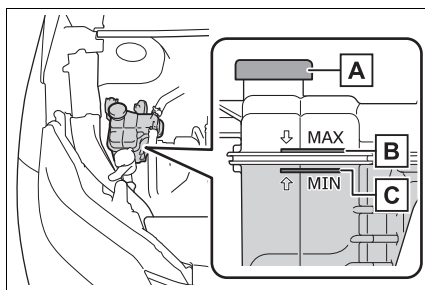

A Reservoir cap

B “MAX” line

C “MIN” line

If the level is on or below the “MIN” line, add coolant up to the “MAX” line. (→P.545)

■ **Coolant selection**

Only use “Toyota Super Long Life Coolant” or a similar high quality ethylene glycol based non-silicate, non-amine, non-nitrite, and nonborate coolant with long-life hybrid organic acid technology.

“Toyota Super Long Life Coolant” is a mixture of 50% coolant and 50% deionized water. (Minimum temperature: -31°F [-35°C])

For more details about coolant, contact your Toyota dealer.

■ **If the coolant level drops within a short time of replenishing**

Visually check the radiator, hoses, power control unit coolant reservoir caps, drain cock and water pump.

If you cannot find a leak, have your Toyota dealer, test the cap and check for leaks in the cooling system.

! WARNING

■ **When the heater system is hot**

Do not remove the heater coolant reservoir caps.

The heater system may be under pressure and may spray hot coolant if the cap is removed, causing serious injuries, such as burns.

! NOTICE

■ **When adding coolant**

Coolant is neither plain water nor straight antifreeze. The correct mixture of water and antifreeze must be used to provide proper lubrication, corrosion protection and cooling. Be sure to read the antifreeze or coolant label.

■ **If you spill coolant**

Be sure to wash it off with water to prevent it from damaging parts or paint.

Checking the radiator and condenser

Check the radiator and condenser and clear away any foreign objects.

If either of the above parts is extremely dirty or you are not sure of their condition, have your vehicle inspected Toyota dealer.

! WARNING

■ **When the EV system is hot**

Do not touch the radiator or condenser as they may be hot and cause serious injuries, such as burns.

⚠ WARNING**■ When the electric cooling fan are operating**

Do not touch the motor compartment.

With the power switch in ON, the electric cooling fan may automatically start to run if the air conditioning is on and/or the coolant temperature is high. Be sure the power switch is OFF when working near the electric cooling fan or radiator grille.

Checking the power control unit coolant

The coolant level is satisfactory if it is between the “MAX” and “MIN” lines on the reservoir when the EV system is cold.

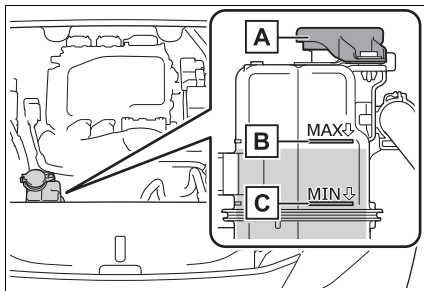

A Reservoir cap

B “MAX” line

C “MIN” line

If the level is on or below the “MIN” line, add coolant up to the “MAX” line.

■ Coolant selection

In order to ensure maximum performance of the traction battery cooling system and limit risks of battery short-circuit and other damage to

your vehicle, Toyota recommends using “Toyota Genuine Traction Battery Coolant” or similar high-quality ethylene glycol-based, low electric conductivity coolant, non-amine and non-borate coolant withazole additives.

Toyota cannot guarantee that the use of a product other than “Toyota Genuine Traction Battery Coolant” will prevent risks of battery short-circuit or other damage.

Never use water as it will cause damage.

Do not reuse coolant that has been removed from the radiator.

For more details about coolant, contact your Toyota dealer.

■ If the coolant level drops within a short time of replenishing

Visually check the hoses, heater coolant reservoir caps, drain cock and water pump.

If you cannot find a leak, have your Toyota dealer, test the cap and check for leaks in the cooling system.

⚠ WARNING**■ When the EV system is hot**

Do not remove the power control unit coolant reservoir caps.

The cooling system may be under pressure and may spray hot coolant if the cap is removed, causing serious injuries, such as burns.

 **NOTICE**

■ **When adding coolant**
Coolant is neither plain water nor straight antifreeze. The correct mixture of water and antifreeze must be used to provide proper lubrication, corrosion protection and cooling. Be sure to read the antifreeze or coolant label.

■ **If you spill coolant**
Be sure to wash it off with water to prevent it from damaging parts or paint.

Checking and adding the brake fluid

■ **Checking fluid level**
The brake fluid level should be between the “MAX” and “MIN” lines on the tank.

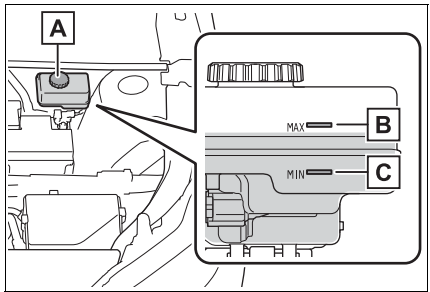

- A** Reservoir cap
- B** “MAX” line
- C** “MIN” line

■ **Adding fluid**
Make sure to check the fluid type and prepare the necessary item.

- Fluid type
FMVSS No.116 DOT 3 or SAE

J1703 brake fluid
FMVSS No.116 DOT 4 or SAE
J1704 brake fluid

- Item
Clean funnel

■ **Brake fluid can absorb moisture from the air**
Excess moisture in the brake fluid can cause a dangerous loss of braking efficiency. Use only newly opened brake fluid.

 **WARNING**

■ **When filling the reservoir**
Take care as brake fluid can harm your hands and eyes and damage painted surfaces.
If fluid gets on your hands or in your eyes, flush the affected area with clean water immediately. If you still experience discomfort, see a doctor.

 **NOTICE**

■ **If the fluid level is low or high**
It is normal for the brake fluid level to go down slightly as the brake pads wear out or when the fluid level in the accumulator is high.
If the reservoir needs frequent refilling, there may be a serious problem.

Checking the 12-volt battery

Check the 12-volt battery as follows.

■ **12-volt battery exterior**
Make sure that the 12-volt battery terminals are not corroded

and that there are no loose connections, cracks, or loose clamps.

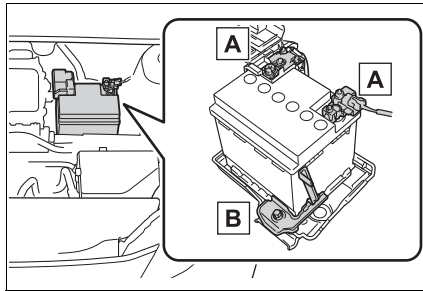

A Terminals

B Hold-down clamp

■ Checking 12-volt battery fluid

Check that the level is between the “UPPER LEVEL” and “LOWER LEVEL” lines.

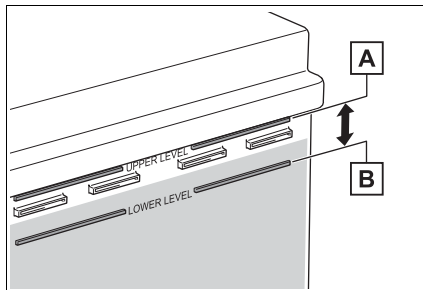

A “UPPER LEVEL” line

B “LOWER LEVEL” line

If the fluid level is at or below the “LOWER LEVEL” line, add distilled water.

■ Adding distilled water

- 1 Remove the vent plug.
- 2 Add distilled water.

If the “UPPER LEVEL” cannot be seen, check the fluid level by look-

ing directly at the cell.

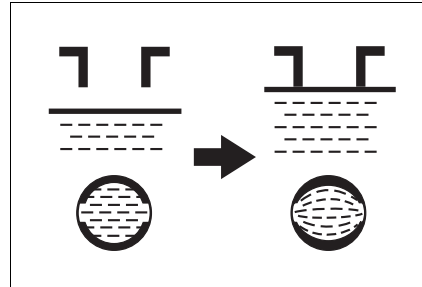

- 3 Put the vent plug back on and close it securely.

■ Before recharging

When recharging, the 12-volt battery produces hydrogen gas which is flammable and explosive. Therefore, observe the following precautions before recharging:

- If recharging with the 12-volt battery installed on the vehicle, be sure to disconnect the ground cable.
- Make sure the power switch on the charger is off when connecting and disconnecting the charger cables to the 12-volt battery.

■ After recharging/reconnecting the 12-volt battery

- The EV system may not start. Follow the procedure below to initialize the system.
 - 1 Shift the shift position to P.
 - 2 Open and close any of the doors.
 - 3 Restart the EV system.
- Unlocking the doors using the Smart key system may not be possible immediately after reconnecting the 12-volt battery. If this happens, use the wireless remote control or the mechanical key to lock/unlock the doors.
- Start the EV system with the power switch in ACC. The EV system may not start with the power switch turned off. However, the EV system will operate normally from

the second attempt.

- The power switch mode is recorded by the vehicle. If the 12-volt battery is disconnected and reconnected, the vehicle will return the power switch mode to the status it was in before the 12-volt battery was disconnected. Make sure to turn off the power switch before disconnecting the 12-volt battery. Take extra care when connecting the 12-volt battery if the power switch mode prior to the 12-volt battery being disconnected is unknown.

If the EV system will not start even after multiple attempts at all the methods above, contact your Toyota dealer.

 **WARNING**

■ **Chemicals in the 12-volt battery**

Batteries contain poisonous and corrosive sulfuric acid and may produce hydrogen gas which is flammable and explosive. To reduce the risk of death or serious injury, take the following precautions while working on or near the 12-volt battery:

- Do not cause sparks by touching the 12-volt battery terminals with tools.
- Do not smoke or light a match near the 12-volt battery.
- Avoid contact with eyes, skin and clothes.
- Never inhale or swallow electrolyte.
- Wear protective safety glasses when working near the 12-volt battery.
- Keep children away from the 12-volt battery.

■ **Where to safely charge the 12-volt battery**

Always charge the 12-volt battery in an open area. Do not charge the 12-volt battery in a garage or closed room where there is insufficient ventilation.

■ **Emergency measures regarding electrolyte**

- If electrolyte gets in your eyes
Flush your eyes with clean water for at least 15 minutes and get immediate medical attention. If possible, continue to apply water with a sponge or cloth while traveling to the nearest medical facility.
- If electrolyte gets on your skin
Wash the affected area thoroughly. If you feel pain or burning, get medical attention immediately.
- If electrolyte gets on your clothes
It can soak through clothing on to your skin. Immediately take off the clothing and follow the procedure above if necessary.
- If you accidentally swallow electrolyte
Drink a large quantity of water or milk. Get emergency medical attention immediately.

■ **When there is insufficient 12-volt battery fluid**

Do not use if there is insufficient fluid in the 12-volt battery. There is a possible danger that the 12-volt battery may explode.

⚠ NOTICE**■ When recharging the 12-volt battery**

Never recharge the 12-volt battery while the EV system is operating. Also, be sure all accessories are turned off.

■ When adding distilled water

Avoid overfilling. Water spilled during 12-volt battery recharging may cause corrosion.

Adding the washer fluid

If the warning message appears on the multi-information display, the washer tank may be empty. Add washer fluid.

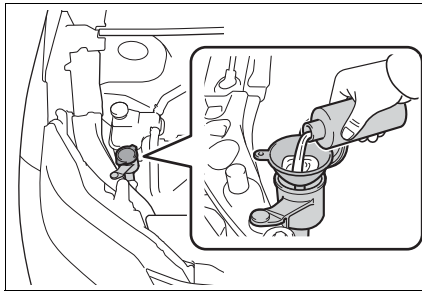
**⚠ WARNING****■ When adding washer fluid**

Do not add washer fluid when the EV system is hot or operating as washer fluid contains alcohol and may catch fire if spilled on the motor, etc.

⚠ NOTICE**■ Do not use any fluid other than washer fluid**

Do not use soapy water or anti-freeze instead of washer fluid. Doing so may cause streaking on the vehicle's painted surfaces, as well as damaging the pump leading to problems of the washer fluid not spraying.

■ Diluting washer fluid

Dilute washer fluid with water as necessary. Refer to the freezing temperatures listed on the label of the washer fluid bottle.

Tires

Replace or rotate tires in accordance with maintenance schedules and treadwear.

Checking tires

Check if the treadwear indicators are showing on the tires. Also check the tires for uneven wear, such as excessive wear on one side of the tread.

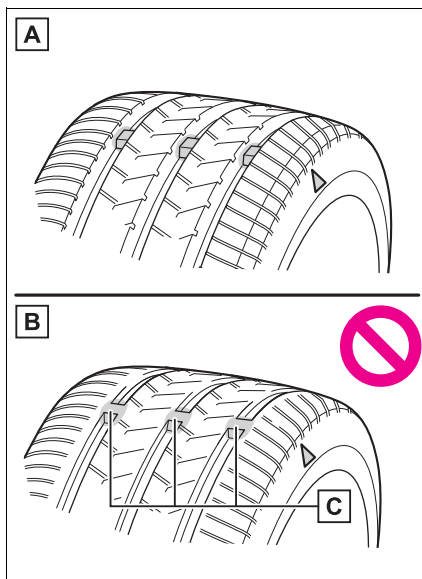

A New tread

B Worn tread

C Treadwear indicator

The location of treadwear indicators is shown by a “TWI” or “△” mark, etc., molded into the sidewall of each tire.

Replace the tires if the treadwear indicators are showing on a tire.

■ When to replace your vehicle's tires

Tires should be replaced if:

- The treadwear indicators are showing on a tire.
- You have tire damage such as cuts, splits, cracks deep enough to expose the fabric, and bulges indicating internal damage.
- A tire goes flat repeatedly or cannot be properly repaired due to the size or location of a cut or other damage.

If you are not sure, consult with your Toyota dealer.

■ Tire life

Any tire over 6 years old must be checked by a qualified technician even if it has seldom or never been used or damage is not obvious.

■ Maximum load of tire

Check that the number given by dividing the maximum load by 1.10 of the replacement tire is greater than 1/2 of the Gross Axle Weight Ratings (GAWR) of either the front axle or the rear axle, whichever is greater.

For the GAWR, see the Certification Regulation Label. For the maximum load of the tire, see the load limit at maximum cold tire inflation pressure mentioned on the sidewall of the tire. (→P.556)

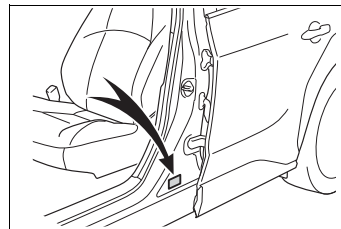

■ Tire types

- Summer tires

Summer tires are high-speed performance tires best suited to highway driving under dry conditions. Since summer tires do not have the same traction performance as snow tires, summer tires are inadequate for driving on snow-covered or icy roads. For driving on snow-covered roads or icy roads, the use of snow tires is recommended. When installing snow tires, be sure to replace all four tires.

● **All season tires**

All season tires are designed to provide better traction in snow and to be adequate for driving in most winter conditions as well as for use year-round. All season tires, however, do not have adequate traction performance compared with snow tires in heavy or loose snow. Also, all season tires fall short in acceleration and handling performance compared with summer tires in highway driving.

● **Snow tires**

For driving on snow-covered roads or icy roads, we recommend using snow tires. If you need snow tires, select tires of the same size, construction and load capacity as the originally installed tires. Since your vehicle has radial tires as original equipment, make sure your snow tires also have radial construction. Do not install studded tires without first checking local regulations for possible restrictions. Snow tires should be installed on all wheels. (→P.393)

■ **If the tread on snow tires wears down below 0.16 in. (4 mm)**

The effectiveness of the tires as snow tires is lost.

 **WARNING**

■ **When inspecting or replacing tires**

Observe the following precautions to prevent accidents. Failure to do so may cause damage to parts of the drive train as well as dangerous handling characteristics, which may lead to an accident resulting in death or serious injury.

- Do not mix tires of different makes, models or tread patterns. Also, do not mix tires of remarkably different treadwear.
- Do not use tire sizes other than those recommended by Toyota.
- Do not mix differently constructed tires (radial, bias-belted or bias-ply tires).
- Do not mix summer, all season and snow tires.
- Do not use tires that have been used on another vehicle. Do not use tires if you do not know how they were used previously.

 **NOTICE**

■ **Driving on rough roads**

Take particular care when driving on roads with loose surfaces or potholes. These conditions may cause losses in tire inflation pressure, reducing the cushioning ability of the tires. In addition, driving on rough roads may cause damage to the tires themselves, as well as the vehicle's wheels and body.



NOTICE

■ **If tire inflation pressure of each tire becomes low while driving**

Do not continue driving, or your tires and/or wheels may be ruined.

Tire rotation

Rotate the tires in the order shown.

To equalize tire wear and extend tire life, Toyota recommends that tire rotation is carried out at the same interval as tire inspection.

Do not fail to initialize the tire pressure warning system after tire rotation.

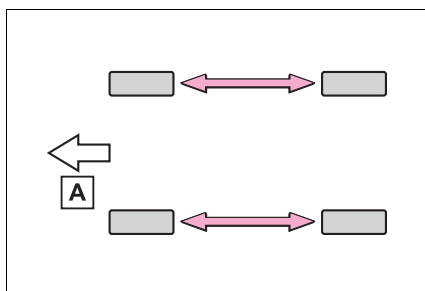

A Front

■ **When rotating the tires**

Make sure that the power switch is OFF. If the tires are rotated while the power switch is in ON, the tire position information will not be updated. If this accidentally occurs, either turn the power switch to OFF and then to ON, or initialize the system after checking that the tire pressure is properly adjusted.

Tire pressure warning system

Your vehicle is equipped with a tire pressure warning system that uses tire pressure warning valves and transmitters to detect low tire inflation pressure before serious problems arise.

The tire pressure warning system of this vehicle adopts a 2-type warning system.

- When “Adjust Pressure” is displayed (Normal Warning)

A warning with the tire pressure warning light and warning buzzer when there is an unknown level of low tire pressure with the appearance of the tire due to natural air leakage as well as the pressure lowering due to changes in the pressure according to the outside temperature.

- When “Immediately Check Tire when Safe” is displayed (Emergency Warning)

A warning with the tire pressure warning light and warning buzzer when there is a known level of low tire pressure with the appearance of the tire due to pressure suddenly lowering.

However, the system may not be able to detect sudden tire ruptures (bursting, etc.).

- The tire pressure detected by the tire pressure warning system can be displayed on the multi-information display.



■ How to change the unit

- 1 Park the vehicle in a safe place and EV system off.
 - 2 Start the EV system.
- Changing the unit cannot be performed while the vehicle is moving.
- 3 Press \wedge or \vee of the meter control switch to select .
 - 4 Press \leftarrow or \rightarrow of the meter control switches and select "Vehicle Settings" and then press and hold "OK".
 - 5 Press \wedge or \vee of the meter control switches and select "TPWS setting" and then press "OK".
 - 6 Press \wedge or \vee of the meter control switches and select "Setting Unit" and then press "OK".
 - 7 Press \wedge or \vee of the meter control switches and select the desired unit and then press "OK".

■ Routine tire inflation pressure checks

The tire pressure warning system does not replace routine tire inflation pressure checks. Make sure to check tire inflation pressure as part of your routine of daily vehicle checks.

■ Tire inflation pressure

- It may take a few minutes to display the tire inflation pressure after the power switch is turned on. It may also take a few minutes to display the tire inflation pressure after inflation pressure has been adjusted.
- Tire inflation pressure changes with temperature. The displayed values may also be different from the values measured using a tire pressure gauge.

■ Situations in which the tire pressure warning system may not operate properly

- In the following cases, the tire pressure warning system may not operate properly.
 - If non-genuine Toyota wheels are used.
 - A tire has been replaced with a tire that is not an OE (Original Equipment) tire.
 - A tire has been replaced with a tire that is not of the specified size.
 - Tire chains etc. are equipped.
 - If a window tint that affects the radio wave signals is installed.
 - If there is a lot of snow or ice on the vehicle, particularly around the wheels or wheel housings.
 - If the tire inflation pressure is extremely higher than the specified level.
 - If wheels without tire pressure warning valves and transmitters are used.
 - If the ID code on the tire pressure warning valves and transmitters is not registered in the tire pressure warning computer.

- Performance may be affected in the following situations.
- Near a TV tower, electric power plant, gas station, radio station, large display, airport or other facility that generates strong radio waves or electrical noise
- When carrying a portable radio, cellular phone, cordless phone or other wireless communication device

If tire position information is not correctly displayed due to the radio wave conditions, the display may be corrected by driving and changing the radio wave conditions.

- When the vehicle is parked, the time taken for the warning to start or go off could be extended.
- When tire inflation pressure declines rapidly for example when a tire has burst, the warning may not function.

Installing tire pressure warning valves and transmitters

When replacing tires or wheels, tire pressure warning valves and transmitters must also be installed.

When new tire pressure warning valves and transmitters are installed, new ID codes must be registered in the tire pressure warning computer and the tire pressure warning system must be initialized. (→P.481)

■ When replacing the tires and wheels

If the ID code of the tire pressure warning valve and transmitter is not registered, the tire pressure warning system will not work properly. After

driving for about 10 minutes, the tire pressure warning light blinks for 1 minute and stays on to indicate a system malfunction.

NOTICE

■ Repairing or replacing tires, wheels, tire pressure warning valves, transmitters and tire valve caps

- When removing or fitting the wheels, tires or the tire pressure warning valves and transmitters, contact your Toyota dealer as the tire pressure warning valves and transmitters may be damaged if not handled correctly.
- Make sure to install the tire valve caps. If the tire valve caps are not installed, water could enter the tire pressure warning valves and the tire pressure warning valves could be bound.
- When replacing tire valve caps, do not use tire valve caps other than those specified. The cap may become stuck.

■ To avoid damage to the tire pressure warning valves and transmitters

When a tire is repaired with liquid sealants, the tire pressure warning valve and transmitter may not operate properly. If a liquid sealant is used, contact your Toyota dealer as soon as possible. After use of liquid sealant, make sure to replace the tire pressure warning valve and transmitter when repairing or replacing the tire.

Registration of the position of each wheel after performing a tire rotation

■ When rotating the tires

It is necessary to register the position of each wheel after performing a tire rotation.

Wheel position registration can be performed by oneself. Wheel position registration is performed by driving forward with moderate left and right turns. However, depending on the driving conditions and driving environment, registration may take some time to complete.

■ Registration of the tire position

- 1 Park the vehicle in a safe place and stop the EV system for 15 minutes or more.
- 2 Start the EV system (→P.467)

Registration cannot be performed while the vehicle is moving.

- 3 Press \wedge or \vee of the meter control switches and select .
- 4 Press \langle or \rangle of the meter control switches and select "Vehicle Settings", and then press and hold the "OK".
- 5 Press \wedge or \vee of the meter control switches and select

"TPWS Setting", and then press "OK".

- 6 Press \wedge or \vee of the meter control switches and select "Tire Rotation", and then press "OK".
- 7 Press \wedge or \vee of the meter control switches and select "OK", and then press "OK".

A message is displayed on the multi-information display. Also, "--" is displayed for inflation pressure of each tire on the multi-information display while the tire pressure warning system determines the position.

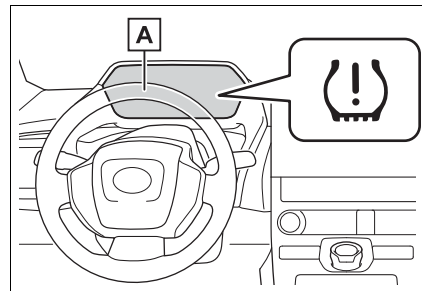

A "Setting Pressure Wait a Moment"

- 8 Drive at approximately 25 mph (40 km/h) or more for approximately 10 to 30 minutes.

When wheel position registration is complete, the inflation pressure of each tire will be displayed on the multi-information display.

Even if the vehicle is not driven at approximately 25 mph (40 km/h) or more, registration can be completed by driving for a long time. However, if initialization does not complete after driving for 1 hour or

more, park the vehicle in a safe place for approximately 15 minutes and then drive the vehicle again.

■ When performing wheel position registration

- Normally, wheel position registration can be completed within approximately 30 minutes.
- Wheel position registration is performed while driving at a vehicle speed of approximately 25 mph (40 km/h) or more.

■ The initialization operation

- If the power switch is turned off while registering the wheel position, the next time the power switch is turned to ON, the wheel position registration will resume and it will not be necessary to restart the procedure.
- While the position of each tire is being determined and the inflation pressures are not being displayed on the multi-information display, if the inflation pressure of a tire drops, the tire pressure warning light will come on.

■ If the tire pressure warning system is not registered properly

- In the following situations, wheel position registration may take longer than usual to be completed or may not be possible.
 - Vehicle is not driven at approximately 25 mph (40 km/h) or more
 - Vehicle is driven on unpaved roads

If initialization does not complete after driving for 1 hour or more, park the vehicle in a safe place for approximately 15 minutes and then drive the vehicle again.

- If the vehicle is reversed during wheel position registration, all data collected until then will be cleared. Perform driving again.

Setting the tire pressure

■ When you need to setting the tire pressure

In the following situations, it will be necessary to perform the tire inflation pressure setting procedure of the tire pressure warning system.

- When the specified tire inflation pressure has changed, such as due to carried load, etc.
- When the tire inflation pressure is changed such as when the tire size is changed.

If the tire inflation pressure has been adjusted to the specified level, perform the tire inflation setting procedure by selecting specified inflation pressure on the multi-information display.

When the tire inflation pressure is to be other than specified, such as when tires other than the specified size are used, etc., set the tire inflation pressure using the current pressure. Make sure to adjust the tire inflation pressure of each tire to the appropriate level before performing tire pressure setting. The tire pressure warning system operates based on this tire inflation pressure.

■ **Setting by selecting a specified tire inflation pressure**

- 1 Start the EV system (→P.231)

The tire inflation pressure cannot be set while the vehicle is moving.

- 2 Press **▲** or **▼** of the meter control switches and select .

- 3 Press **<** or **>** of the meter control switches and select “Vehicle Settings”, and then press and hold the “OK”.

- 4 Press **▲** or **▼** of the meter control switches and select “TPWS Setting”, and then press “OK”.

- 5 Press **▲** or **▼** of the meter control switches and select “Tire Pressure Setting”, and then press “OK”.

- 6 Press **▲** or **▼** of the meter control switches and select “Setting by Specified Pressure”, and then press “OK”.

Select the desired front and rear tire pressures.

- 7 Press **▲** or **▼** of the meter control switches and select “OK”, and then press “OK”.

The tire pressure warning light will slowly blink 3 times and a message indicating that tire inflation pressure is being set will be displayed on the multi-information display.

After setting the tire inflation pressure, a message indicating that setting has been completed will be displayed on the multi-information display.

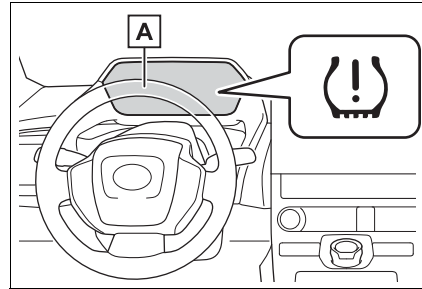

A “Setting Pressure Wait a Moment”

■ **Setting using the current tire inflation pressure**

- 1 Adjust the tire inflation pressure to the specified cold tire inflation pressure level.

Make sure to adjust the tire pressure to the specified cold tire inflation pressure level. The tire pressure warning system will operate based on this pressure level.

- 2 Start the EV system (→P.231)

The tire inflation pressure cannot be set while the vehicle is moving.

- 3 Press **▲** or **▼** of the meter control switches and select .

- 4 Press **<** or **>** of the meter control switches and select “Vehicle Settings”, and then press and hold the “OK”.

- 5 Press \wedge or \vee of the meter control switches and select "TPWS Setting", and then press "OK".
- 6 Press \wedge or \vee of the meter control switches and select "Tire Pressure Setting", and then press "OK".
- 7 Press \wedge or \vee of the meter control switches and select "Setting by Current Pressure" and then press "OK".
- 8 Press \wedge or \vee of the meter control switches and select "OK", and then press "OK".

The tire pressure warning light will slowly blink 3 times and a message indicating that tire inflation pressure is being set will be displayed on the multi-information display.

After setting the tire inflation pressure, a message indicating that setting has been completed will be displayed on the multi-information display.

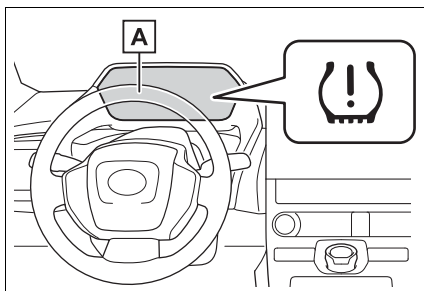

A "Setting Pressure Wait a Moment"

■ Warning performance of the tire pressure warning system (Setting using the current tire inflation pressure)

- When performing the tire pressure setting using the current tire inflation pressure, the warning timing of the tire pressure warning system will vary according to the conditions under which tire pressure setting was performed. Therefore, a warning may be output even if the tire inflation pressure drops slightly or if the tire inflation pressure increases above that when the tire inflation pressure was set.
- Make sure to perform the tire pressure setting procedure after adjusting the tire inflation pressure. Also, make sure the tires are cold before performing the tire pressure setting procedure or adjusting the tire inflation pressure.

■ Tire inflation pressure setting procedure (Setting using the current tire inflation pressure)

- If the power switch is turned off while setting the tire inflation pressure, the next time the power switch is turned to ON, the setting procedure will resume and it will not be necessary to restart the procedure.
 - If the tire inflation pressure setting procedure is started unnecessarily, adjust the tire inflation pressure to the specified level with the tires cold and then perform setting by selecting a specified tire inflation pressure, or perform the tire inflation pressure setting procedure with the current tire inflation pressure.
- **If the tire inflation pressure cannot be set properly**
- Normally, the tire inflation pressure setting procedure can be completed in 2 or 3 minutes.
 - If the tire pressure warning light

does not blink 3 times when starting the tire inflation pressure setting procedure, the procedure may not have started. Perform the procedure again from the beginning.

- If tire inflation pressure setting procedure cannot be completed after performing the above procedure, contact your Toyota dealer.

WARNING

■ **When setting using the current tire inflation pressure**

Make sure to adjust the tire inflation pressure of each tire to the appropriate level before performing tire pressure setting. Otherwise, the tire pressure warning light may not illuminate even if the tire inflation pressure drops or may illuminate even though the tire inflation pressure is normal.

Registering ID codes

■ **When the registering ID codes**

The tire pressure warning valve and transmitter is equipped with a unique ID code.











When new tire pressure warning valves and transmitters are installed, new ID codes must be registered in the tire pressure warning computer.

■ **How to registration ID code**



- 1** Park the vehicle in a safe place, wait for approximately 15 minutes.
- 2** Start the EV system.
(→P.231)

The ID code registration procedure

cannot be performed while the vehicle is moving.

- 3** Press  or  of the meter control switches and select .
- 4** Press  or  of the meter control switches and select “Vehicle Settings”, and then press and hold the “OK”.
- 5** Press  or  of the meter control switches and select “TPWS Setting”, and then press “OK”.
- 6** Press  or  of the meter control switches and select “Tire Set Switching”, and then press “OK”.
- 7** Press  or  of the meter control switches and select “Register New Valve/ID” and then press “OK”.
- 8** Check if the desired wheel set (“Tire Set 1” or “Tire Set 2”) is displayed.

ID codes will be registered to the displayed wheel set.

To change the wheel set to be registered, press  or  of the meter control switches, and then select the wheel set you wish to register.

If ID codes have already been registered for that wheel set, the tire pressure warning light will slowly blink 3 times, and a message indicating that change is occurring will

be displayed on the multi-information display.

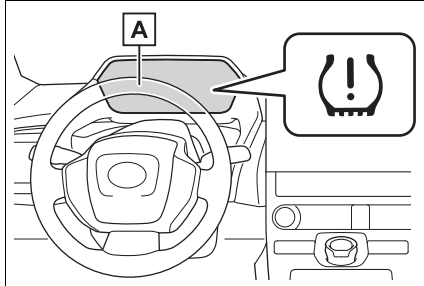

A "Setting Pressure Wait a Moment"

- 9 Press \wedge or \vee of the meter control switches and select "OK" and then press "OK".

The tire pressure warning light will slowly blink 3 times and a message indicating that ID code registration is being performed will be displayed on the multi-information display. Wheel set changing will be canceled and registration will begin.

When registration is being performed, the tire pressure warning light will blink for approximately 1 minute then illuminate and "--" will be displayed for the inflation pressure of each tire on the multi-information display.

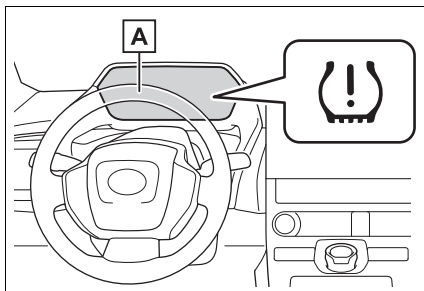

A "Setting Pressure Wait a Moment"

- 10 Drive straight (with occasional left and right turns) at approximately 25 mph (40 km/h) or more for approximately 10 to 30 minutes.

When registration is complete, the tire pressure warning light will turn off and a message indicating that registration has been completed will be displayed on the multi-information display.

Registration may take longer than normal to complete if the vehicle speed cannot be maintained at approximately 25 mph (40 km/h) or more. If registration cannot be completed after driving for 1 hour or more, perform the registration procedure again from the beginning.

■ **When registering ID codes**

- Normally, wheel position registration can be completed within approximately 30 minutes.
- ID code registration is performed while driving at a vehicle speed of approximately 25 mph (40 km/h) or more.
- ID codes can be registered by yourself, but depending on the driving conditions and driving environment, registration may take some time to complete.
- When using a wheel set which all of the ID codes have already been registered, the wheel set can be changed in a short amount of time.

■ **If ID codes are not registered properly**

- In the following situations, ID code registration may take longer than usual to be completed or may not be possible.
 - When the vehicle has not been parked for approximately 15 minutes or more before being driven
 - Vehicle is not driven at approximately 25 mph (40 km/h) or more

- Vehicle is driven on unpaved roads
- Vehicle is driven near other vehicles and system cannot recognize tire pressure warning valves and transmitters of your vehicle over those of other vehicles
- Wheel with tire pressure warning valve and transmitter installed is inside or near the vehicle
- If the vehicle is reversed during registration, all data collected until then will be cleared. Perform driving again.
- If registration does not complete after driving for 1 hour or more, perform the ID code registration procedure again from the beginning.
- If the tire pressure warning light does not blink 3 times when starting ID code registration procedure, the procedure may not have started. Perform the procedure again from the beginning.
- If ID codes cannot be registered even when performing the above procedure, contact your Toyota dealer.

Canceling ID code registration

To cancel ID code registration after it has been started, select "Register New Valve / ID" again on the multi-information display.

If ID code registration has been canceled, the tire pressure warning light will turn off.

If the warning light does not turn off, ID code registration may not have been cancelled correctly.

To cancel registration, select "Register New Valve / ID" again on the multi-information display.

Selecting wheel set

Your vehicle is equipped with a tire pressure warning system with a function to register two sets of ID codes. This allows for registration of a second wheel set, for example a winter set.

- The wheel set can be changed only if a second wheel set has been registered to the system. If a second wheel set has not been registered, message will be displayed and it will not be possible to change to the selected wheel set. ID codes can be registered by yourself.
- Only a change between both registered wheel set is possible, mixing between these wheel sets is not supported.
- While registering ID codes, it may not be possible to change between wheel sets normally. Cancel registration before changing between wheel sets.

How to change between wheel sets

- 1 Install the desired wheel set.
- 2 Start the EV system. (→P.231)

The ID code selecting procedure cannot be performed while the vehicle is moving.

- 3 Press \wedge or \vee of the meter control switches and select .
- 4 Press \langle or \rangle of the meter control switches and select "Vehicle Settings", and then press and hold the "OK".
- 5 Press \wedge or \vee of the meter control switches and select "TPWS Setting", and then press "OK".
- 6 Press \wedge or \vee of the meter control switches and select "Tire Set Switching", and then press "OK".
- 7 Press \wedge or \vee of the meter control switches and select "Register Valve/ID" and then press "OK".
- 8 Press \wedge or \vee of the meter control switches and wheel set ("Tire Set 1" or "Tire Set 2") is selected.
- 9 Press \wedge or \vee of the meter control switches and select "OK" and then press "OK". The tire pressure warning light will slowly blink 3 times, a message indicating that change is occurring will be displayed, and the wheel set change will begin.

Wheel set change will begin and the tire pressure warning light will blink for 1 minute and then illuminate. Also, while the change is being performed, "--" will be displayed for the tire inflation pressure of each tire on the multi-information display.

After approximately 2 minutes, the wheel set change will complete, the tire pressure warning light will turn off, and a completion message will be displayed on the multi-information display.

If changing does not complete after approximately 4 minutes, a message indicating that the change could not be completed will be displayed.

Check which wheel set is installed and perform the change procedure again from the beginning.

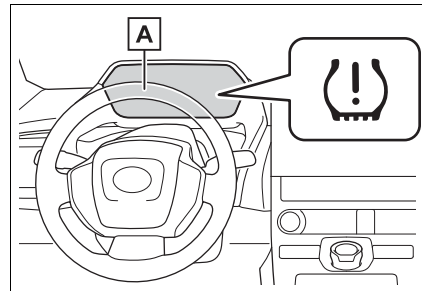

A "Setting Pressure Wait a Moment"

- 10 If the specified tire inflation pressure of the wheel set installed differs from that of the previous set, it will be necessary to perform the tire inflation pressure setting procedure of the tire pressure warning system.

If the specified tire inflation pressure is the same, it will not be necessary to perform the tire inflation pressure setting procedure.

1 1 Register the position of each wheel.

Replacing the tire

When raising your vehicle with a jack, position the jack correctly.

Improper placement may damage your vehicle or cause injury.

If necessary tire replacement seems difficult to perform, contact your Toyota dealer.

Before jacking up the vehicle

- Stop the vehicle in a safe place on a hard, flat surface.
- Set the parking brake.
- Shift the shift position to P.
- Stop the EV system.
- Vehicles with power back door: Turn off the power back door system. (→P.185)

■ Tools

As your vehicle is equipped with an emergency tire puncture repair kit, the following tools for replacing a tire are not included with your vehicle. They can be purchased your Toyota dealer.

- Jack
- Jack handle

Location of the tools

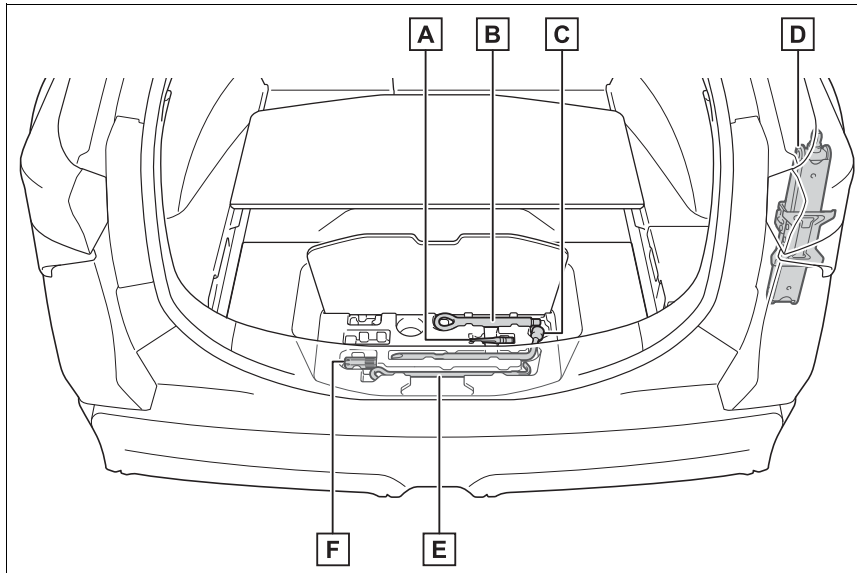

- A** Guide pin*
- B** Towing eyelet
- C** Wheel bolt wrench
- D** Jack*
- E** Jack handle*
- F** Wheel bolt socket*

*: They can be purchased your Toyota dealer.

⚠ WARNING

■ Using the tire jack

Observe the following precautions.

Improper use of the tire jack may cause the vehicle to suddenly fall off the jack, leading to death or serious injury.

- Do not use the tire jack for any purpose other than replacing tires or installing and removing tire chains.

- Do not use other tire jacks for replacing tires on this vehicle.
- Put the jack properly in its jack point.
- Do not put any part of your body under the vehicle while it is supported by the jack.
- Do not start the EV system or drive the vehicle while the vehicle is supported by the jack.

⚠ WARNING

- Do not raise the vehicle while someone is inside.
- When raising the vehicle, do not put an object on or under the jack.
- Do not raise the vehicle to a height greater than that required to replace the tire.
- Use a jack stand if it is necessary to get under the vehicle.
- When lowering the vehicle, make sure that there is no-one near the vehicle. If there are people nearby, warn them vocally before lowering.

Replacing a flat tire

1 Check the tires.

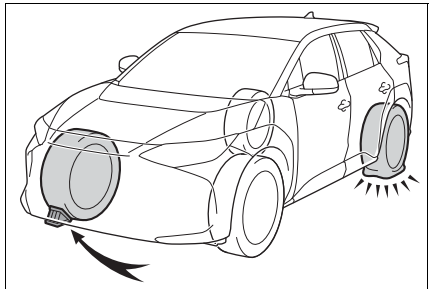

| Tire | Wheel chock positions |
|------------------|--------------------------------------|
| Front left-hand | Behind the rear right-hand side tire |
| Front right-hand | Behind the rear left-hand side tire |

| Tire | Wheel chock positions |
|-----------------|--|
| Rear left-hand | In front of the front right-hand side tire |
| Rear right-hand | In front of the front left-hand side tire |

2 Slightly loosen the wheel bolts (one turn).

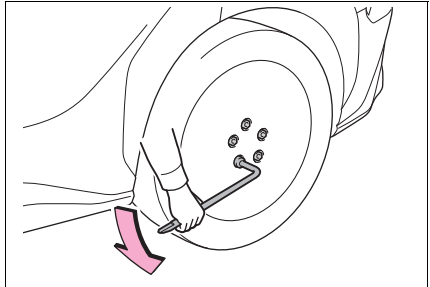

3 Turn the **A** part of the jack by hand and place the top of the jack in the position shown in the illustration.

► Front

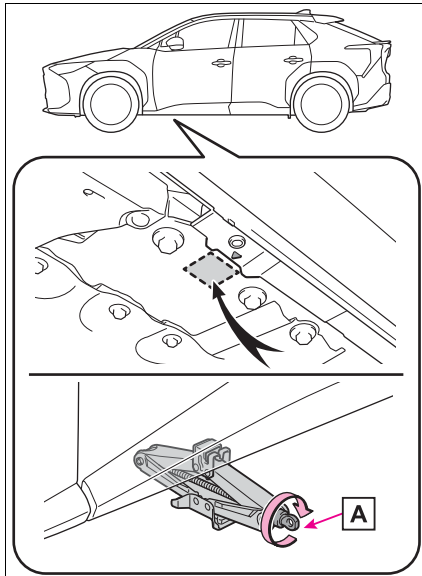

► Rear

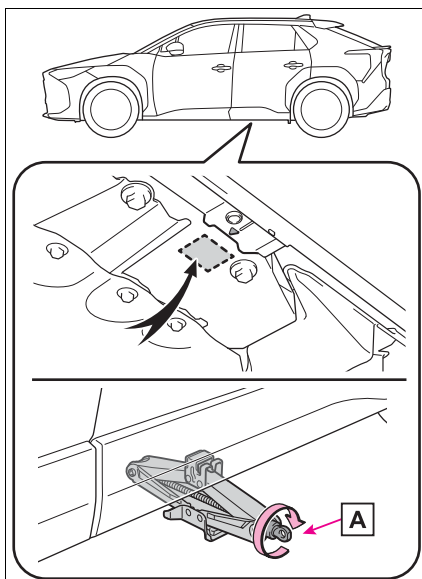

4 Install the wheel bolt wrench in jack handle.

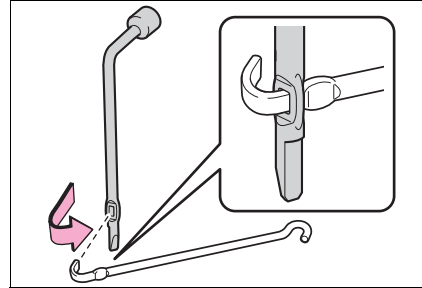

5 Raise the vehicle until the tire is slightly raised off the ground.

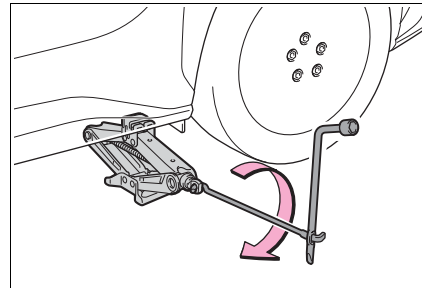

6 Remove all the wheel bolts and the tire.

When resting the tire on the ground, place the tire so that the wheel design faces up to avoid scratching the wheel surface.

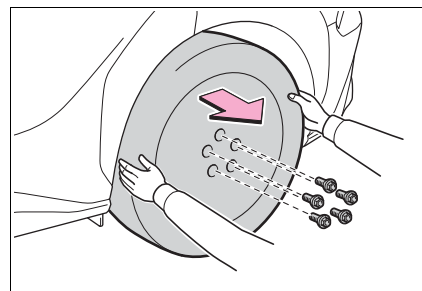

⚠ WARNING

■ **Replacing a flat tire**

- Do not touch the disc wheels or the area around the brakes immediately after the vehicle has been driven.

After the vehicle has been driven the disc wheels and the area around the brakes will be extremely hot. Touching these areas with hands, feet or other body parts while changing a tire, etc. may result in burns.

- Failure to follow these precautions could cause the wheel bolts to loosen and the tire to fall off, resulting in death or serious injury.

- Never apply oil or grease to the wheel bolts or their contact surface on the wheel **A**.

Doing so may cause the wheel bolts to be tightened excessively, leading to damage to the wheel bolts, the threaded portion the wheel bolts install to **B**, or the wheel.

Also, the wheel bolts may come loose, possibly leading to the wheel coming off, causing a serious accident.

If oil or grease is attached to either of these parts, remove it.

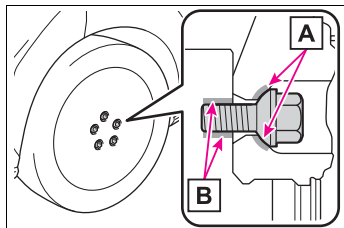

- When installing a wheel, use the same wheel bolts that were removed with the wheel. Also, do not use any wheel bolts other than Toyota Genuine wheel bolts.

- If a wheel bolt hole in a wheel or the threads of a wheel bolt or the wheel hub are deformed, cracked, rusty or otherwise damaged, have the vehicle inspected by your Toyota dealer.

■ **When tightening the wheel bolts**

Do not tighten the wheel bolts excessively. Doing so may cause the wheel bolts, the threads of the wheel hub, or the wheel to be damaged.

■ **Replacing a flat tire for vehicles with power back door**

In cases such as when replacing tires, make sure to cancel the power back door system (→P.185). Failure to do so may cause the back door to operate unintentionally if the power back door switch is accidentally touched, resulting in hands and fingers being caught and injured.

⚠ NOTICE

- **Repairing or replacing tires, wheels, tire pressure warning valves, transmitters and tire valve caps**

→P.476

Installing the tire

- 1 Remove any dirt or foreign matter from the wheel contact surface.

If foreign matter is on the wheel

contact surface, the wheel bolts may loosen while the vehicle is in motion, causing the tire to come off.

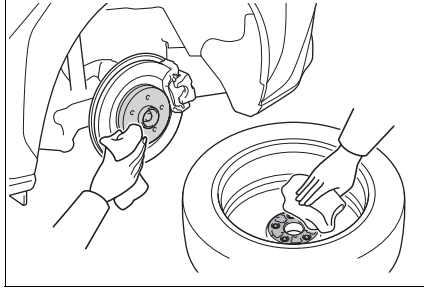

- 2 Install the tire and loosely tighten each wheel bolts by hand by approximately the same amount.

Tighten the wheel bolts until the spherical portion **A** comes into loose contact with the disc wheel seat **B**.

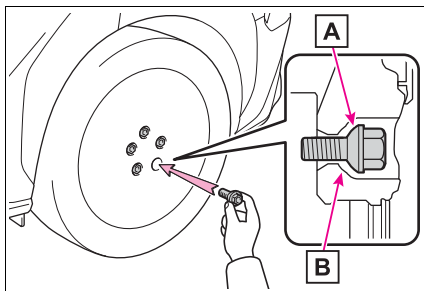

- A** Spherical portion
- B** Disc wheel

- 3 Lower the vehicle.

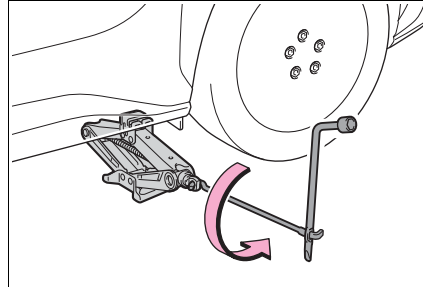

- 4 Firmly tighten each wheel bolt two or three times in the order shown in the illustration.

Tightening torque:
103 ft•lbf (140N•m, 14.3 kgf•m)

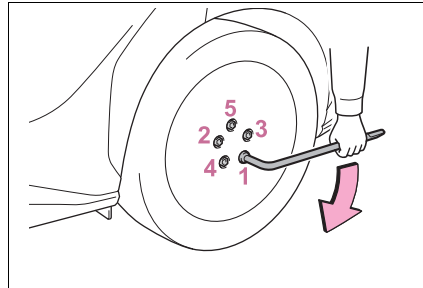

- 5 Stow all the tools.

Tire inflation pressure

Make sure to maintain the proper tire inflation pressure. Tire inflation pressure should be checked at least once per month. However, Toyota recommends that tire inflation pressure be checked once every two weeks. (→P.555)

Checking the specified tire inflation pressure

The recommended cold tire inflation pressure and tire size are displayed on the tire and loading information label. (→P.555)

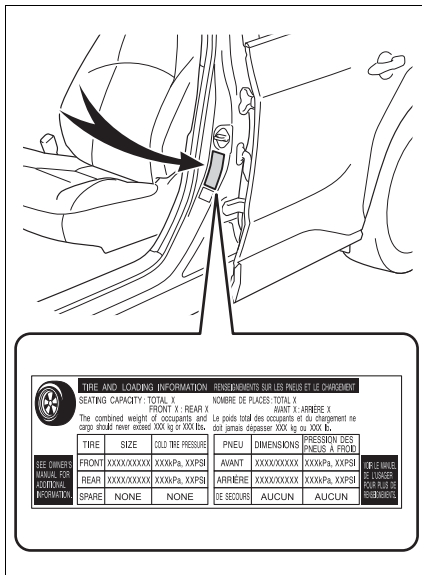

Inspection and adjustment procedure

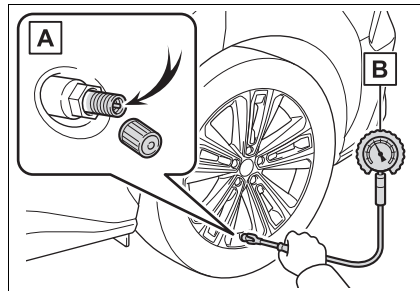

A Tire valve

B Tire pressure gauge

- 1 Remove the tire valve cap.
- 2 Press the tip of the tire pressure gauge onto the tire valve.
- 3 Read the pressure using the gauge gradations.
- 4 If the tire inflation pressure is not at the recommended level, adjust the pressure. If you add too much air, press the center of the valve to deflate.
- 5 After completing the tire inflation pressure measurement and adjustment, apply soapy water to the valve and check for leakage.
- 6 Put the tire valve cap back on.

■ Tire inflation pressure check interval

You should check tire inflation pressure every two weeks, or at least once a month.

■ **Effects of incorrect tire inflation pressure**

Driving with incorrect tire inflation pressure may result in the following:

- Reduced electricity consumption
- Reduced driving comfort and poor handling
- Reduced tire life due to wear
- Reduced safety
- Damage to the drive train

If a tire needs frequent inflating, have it checked by your Toyota dealer.

■ **Instructions for checking tire inflation pressure**

When checking tire inflation pressure, observe the following:

- Check only when the tires are cold.
If your vehicle has been parked for at least 3 hours or has not been driven for more than 1 mile or 1.5 km, you will get an accurate cold tire inflation pressure reading.
- Always use a tire pressure gauge. It is difficult to judge if a tire is properly inflated based only on its appearance.
- It is normal for the tire inflation pressure to be higher after driving as heat is generated in the tire. Do not reduce tire inflation pressure after driving.
- Never exceed the vehicle capacity weight. Passengers and luggage weight should be placed so that the vehicle is balanced.

 **WARNING**

■ **Proper inflation is critical to save tire performance**

Keep your tires properly inflated. If the tires are not properly inflated, the following conditions may occur which could lead to an accident resulting in death or serious injury:

- Excessive wear
- Uneven wear
- Poor handling
- Possibility of blowouts resulting from overheated tires
- Air leaking from between tire and wheel
- Wheel deformation and/or tire damage
- Greater possibility of tire damage while driving (due to road hazards, expansion joints, sharp edges in the road, etc.)

 **NOTICE**

■ **When inspecting and adjusting tire inflation pressure**

Be sure to put the tire valve caps back on. If a valve cap is not installed, dirt or moisture may get into the valve and cause an air leak, resulting in decreased tire inflation pressure.

Wheels

If a wheel is bent, cracked or heavily corroded, it should be replaced. Otherwise, the tire may separate from the wheel or cause a loss of handling control.

Wheel selection

When replacing wheels, care should be taken to ensure that they are equivalent to those removed in load capacity, diameter, rim width and inset*.

Replacement wheels are available at your Toyota dealer.

*: Conventionally referred to as offset.

Toyota does not recommend using the following:

- Wheels of different sizes or types
- Used wheels
- Bent wheels that have been straightened

When replacing wheels

The wheels of your vehicle are equipped with tire pressure warning valves and transmitters that allow the tire pressure warning system to provide advance warning in the event of a loss in tire inflation pressure. Whenever wheels are replaced, tire pressure warning valves and transmitters must be installed. (→P.476)

⚠ WARNING**When replacing wheels**

- Do not use wheels that are a different size from those recommended in the Owner's Manual, as this may result in a loss of handling control.
- Never use an inner tube in a leaking wheel which is designed for a tubeless tire. Doing so may result in an accident, causing death or serious injury.

Wheel bolts

Observe the following precautions to reduce the risk of death or serious injury:

- Do not over tighten.
- Never use oil or grease on the wheel bolts. Oil and grease may cause the wheel bolts to be excessively tightened, leading to bolt or disc wheel damage. In addition, the oil or grease can cause the wheel bolts to loosen and the wheel may fall off, causing a serious accident. Remove any oil or grease from the wheel bolts.
- If there are any cracks or deformations in the wheel bolts, or if the surface treatment becomes worn, have the wheel bolts replaced at your Toyota dealer. Failure to follow these precautions could cause the wheel bolts to loosen and the tire to fall off, resulting in death or serious injury.

Use of defective wheels prohibited

Do not use cracked or deformed wheels.

Doing so could cause the tire to leak air during driving, possibly causing an accident.

 NOTICE

■ Replacing tire pressure warning valves and transmitters

- Because tire repair or replacement may affect the tire pressure warning valves and transmitters, make sure to have tires serviced by your Toyota dealer or other qualified service shop. In addition, make sure to purchase your tire pressure warning valves and transmitters at your Toyota dealer.
- Ensure that only genuine Toyota wheels are used on your vehicle. Tire pressure warning valves and transmitters may not work properly with non-genuine wheels.

Aluminum wheel precautions

- Use only Toyota wheel bolts and wrenches designed for use with your aluminum wheels.
- When rotating, repairing or changing your tires, check that the wheel bolts are still tight after driving 1000 miles (1600 km).
- Be careful not to damage the aluminum wheels when using tire chains.
- Use only Toyota genuine balance weights or equivalent and a plastic or rubber hammer when balancing your wheels.

Air conditioning filter

The air conditioning filter must be changed regularly to maintain air conditioning efficiency.

Removal method

- 1 Turn the power switch off.

Confirm that the charging connector is not connected. Also, do not use the Remote Air Conditioning System during the procedure.

- 2 Open the front passenger's door.

By keeping the door open, unexpected operation of the Remote Air Conditioning System can be prevented. (→P.409)

- 3 While pressing the claw, hold handle **A** and remove the panel.

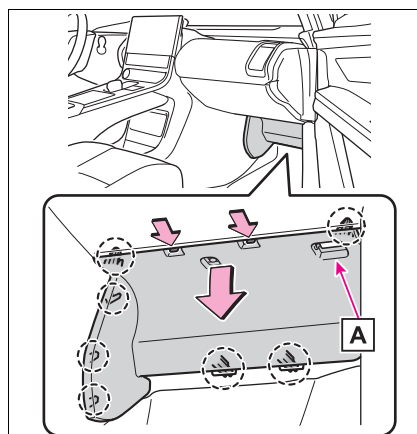

- 4 Vehicles with footwell lights:
Unplug the connector.

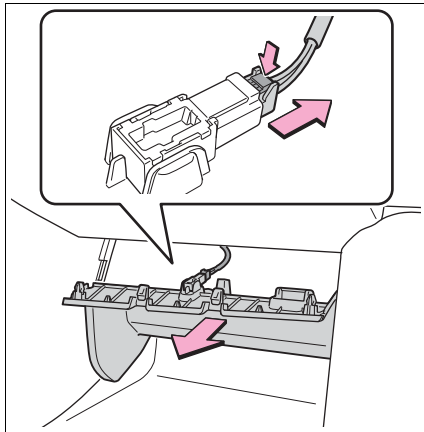

- 5 Unlock the filter cover (A), pull the filter cover out of the claws (B), and remove the filter cover.

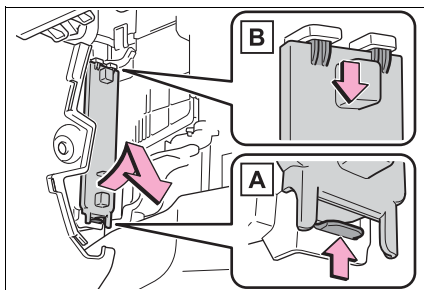

- 6 Hold the filter case A and remove the lower filter case.

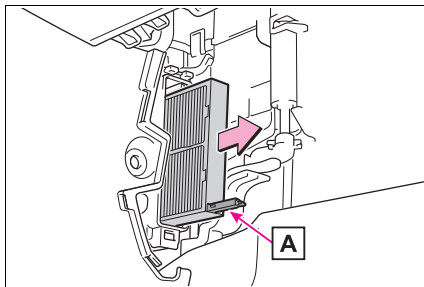

- 7 Hold the filter case A and pull down the upper filter case.

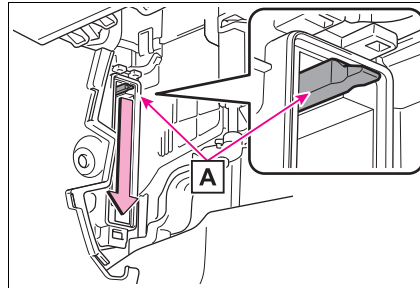

- 8 Hold the filter case A and remove the upper filter case.

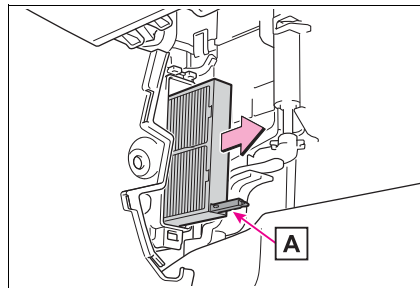

- 9 Remove the air conditioning filter from the upper and lower filter case and replace it with a new one.

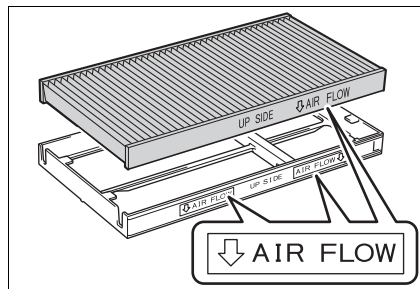

Install so that the arrow points to the rear of the vehicle.

- 10 When installing, reverse the steps listed.

■ **When installing the filter cover**

Slide the recessed part **A** of the filter cover on the upper surface of the upper filter case **B** as shown in the figure, and attach it so that it is lifted toward the insertion part of the cover attachment.

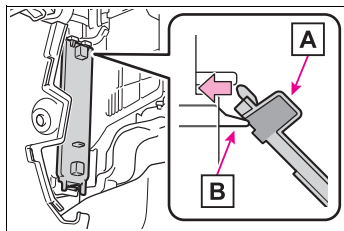

■ **Checking interval**

Inspect and replace the air conditioning filter according to the maintenance schedule. In dusty areas or areas with heavy traffic flow, early replacement may be required. (For scheduled maintenance information, please refer to the "Owner's Manual Supplement" or "Scheduled Maintenance".)

■ **If air flow from the vents decreases dramatically**

The filter may be clogged. Check the filter and replace if necessary.

⚠ WARNING

■ **When replacing the air conditioning filter**

Observe the following precautions. Failure to do so may result in the air conditioning system operating during the procedure, possibly resulting in injury.

- Check that the charging connector is not connected
- Do not use the Remote Air Conditioning System

⚠ NOTICE

■ **When using the air conditioning system**

- Make sure that a filter is always installed. Using the air conditioning system without a filter may cause damage to the system.
- The filter is replaceable. When cleaning the filter, do not clean with water or an air gun.

■ **To prevent damage to the filter cover**

When moving the filter cover in the direction of arrow to release the fitting, pay attention not to apply excessive force to the claws. Otherwise, the claws may be damaged.

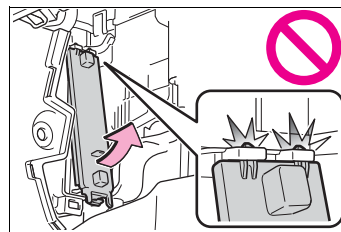

Electronic key battery

Replace the battery with a new one if it is depleted.

■ If the key battery is depleted

The following symptoms may occur:

- The smart key system and wireless remote control will not function properly.
- The operational range will be reduced.

Items to prepare

Prepare the following before replacing the battery:

- Flathead screwdriver
- Small flathead screwdriver
- Lithium battery CR2450

■ Use a CR2450 lithium battery

- Batteries can be purchased at your Toyota dealer, local electrical appliance shops or camera stores.
- Replace only with the same or equivalent type recommended by the manufacturer.
- Dispose of used batteries according to the local laws.

Replacing the battery

- 1 Release the lock and remove the mechanical key.

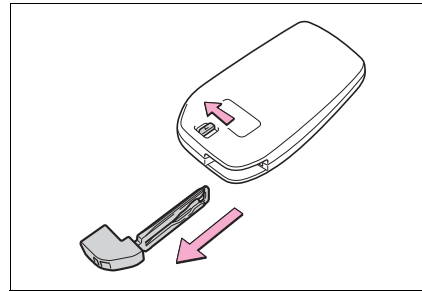

- 2 Remove the key cover.

Use a screwdriver of an appropriate size. Forcedly prying may cause the cover damaged.

To prevent damage to the key, cover the tip of the flathead screwdriver with a rag.

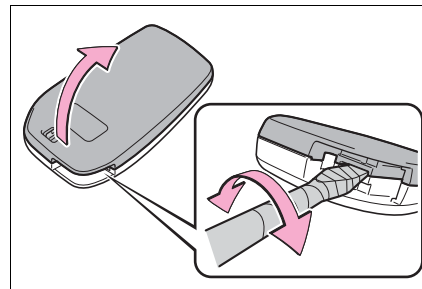

- 3 Remove the depleted battery using a small flathead screwdriver.

When removing the cover, the electronic key module may stick to the cover and the battery may not be visible.

In this case, remove the electronic key module in order to remove the battery.

When removing the battery, use a screwdriver of an appropriate size. Insert a new battery with the “+” ter-

terminal facing up.

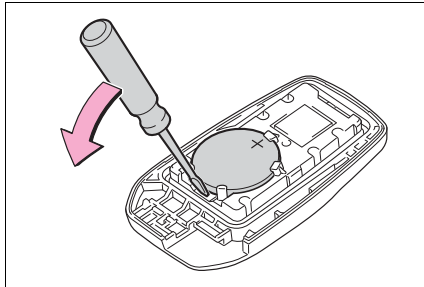

- 4 When installing the key cover and mechanical key, install by conducting step 2 and step 1 with the directions reversed.

⚠ WARNING

■ **Battery precautions**

Observe the following precautions.

Failure to do so may result in death or serious injury.

- Do not swallow the battery. Doing so may cause chemical burns.
- A coin battery or button battery is used in the electronic key. If a battery is swallowed, it may cause severe chemical burns in as little as 2 hours and may result in death or serious injury.
- Keep away new and removed batteries from children.
- If the cover cannot be firmly closed, stop using the electronic key and stow the key in the place where children cannot reach, and then contact your Toyota dealer.

- If you accidentally swallow a battery or put a battery into a part of your body, get emergency medical attention immediately.

■ **To prevent battery explosion or leakage of flammable liquid or gas**

- Replace the battery with a new battery of the same type. If a wrong type of battery is used, it may explode.
- Do not expose batteries to extremely low pressure due to high altitude or extremely high temperatures.
- Do not burn, break or cut a battery.

⚠ NOTICE

■ **When replacing the battery**

Use a flathead screwdriver of appropriate size. Applying excessive force may deform or damage the cover.

■ **For normal operation after replacing the battery**

Observe the following precautions to prevent accidents:

- Always work with dry hands. Moisture may cause the battery to rust.
- Do not touch or move any other component inside the remote control.
- Do not bend either of the battery terminals.

Checking and replacing fuses

If any of the electrical components do not operate, a fuse may have blown. If this happens, check and replace the fuses as necessary.

Checking and replacing fuses

- 1 Turn the power switch off.
Confirm that the charging connector is not connected. Also, do not use the Remote Air Conditioning System during the procedure.
- 2 Open the fuse box cover.
 - ▶ Motor compartment
Push the tab in and lift the lid off.

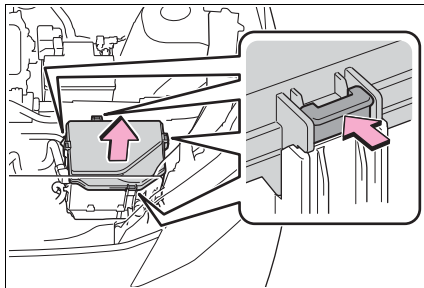

- ▶ Left side instrument panel
Remove the lid.

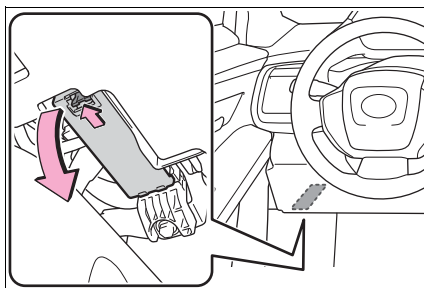

- 3 Remove the fuse.

Only type A fuse can be removed using the pullout tool.

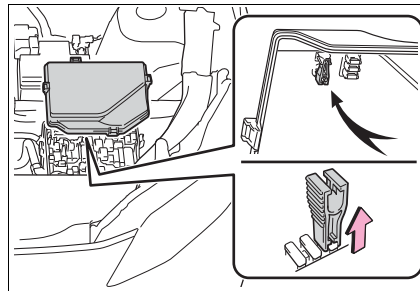

- 4 Check if the fuse is blown.

Replace the blown fuse with a new fuse of an appropriate amperage rating. The amperage rating can be found on the fuse box lid.

- ▶ Type A

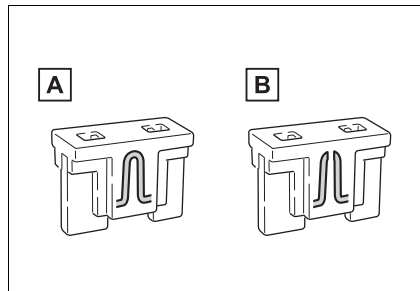

- A** Normal fuse
- B** Blown fuse

- ▶ Type B

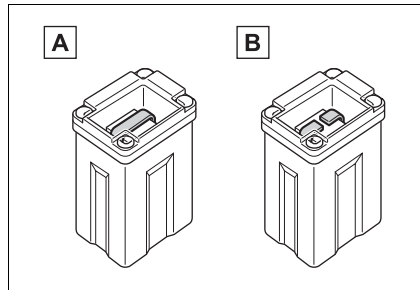

- A** Normal fuse

B Blown fuse

► Type C

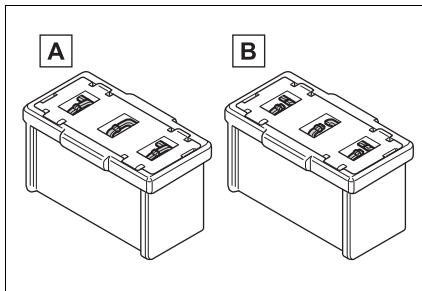

A Normal fuse

B Blown fuse

■ **After a fuse is replaced**

- When installing the lid, make sure that the tab is installed securely.
- If the lights do not turn on even after the fuse has been replaced, a bulb may need replacement.
- If the replaced fuse blows again, have the vehicle inspected by a Toyota dealer.

■ **If there is an overload in a circuit**

The fuses are designed to blow, protecting the wiring harness from damage.

■ **When replacing an electronic component, such as a light, etc.**

Toyota recommends that you use genuine Toyota products designed for this vehicle. Because certain bulbs are connected to circuits designed to prevent overload, non-genuine parts or parts not designed for this vehicle may be unusable.

⚠ WARNING

■ **To prevent system breakdowns and vehicle fire**

Observe the following precautions. Failure to do so may cause damage to the vehicle, and possibly a fire or injury.

- Never use a fuse of a higher amperage rating than that indicated, or use any other object in place of a fuse.
- Always use a genuine Toyota fuse or equivalent. Never replace a fuse with a wire, even as a temporary fix.
- Do not modify the fuses or fuse boxes.

⚠ NOTICE

■ **Before replacing fuses**

Have the cause of electrical overload determined and repaired by a Toyota dealer as soon as possible.

Headlight aim

Vertical movement adjusting bolts

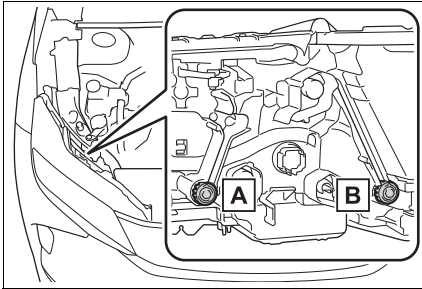

A Adjustment bolt A

B Adjustment bolt B

Before checking the headlight aim

- Make sure the vehicle has a full tank of gasoline and the area around the headlight is not deformed.
- Park the vehicle on level ground.
- Make sure the tire inflation pressure is at the specified level.
- Have someone sit in the driver's seat.
- Bounce the vehicle several times.

Adjusting the headlight aim

- 1 Using a Phillips-head screwdriver, turn bolt A in either direction.
Remember the turning direction and the number of turns.

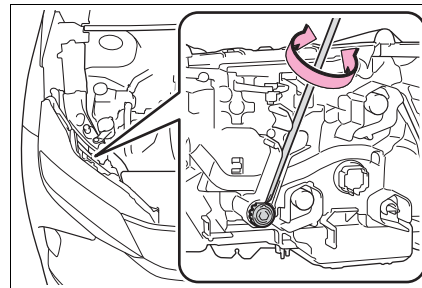

- 2 Turn bolt B the same number of turns and in the same direction as step 1.

If the headlight cannot be adjusted using this procedure, take the vehicle to your Toyota dealer to adjust the headlight aim.

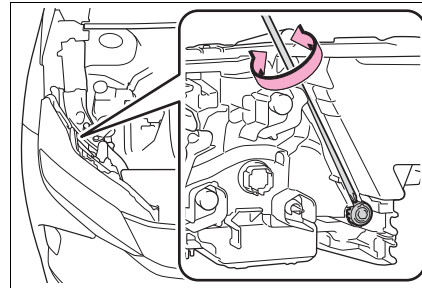

Light bulbs

If any exterior light does not turn on, have it replaced by your Toyota dealer.

■ LED lights

The lights consist of a number of LEDs. If any of the LEDs burn out, take your vehicle to your Toyota dealer to have the light replaced.

■ Condensation build-up on the inside of the lens

Temporary condensation build-up on the inside of the headlight lens does not indicate a malfunction. Contact your Toyota dealer for more information in the following situations:

- Large drops of water have built up on the inside of the lens.
- Water has built up inside the headlight.

■ When replacing an electronic component, such as a lights, etc.

→P.500

When trouble arises**8****8-1. Essential information**

Emergency flashers 504

If your vehicle has to be stopped in an emergency 505

If the vehicle is submerged or water on the road is rising 506

8-2. Steps to take in an emergency

If your vehicle needs to be towed..... 507

If you think something is wrong 511

If a warning light turns on or a warning buzzer sounds 513

If a warning message is displayed..... 522

If you have a flat tire.... 527

If the EV system will not start 537

If you lose your keys ... 539

If the electronic key does not operate properly .. 539

If the 12-volt battery is discharged 541

If your vehicle overheats 545

If the vehicle becomes stuck 547

Emergency flashers

sion.)

The emergency flashers are used to warn other drivers when the vehicle has to be stopped in the road due to a breakdown, etc.

Operating instructions

Press the switch.

All the turn signal lights will flash.

To turn them off, press the switch once again.

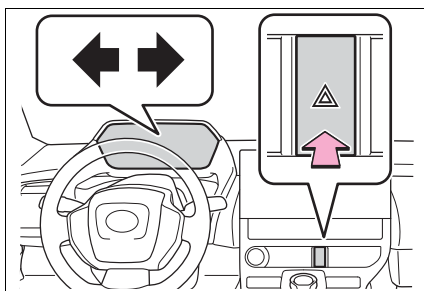

■ Emergency flashers

- If the emergency flashers are used for a long time while the EV system is not operating (while the "READY" indicator is not illuminated), the 12-volt battery may discharge.
- If any of the SRS airbags deploy (inflate) or in the event of a strong rear impact, the emergency flashers will turn on automatically. The emergency flashers will turn off automatically after operating for approximately 20 minutes. To manually turn the emergency flashers off, press the switch twice. (The emergency flashers may not turn on automatically depending on the force of the impact and conditions of the colli-

If your vehicle has to be stopped in an emergency

Only in an emergency, such as if it becomes impossible to stop the vehicle in the normal way, stop the vehicle using the following procedure:

Stopping the vehicle

- 1 Steadily step on the brake pedal with both feet and firmly depress it.
Do not pump the brake pedal repeatedly as this will increase the effort required to slow the vehicle.
- 2 Shift the shift position to N.
 - ▶ If the shift position is shifted to N
- 3 After slowing down, stop the vehicle in a safe place by the road.
- 4 Stop the EV system.
 - ▶ If the shift position cannot be shifted to N
- 3 Keep depressing the brake pedal with both feet to reduce vehicle speed as much as possible.
- 4 To stop the EV system: Press and hold the power switch for 2 consecutive seconds or

more, or press it briefly 3 times or more in succession.

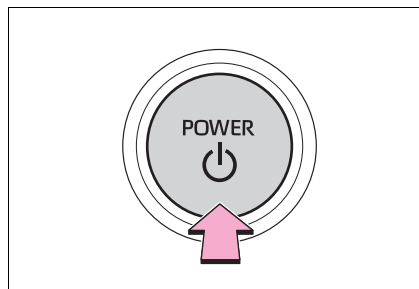

- 5 Stop the vehicle in a safe place by the road.

■ If emergency stopped

The functions of the air conditioning, etc., may be partially limited in order to reduce the power consumption of the 12-volt battery.

WARNING

■ If the EV system has to be turned off while driving

Turning the EV system off while driving will not cause a loss of steering or braking control. However, power assist for the steering wheel may be lost making it difficult to steer smoothly before stopping the vehicle depending on the remaining charge in the 12-volt battery or usage conditions. Decelerate as much as possible before turning off the EV system.

If the vehicle is submerged or water on the road is rising

This vehicle is not designed to be able to drive on roads that are deeply flooded with water. Do not drive on roads where the roads may be submerged or the water may be rising. It is dangerous to remain in the vehicle, if it anticipated that the vehicle will be flooded or set a drift. Remain calm and follow the following.

- If the door can be opened, open the door and exit the vehicle.
- If the door can not be opened, open the window using the power window switch and ensure an escape route.
- If the window can be opened, exit the vehicle through the window.
- If the door and window cannot be opened due to the rising water, remain calm, wait until the water level inside the vehicle rises to the point that the water pressure inside of the vehicle equals the water pressure outside of the vehicle and then open the door after waiting for the rising water to enter the vehicle, and exit the vehicle. When the

outside water level exceeds half the height of the door, the door cannot be opened from the inside due to water pressure.

■ **Water level exceeds the floor**

When the water level exceeds the floor and time has passed, the electrical equipment will get damaged, the power windows will not operate, the motor stop, and the vehicle may not be able to get moving.

■ **Using an emergency escape hammer***

Laminated glass is used in the windshield on this vehicle.

Laminated glass cannot be shattered with an emergency hammer*.

Tempered glass is used in the windows on this vehicle.

*: Contact your Toyota dealer or aftermarket accessory manufacturer for further information about an emergency hammer.

 **WARNING**

■ **Caution while driving**

Do not drive on roads where the roads may be submerged or the water may be rising. Otherwise the vehicle may be damaged and cannot move, as well as become flooded and set a drift, which may lead to death.

If your vehicle needs to be towed

If towing is necessary, we recommend having your vehicle towed by your Toyota dealer or commercial towing service, using a wheel-lift type truck or flat-bed truck.

Use a safety chain system for all towing, and abide by all state/provincial and local laws.

Situations when it is not possible to be towed by another vehicle

In the following situations, it is not possible to be towed by another vehicle using cables or chains, as the front wheels may be locked due to the parking lock. Contact your Toyota dealer or commercial towing service.

- There is a malfunction in the shift control system. (→P.233, 525)
- There is a malfunction in the immobilizer system. (→P.68)
- There is a malfunction in the smart key system. (→P.539)
- The 12-volt battery is discharged. (→P.541)

Situations when it is necessary to contact dealers before towing

The following may indicate a problem with your transmission. Contact your Toyota dealer or commercial towing service before towing.

- The EV system warning message is shown on the multi-information display and the vehicle does not move.
- The vehicle makes an abnormal sound.

Towing with a wheel-lift type truck

- ▶ From the front (2WD models)

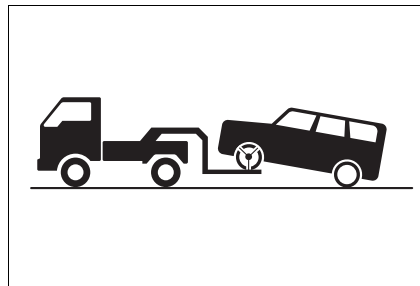

Release the parking brake.

Turn automatic mode off. (→P.244)

508 8-2. Steps to take in an emergency

- ▶ From the front (AWD models)

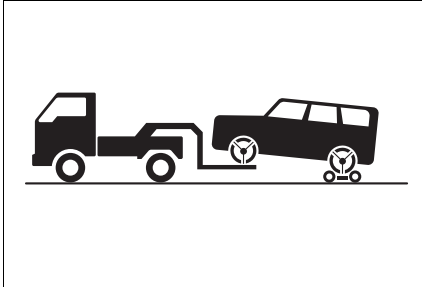

Use a towing dolly under the rear wheels.

- ▶ From the rear

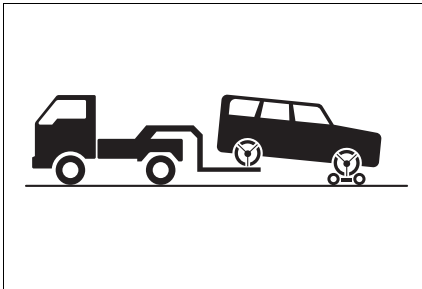

Use a towing dolly under the front wheels.

⚠ WARNING

Observe the following precautions. Failure to do so may result in death or serious injury.

■ When towing the vehicle

- ▶ 2WD models

Be sure to transport the vehicle with the front wheels raised or with all four wheels raised off the ground. If the vehicle is towed with the front wheels contacting the ground, the drivetrain and related parts may be damaged or electricity generated by the operation of the motor may cause a fire to occur depending on the nature of the damage or malfunction.

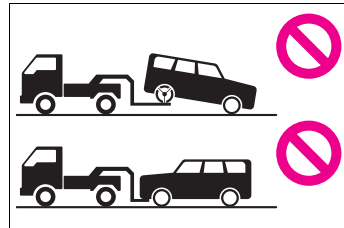

⚠ WARNING

► AWD models

Be sure to transport the vehicle with all four wheels raised off the ground. If the vehicle is towed with the tires contacting the ground, the drivetrain or related parts may be damaged, the vehicle may fly off the truck, or electricity generated by the operation of the motor may cause a fire to occur depending on the nature of the damage or malfunction.

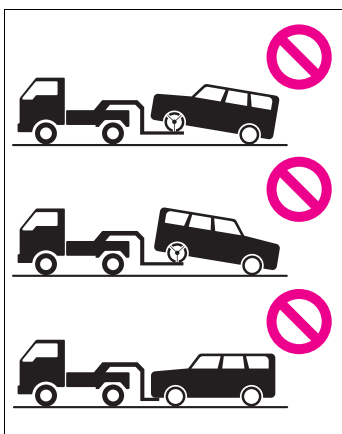

⚠ NOTICE

■ **To prevent damage to the vehicle when towing using a wheel-lift type truck**

When raising the vehicle, ensure adequate ground clearance for towing at the opposite end of the raised vehicle. Without adequate clearance, the vehicle could be damaged while being towed.

■ **Towing with a sling-type truck**

Do not tow with a sling-type truck to prevent body damage.

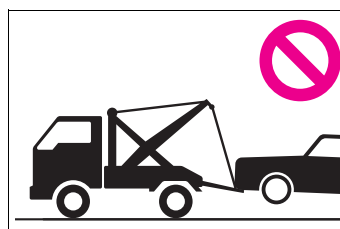

Using a flatbed truck

When using a flat-bed truck to transport the vehicle, use tire strapping belts. Refer to the owner's manual of the flat-bed truck for the tire strapping method.

In order to suppress vehicle movement during transportation, set the parking brake and turn the power switch off.

Emergency towing

If a tow truck is not available in an emergency, your vehicle may be temporarily towed using cables or chains secured to the emergency towing eyelets. This should only be attempted on hard surfaced roads for short distances at under 18 mph (30 km/h).

A driver must be in the vehicle to steer and operate the brakes. The vehicle's wheels, drive train, axles, steering and brakes must be in good condition.

Emergency towing procedure

To have your vehicle towed by another vehicle, the towing eyelet must be installed to your vehicle. Install the towing eyelet using the following procedure.

- 1 Take out the wheel bolt wrench and towing eyelet. (→P.486, 528)
- 2 Remove the eyelet cover using a flathead screwdriver.

To protect the bodywork, place a rag between the screwdriver and the vehicle body as shown in the illustration.

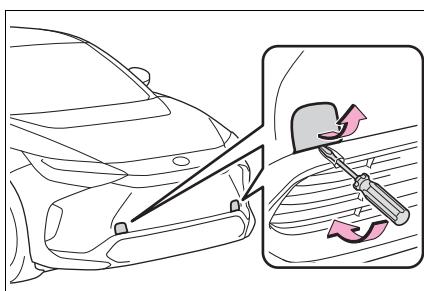

- 3 Insert the towing eyelet into the hole and tighten partially by hand.

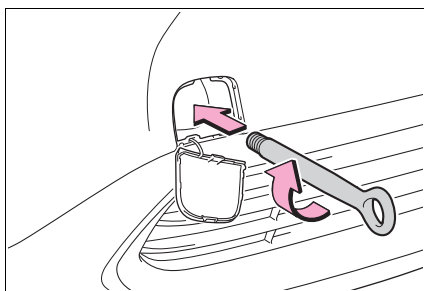

- 4 Tighten down the towing eyelet securely using a wheel

bolt wrench or hard metal bar.

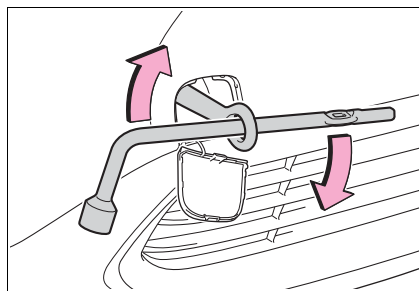

- 5 Securely attach cables or chains to the towing eyelet.

Take care not to damage the vehicle body.

- 6 Enter the vehicle being towed and start the EV system.

If the EV system does not start, turn the power switch to ON.

- 7 Shift the shift position to N and release the parking brake.

Turn automatic mode off. (→P.244)

While towing

If the EV system is off, the power assist for the brakes and steering will not function, making steering and braking more difficult.

Wheel bolt wrench

Wheel bolt wrench is installed in luggage compartment. (→P.486, 528)

WARNING

Observe the following precautions. Failure to do so may result in death or serious injury.

⚠ WARNING**■ While towing**

- When towing using cables or chains, avoid sudden starts, etc., which place excessive stress on the towing eyelets, cables or chains. The towing eyelets, cables or chains may become damaged, broken debris may hit people, and cause serious damage.
- Do not perform any of the following as doing so may cause the parking lock mechanism to engage, locking the front wheels and possibly leading to an accident resulting in death or serious injury:
 - Unfasten the driver's seat belt and open the driver's door.
 - Turn the power switch off.

■ Installing towing eyelets to the vehicle

Make sure that towing eyelets are installed securely. If not securely installed, towing eyelets may come loose during towing.

⚠ NOTICE**■ To prevent damage to the vehicle during emergency towing**

Do not secure cables or chains to the suspension components.

If you think something is wrong

If you notice any of the following symptoms, your vehicle probably needs adjustment or repair. Contact your Toyota dealer as soon as possible.

Visible symptoms

- Fluid leaks under the vehicle (Water dripping from the air conditioning after use is normal.)
- Flat-looking tires or uneven tire wear

Audible symptoms

- Excessive tire squeal when cornering
- Strange noises related to the suspension system
- Other noises related to the EV system

Operational symptoms

- Stumbling or running roughly
- Appreciable loss of power
- Vehicle pulls heavily to one side when braking
- Vehicle pulls heavily to one side when driving on a level road
- Loss of brake effectiveness,

512 **8-2. Steps to take in an emergency**

spongy feeling, pedal almost
touches the floor

If a warning light turns on or a warning buzzer sounds

Calmly perform the following actions if any of the warning lights comes on or flashes. If a light comes on or flashes, but then goes off, this does not necessarily indicate a malfunction in the system. However, if this continues to occur, have the vehicle inspected by your Toyota dealer.

Actions to the warning lights or warning buzzers

■ **Brake system warning light (warning buzzer)**

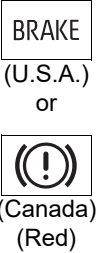
| Warning light | Details/Actions |
|--|--|
|  <p>BRAKE (U.S.A.) or (Canada) (Red)</p> | <p>Indicates that:</p> <ul style="list-style-type: none"> ● The brake fluid level is low; or ● The brake system is malfunctioning <p>→ Immediately stop the vehicle in a safe place and contact your Toyota dealer. Continuing to drive the vehicle may be dangerous.</p> |

■ **Brake system warning light**

| Warning light | Details/Actions |
|---|---|
|  <p>(Yellow)</p> | <p>Indicates a malfunction in:</p> <ul style="list-style-type: none"> ● The regenerative braking system; ● The electronically controlled brake system; or ● The parking brake system <p>→ Have the vehicle inspected by your Toyota dealer immediately.</p> |

■ **Charging system warning light***

| Warning light | Details/Actions |
|---|--|
|  | <p>Indicates a malfunction in the vehicle's charging system</p> <p>→ Immediately stop the vehicle in a safe place and contact your Toyota dealer.</p> |

*: This light illuminates on the multi-information display with a message.

■ SRS warning light (warning buzzer)

| Warning light | Details/Actions |
|---|---|
|  | <p>Indicates a malfunction in:</p> <ul style="list-style-type: none"> ● The SRS airbag system; or ● The seat belt pretensioner system <p>→ Have the vehicle inspected by your Toyota dealer immediately.</p> |

■ ABS warning light



| Warning light | Details/Actions |
|--|---|
|  | <p>Indicates a malfunction in:</p> <ul style="list-style-type: none"> ● The ABS; or ● The brake assist system <p>→ Have the vehicle inspected by your Toyota dealer immediately.</p> |

■ Inappropriate pedal operation warning light* (warning buzzer)

| Warning light | Details/Actions |
|---|---|
|  | <p>When a buzzer sounds:</p> <p>Indicates a malfunction in:</p> <ul style="list-style-type: none"> ● The Brake Override System; ● The Drive-Start Control <p>→ Have the vehicle inspected by your Toyota dealer immediately.</p> <p>Indicates that the shift position was changed and Drive-Start Control was operated while depressing the accelerator pedal.</p> <p>→ Momentarily release the accelerator pedal.</p> <p>When a buzzer does not sound:</p> <p>Indicates that the accelerator and brake pedals are being depressed simultaneously, and the Brake Override System is operating.</p> <p>→ Release the accelerator pedal and depress the brake pedal.</p> |

*: This light illuminates on the multi-information display with a message.

■ **Electric power steering system warning light (warning buzzer)**

| Warning light | Details/Actions |
|---|---|
|  (Red) or  (Yellow) | Indicates a malfunction in the EPS (Electric Power Steering) system → Have the vehicle inspected by your Toyota dealer immediately. |

■ **Traction battery charge warning light**

| Warning light | Details/Actions |
|--|---|
|  | Indicates that the remaining charge of the traction battery is low and charging is required When the outside temperature is low, this light may turn on earlier than usual to urge the driver to charge the traction battery early. → Charge the traction battery. (→P.98) |

■ **Driver's and front passenger's seat belt reminder light (warning buzzer*)**

| Warning light | Details/Actions |
|---|--|
|  | Warns the driver and/or front passenger to fasten their seat belts → Fasten the seat belt. If the front passenger's seat is occupied, the front passenger's seat belt also needs to be fastened to make the warning light (warning buzzer) turn off. |

* : Driver's and front passenger's seat belt warning buzzer:

The driver's and front passenger's seat belt warning buzzer sounds to alert the driver and front passenger that his or her seat belt is not fastened. If the seat belt is unfastened, the buzzer sounds intermittently for a certain period of time after the vehicle reaches a certain speed.

■ Rear passengers' seat belt reminder lights (warning buzzer)*

| Warning light | Details/Actions |
|---|--|
|  | Warns the rear passengers to fasten their seat belts → Fasten the seat belt. |

*: Rear passengers' seat belt warning buzzer:

The rear passengers' seat belt warning buzzer sounds to alert the rear passenger that his or her seat belt is not fastened. If the seat belt is unfastened, the buzzer sounds intermittently for a certain period of time after the vehicle reaches a certain speed.

■ Tire pressure warning light

| Warning light | Details/Actions |
|---|---|
|  | When the light comes on after blinking for approximately 1 minute (a buzzer does not sound): Malfunction in the tire pressure warning system → Have the system checked by your Toyota dealer. When the light comes on (a buzzer sounds): Low tire inflation pressure from natural causes → After the temperature of the tires has lowered sufficiently, check the inflation pressure of each tire and adjust them to the specified level. (→P.513) Low tire inflation pressure from flat tire → Immediately stop the vehicle in a safe place and perform the necessary actions (→P.519) |

■ LDA indicator (warning buzzer)

| Warning light | Details/Actions |
|---|--|
|  | Indicates a malfunction in the LDA (Lane Departure Alert). → Follow the instructions displayed on the multi-information display. |

■ LTA indicator (warning buzzer)

| Warning light | Details/Actions |
|---|--|
|  | Indicates a malfunction in the LTA (Lane Tracing Assist) → Follow the instructions displayed on the multi-information display. |

■ Driving assist information indicator

| Warning light | Details/Actions |
|---|---|
|  | <p>Indicates of the following systems is malfunctioning.</p> <ul style="list-style-type: none"> ● PCS (Pre-Collision System) ● LDA (Lane Departure Alert) <p>→ Follow the instructions displayed on the multi-information display.</p> <p>Indicates one of the following systems is malfunctioning or disabled.</p> <ul style="list-style-type: none"> ● PKSB (Parking Support Brake) (if equipped) ● RCD (Rear Camera Detection) (if equipped) ● BSM (Blind Spot Monitor) (if equipped) ● SEA (Safe Exit Assist) (if equipped) ● RCTA (Rear Cross Traffic Alert) (if equipped) <p>→ Follow the instructions displayed on the multi-information display.</p> |

■ Intuitive parking assist OFF indicator (warning buzzer)

| Warning light | Details/Actions |
|--|---|
|  <p>(Flashes) (if equipped)</p> | <p>Indicates a malfunction in the Intuitive parking assist function</p> <p>→ Have the vehicle inspected by your Toyota dealer immediately.</p> <p>Indicates that the system is temporarily unavailable, possibly due to a sensor being dirty or covered with ice, etc.</p> <p>→ Follow the instructions displayed on the multi-information display.</p> |

■ Cruise control indicator (warning buzzer)

| Warning light | Details/Actions |
|---|--|
|  <p>(Orange)</p> | <p>Indicates a malfunction in the cruise control system.</p> <p>→ Follow the instructions displayed on the multi-information display.</p> |

■ **Dynamic radar cruise control indicator (warning buzzer)**

| Warning light | Details/Actions |
|---|---|
|  (Orange) | Indicates a malfunction in the dynamic radar cruise control system. → Follow the instructions displayed on the multi-information display. |



■ **PCS warning light (warning buzzer)**

| Warning light | Details/Actions |
|---|--|
|  (Flashes or illuminates) | Indicates a malfunction in the PCS (Pre-Collision System). Follow the instructions displayed on the multi-information display. → Illuminates when the PCS (Pre-Collision System) or VSC (Vehicle Stability Control) system is disabled. |

■ **Slip indicator**

| Warning light | Details/Actions |
|---|---|
|  | Indicates a malfunction in: <ul style="list-style-type: none"> ● The VSC system; ● The TRAC system; or ● The hill-start assist control system → Have the vehicle inspected by your Toyota dealer immediately. |

■ **Parking brake indicator**

| Warning light | Details/Actions |
|--|--|
|  (U.S.A.) (Flashes) or  (Canada) (Flashes) | It is possible that the parking brake is not fully engaged or released → Operate the parking brake switch once again. This light comes on when the parking brake is not released. If the light turns off after the parking brake is fully released, the system is operating normally. |

■ Brake hold operated indicator

| Warning light | Details/Actions |
|---|--|
|  | Indicates a malfunction in the brake hold system → Have the vehicle inspected by your Toyota dealer immediately. |

■ Warning buzzer

In some cases, the buzzer may not be heard due to being in a noisy location or audio sound.

■ Front passenger detection sensor, seat belt reminder and warning buzzer

- If luggage is placed on the front passenger seat, the front passenger detection sensor may cause the warning light to flash and the warning buzzer to sound even if a passenger is not sitting in the seat.
- If a cushion is placed on the seat, the sensor may not detect a passenger, and the warning light may not operate properly.

■ SRS warning light

This warning light system monitors the airbag sensor assembly, front impact sensors, side impact sensors (front door), side impact sensors (front), side impact sensors (rear), driver's seat position sensor, driver's seat belt buckle switch, front passenger occupant classification system sensors, "AIR BAG ON" indicator light, "AIR BAG OFF" indicator light, front passenger's seat belt buckle switch, seat belt pretensioners, airbags, interconnecting wiring and power sources. (→P.44)

■ Electric power steering system warning light (warning buzzer)

When the 12-volt battery charge becomes insufficient or the voltage temporarily drops, the electric power steering system warning light may come on and the warning buzzer may sound.

■ When the tire pressure warning light comes on

Inspect the tires to check if a tire is punctured.

If a tire is punctured: →P.527

If none of the tires are punctured: Turn the power switch off then turn it to ON. Check if the tire pressure warning light comes on or blinks.

- ▶ If the tire pressure warning light blinks for approximately 1 minute then stays on

There may be a malfunction in the tire pressure warning system. Have the vehicle inspected by your Toyota dealer immediately.

- ▶ If the tire pressure warning light comes on
 - 1 After the temperature of the tires has lowered sufficiently, check the inflation pressure of each tire and adjust them to the specified level.
 - 2 If the warning light does not turn off even after several minutes have elapsed, check that the inflation pressure of each tire is at the specified level and perform the tire inflation pressure setting procedure. (→P.483)

If the warning light does not turn off even after several minutes have elapsed since performing the tire inflation pressure setting procedure, have the vehicle inspected by your Toyota dealer as soon as possible.

■ The tire pressure warning light may come on due to natural causes

The tire pressure warning light may

520 8-2. Steps to take in an emergency

come on due to natural causes such as natural air leaks and tire inflation pressure changes caused by temperature. In this case, adjusting the tire inflation pressure will turn off the warning light (after a few minutes).

■ Conditions that the tire pressure warning system may not function properly

→P.474

WARNING

■ If both the ABS and the brake system warning lights remain on

Stop your vehicle in a safe place immediately and contact your Toyota dealer.

The vehicle will become extremely unstable during braking, and the ABS system may fail, which could cause an accident resulting in death or serious injury.

■ When the electric power steering system warning light comes on

When the light comes on yellow, the assist to the power steering is restricted. When the light comes on red, the assist to the power steering is lost and handling operations of the steering wheel become extremely heavy.

When steering wheel operations are heavier than usual, grip the steering wheel firmly and operate it using more force than usual.

■ If the tire pressure warning light comes on

Be sure to observe the following precautions.

Failure to do so could cause a loss of vehicle control and result in death or serious injury.

- Stop your vehicle in a safe place as soon as possible. Adjust the tire inflation pressure immediately.

- If the tire pressure warning light comes on even after tire inflation pressure adjustment, it is probable that you have a flat tire. Check the tires. If a tire is flat, repair the flat tire by using emergency tire puncture repair kit.

- Avoid abrupt maneuvering and braking.
If the vehicle tires deteriorate, you could lose control of the steering wheel or the brakes.

■ If a blowout or sudden air leakage should occur

The tire pressure warning system may not activate immediately.

■ Maintenance of the tires

Each tire, including the spare (if provided), should be checked monthly when cold and inflated to the inflation pressure recommended by the vehicle manufacturer on the vehicle placard or tire inflation pressure label (tire and load information label). (If your vehicle has tires of a different size than the size indicated on the vehicle placard or tire inflation pressure label [tire and load information label], you should determine the proper tire inflation pressure for those tires.)

⚠ WARNING

As an added safety feature, your vehicle has been equipped with a tire pressure monitoring system (TPMS-tire pressure warning system) that illuminates a low tire pressure telltale (tire pressure warning light) when one or more of your tires is significantly under-inflated. Accordingly, when the low tire pressure telltale (tire pressure warning light) illuminates, you should stop and check your tires as soon as possible, and inflate them to the proper pressure. Driving on a significantly under-inflated tire causes the tire to overheat and can lead to tire failure. Under-inflation also reduces fuel efficiency and tire tread life, and may affect the vehicle's handling and stopping ability.

Please note that the TPMS (tire pressure warning system) is not a substitute for proper tire maintenance, and it is the driver's responsibility to maintain correct tire pressure, even if under-inflation has not reached the level to trigger illumination of the TPMS low tire pressure telltale (tire pressure warning light).

Your vehicle has also been equipped with a TPMS (tire pressure warning system) malfunction indicator to indicate when the system is not operating properly. The TPMS (tire pressure warning system) malfunction indicator is combined with the low tire pressure telltale (tire pressure warning light). When the system detects a malfunction, the telltale will flash for approximately one minute and then remain continuously illuminated. This sequence will continue upon subsequent vehicle start-ups as long as the malfunction exists. When the malfunction indicator is illuminated, the system may not be able to detect or signal low tire pressure as intended.

TPMS (tire pressure warning system) malfunctions may occur for a variety of reasons, including the installation of replacement or alternate tires or wheels on the vehicle that prevent the TPMS (tire pressure warning system) from functioning properly. Always check the TPMS (tire pressure warning system) malfunction telltale after replacing one or more tires or wheels on your vehicle to ensure that the replacement or alternate tires and wheels allow the TPMS (tire pressure warning system) to continue to function properly.

⚠ NOTICE

■ To ensure the tire pressure warning system operates properly

Do not install tires with different specifications or makers, as the tire pressure warning system may not operate properly.

If a warning message is displayed

The multi-information display shows warnings of system malfunctions, incorrectly performed operations, and messages that indicate a need for maintenance. When a message is shown, perform the correction procedure appropriate to the message.

If a warning message is displayed again after the appropriate actions have been performed, contact your Toyota dealer.

Additionally, if a warning light comes on or flashes at the same time that a warning message is displayed, take the appropriate corrective action for the warning light. (→P.513)

■ Warning messages

The warning messages explained below may differ from the actual messages according to operation conditions and vehicle specifications.

■ Warning buzzer

In some cases, the buzzer may not be heard due to being in a noisy location or audio sound.

■ If “EV system stopped Steering power low” is displayed

This message is displayed if the EV system is stopped while driving.

When steering wheel operations are heavier than usual, grip the steering wheel firmly and operate it using more force than usual.

■ If “EV system overheated Output power reduced” is displayed

This message may be displayed when driving under severe operating conditions. (For example, when driving up a long steep hill.)
Handling method: →P.545

■ If “Shift System Malfunction Shifting Unavailable Drive to a Safe Place and Stop” or “Shift System Malfunction Driving Unavailable” is displayed

There is a malfunction in the shift control system. Have the vehicle inspected by your Toyota dealer immediately.

■ If “Shift is in N Release accelerator before shifting” is displayed

The accelerator pedal has been depressed when the shift position is in N.

Release the accelerator pedal and shift the shift position to D or R.

■ If “Press brake when vehicle is stopped EV system may overheat” is displayed

The message may be displayed when the accelerator pedal is depressed to hold the vehicle while the vehicle is stopped on an incline, etc. The EV system may overheat. Release the accelerator pedal and depress the brake pedal.

■ If “Auto Power Off To Conserve Battery” is displayed

Power was turned off due to the automatic power off function. Next time when starting the EV system, operate the EV system for approximately 5 minutes to recharge the 12-volt battery.

■ **If “Regenerative Braking Limited Press Brake to Decelerate” is displayed**

Regenerative braking may be restricted in the following situations. Firmly depress the brake pedal to decelerate the vehicle.

- When electrical energy cannot be regenerated any more as the traction battery is fully charged
- When the temperature of the traction battery is extremely high or extremely low
- When the temperature of the electric motor or power control unit, etc., is extremely high

■ **If “High Power Consumption Power to Climate Temporarily Limited” is displayed**

Turn off unnecessary electronic equipment to reduce power consumption.

Please wait until the power supply returns to normal.

■ **If “Headlight System Malfunction Visit Your Dealer” is displayed**

The following systems may be malfunctioning. Have the vehicle inspected by your Toyota dealer immediately.

- The LED headlight system
- Automatic High Beam

■ **If “System Malfunction Visit Your Dealer” is displayed**

Indicates one of the following systems is disabled.

- PCS (Pre-Collision System)
- LDA (Lane Departure Alert)
- LTA (Lane Tracing Assist)
- AHB (Automatic High Beam)
- Dynamic radar cruise control
- RSA (Road Sign Assist)
- BSM (Blind Spot Monitor) (if equipped)

- RCTA (Rear Cross Traffic Alert) (if equipped)
- SEA (Safe Exit Assist) (if equipped)
- Intuitive parking assist (if equipped)
- PKSB (Parking Support Brake) (if equipped)
- RCD (Rear Camera Detection) (if equipped)

Have the vehicle inspected by your Toyota dealer immediately.

■ **If “System Stopped See Owner’s Manual” is displayed**

Indicates one of the following systems is disabled.

- PCS (Pre-Collision System)
- LDA (Lane Departure Alert)
- LTA (Lane Tracing Assist)
- AHB (Automatic High Beam)
- Dynamic radar cruise control
- RSA (Road Sign Assist)
- BSM (Blind Spot Monitor) (if equipped)
- RCTA (Rear Cross Traffic Alert) (if equipped)
- SEA (Safe Exit Assist) (if equipped)
- Intuitive parking assist (if equipped)
- PKSB (Parking Support Brake) (if equipped)
- RCD (Rear Camera Detection) (if equipped)

Follow the following correction methods.

- Check the voltage of the battery
- Remove any dirt or foreign matter from the front/rear side radar sensors

■ **If “System Stopped Front Camera Low Visibility See Owner’s Manual” is displayed**

Indicates one of the following systems is disabled.

- PCS (Pre-Collision System)
- LDA (Lane Departure Alert)
- LTA (Lane Tracing Assist)
- AHB (Automatic High Beam)
- Dynamic radar cruise control
- RSA (Road Sign Assist)

Follow the following correction methods.

- Follow the following correction methods.
- Using the windshield wipers, remove the dirt or foreign matter from the windshield.
- Using the air conditioning system, defog the windshield.

Close the hood, remove any stickers, etc. to clear the obstruction in front of the front camera.

■ **If “System Stopped Front Camera Out of Temperature Range Wait until Normal Temperature” is displayed**

Indicates one of the following systems is disabled.

- PCS (Pre-Collision System)
- LDA (Lane Departure Alert)
- LTA (Lane Tracing Assist)
- AHB (Automatic High Beam)
- Dynamic radar cruise control
- RSA (Road Sign Assist)

Follow the following correction methods.

- If the front camera is hot, such as after the vehicle is parked in the sun, use the air conditioning system to decrease the temperature around the front camera
- If a sunshade was used when the

vehicle was parked, depending on its type, the sunlight reflected from the surface of the sunshade may cause the temperature of the front camera to become excessively high

- If the front camera is cold, such as after the vehicle is parked in an extremely cold environment, use the air conditioning system to increase the temperature around the front camera

■ **If “System Stopped Front Radar Sensor Blocked Clean Radar Sensor” is displayed**

Indicates one of the following systems is disabled.

- PCS (Pre-Collision System)
- LDA (Lane Departure Alert)
- LTA (Lane Tracing Assist)
- AHB (Automatic High Beam)
- Dynamic radar cruise control
- RSA (Road Sign Assist)

Follow the following correction methods.

- Check if there is any foreign matter attached to the radar sensor or radar sensor cover and clean them if necessary (→P.261)
- This message may be displayed when driving in an open area with few nearby vehicles or structures, such as a desert, grasslands, suburbs, etc.

The message may be cleared by driving the vehicle in an area with structures, vehicles, etc., nearby.

■ **If “System Stopped Front Radar Sensor Out of Temperature Range Wait until Normal Temperature” is displayed**

Indicates one of the following systems is disabled.

- PCS (Pre-Collision System)
- LDA (Lane Departure Alert)
- LTA (Lane Tracing Assist)

- AHB (Automatic High Beam)
- Dynamic radar cruise control
- RSA (Road Sign Assist)

Follow the following correction methods.

- The temperature of the radar sensor is outside of the operating range. Wait for the temperature to become appropriate.

■ **If “System Stopped Front Radar In Self Calibration See Owner’s Manual” is displayed**

Indicates one of the following systems is disabled.

- PCS (Pre-Collision System)
- LDA (Lane Departure Alert)
- LTA (Lane Tracing Assist)
- AHB (Automatic High Beam)
- Dynamic radar cruise control
- RSA (Road Sign Assist)

Follow the following correction methods.

- Check if there is any foreign matter attached to the radar sensor or radar sensor cover and clean them if necessary (→P.261)
- The radar sensor may be misaligned and will be adjusted automatically while driving. Continue driving for a while.

■ **If “Cruise Control Unavailable See Owner’s Manual” is displayed**

Indicates one of the following systems is disabled.

- Dynamic radar cruise control
- Cruise control

A message is displayed when the driving assist switch is pushed repeatedly.

Press the driving assist switch quickly and firmly.

■ **If a message that indicates the need for visiting your Toyota dealer is displayed**

The system or part shown on the multi-information display is malfunctioning. Have the vehicle inspected by your Toyota dealer immediately.

■ **If a message that indicates the need for the rotary shifter operation is displayed**

To prevent the rotary shifter from being operated incorrectly or the vehicle from moving unexpectedly, a message that requires shifting the shift position may be displayed on the multi-information display. In that case, follow the instruction of the message and shift the shift position.

■ **If a message that indicates the need for referring to Owner’s Manual is displayed**

- If any of the following messages are shown on the multi-information display, follow the instructions.
 - “Battery Low” (→P.541)
 - “Check Charging System Close Charging Port Lid” (→P.140)
 - “Charging system malfunction” (→P.140)
 - “Charging stopped High energy use” (→P.140)
- If any of the following messages are shown on the multi-information display, it may indicate a malfunction. Have the vehicle inspected by your Toyota dealer immediately.
 - “Entry & Start System Malfunction”
 - “Traction battery system malfunction”
 - “Accelerator system malfunction”
 - “Plug-in Charging System Malfunction”
 - “EV system malfunction”
 - “Shift System Malfunction Apply Parking Brake Securely When Parking See Owner’s Manual”
 - “Shift System Malfunction See Owner’s Manual”
 - “Shift System Malfunction Stop in

526 8-2. Steps to take in an emergency

- a Safe Place See Owner's Manual"
- "P Switch Malfunction Apply Parking Brake Securely When Parking See Owner's Manual"
- "Shift System Unavailable Apply Parking Brake Securely When Parking See Owner's Manual"
- "Battery Low Shifting Unavailable See Owner's Manual"
- If any of the following messages are shown on the multi-information display, it may indicate a malfunction. Immediately stop the vehicle and contact your Toyota dealer.
- "Braking Power Low"

● If the EV system does not start, contact your Toyota dealer immediately.



NOTICE

■ If **"High Power Consumption Power to Climate Temporarily Limited"** is displayed frequently

There is a possible malfunction relating to the charging system or the 12-volt battery may be deteriorating. Have the vehicle inspected by your Toyota dealer.

■ If **"Battery Low"** is displayed frequently

The 12-volt battery may have deteriorated. As the battery may discharge in this state when left unattended, have the battery inspected by your Toyota dealer.

■ If **"Maintenance Req'd. For Traction Battery At Your Dealer"** is shown

The traction battery is scheduled to be inspected or replaced. Have the vehicle inspected by your Toyota dealer immediately.

- Continuing to drive the vehicle without having the traction battery inspected will cause the EV system not to start.

If you have a flat tire

Your vehicle is not equipped with a spare tire, but instead is equipped with an emergency tire puncture repair kit.

A puncture caused by a nail or screw passing through the tire tread can be repaired temporarily using the emergency tire puncture repair kit.

(The kit contains a bottle of sealant. The sealant can be used only once to temporarily repair one tire without removing the nail or screw from the tire.) Depending on the damage condition of the flat tire, it may not be able to be repaired with the emergency tire puncture repair kit.

After temporarily repairing the tire with the kit, have the tire repaired or replaced by your Toyota dealer.

⚠ WARNING**■ If you have a flat tire**

Do not continue driving with a flat tire.

Driving even a short distance with a flat tire can damage the tire and the wheel beyond repair, which could result in an accident.

Before repairing the vehicle

- Stop the vehicle in a safe place on a hard, flat surface.
- Set the parking brake.
- Shift the shift position to P.
- Stop the EV system.
- Turn on the emergency flashers.
- Check the degree of the tire damage.

A tire should only be repaired with the emergency tire puncture repair kit if the damage is caused by a nail or screw passing through the tire tread.

- Do not remove the nail or screw from the tire. Removing the object may widen the opening and make emergency repair with the repair kit impossible.
- To avoid sealant leakage, move the vehicle until the area of the puncture, if known, is positioned at the top of the tire.

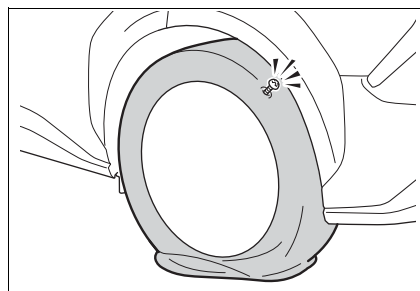
**■ A flat tire that cannot be repaired with the emergency tire puncture repair kit**

In the following cases, the tire cannot be repaired with the emergency

528 8-2. Steps to take in an emergency

tire puncture repair kit. Contact your Toyota dealer.

- When the tire is damaged due to driving without sufficient air pressure
- When there are any cracks or damage at any location on the tire, such as on the side wall, except the tread
- When the tire is visibly separated from the wheel
- When the cut or damage to the tread is 0.16 in. (4 mm) long or more
- When the wheel is damaged
- When two or more tires have been punctured
- When more than one sharp objects such as nails or screws have passed through the tread on a single tire

Location of the emergency tire puncture repair kit and tools

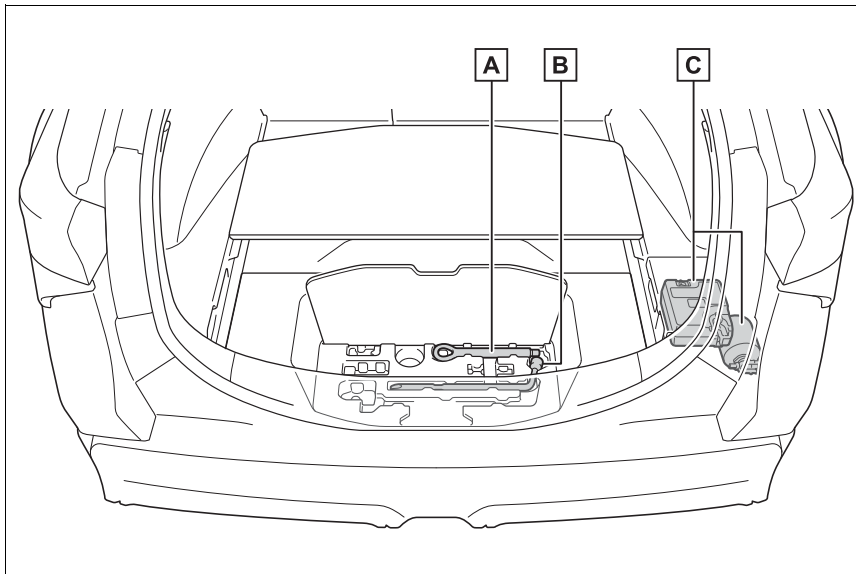

- A** Towing eyelet
- B** Wheel bolt wrench
- C** Emergency tire puncture repair kit

Emergency tire puncture repair kit components

■ Bottle

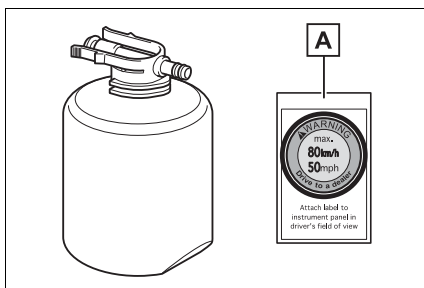

A Sticker

■ Compressor

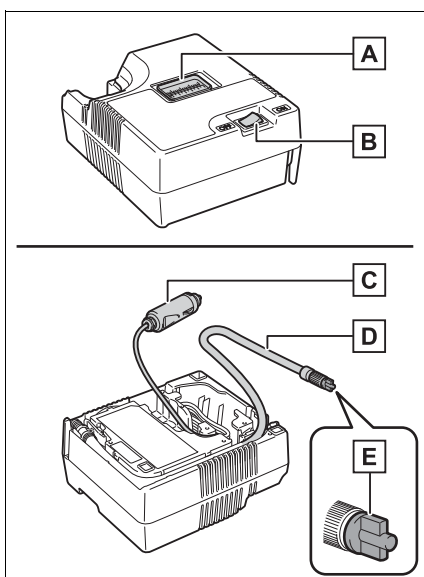

A Air pressure gauge

B Compressor switch

C Power plug

D Hose

E Air release cap

■ Emergency tire puncture repair kit

- The sealant stored in the emergency tire puncture repair kit can be used only once to temporarily repair a single tire. If the sealant in the bottle and other parts of the kit have been used and need to be replaced, contact your Toyota dealer.
 - The compressor can be used repeatedly.
 - The sealant can be used when the outside temperature is from -40°F (-40°C) to 140°F (60°C).
 - The kit is exclusively designed for size and type of tires originally installed on your vehicle. Do not use it for tires that a different size than the original ones, or for any other purposes.
 - If the sealant gets on your clothes, it may stain.
 - If the sealant adheres to a wheel or the surface of the vehicle body, the stain may not be removable if it is not cleaned at once. Immediately wipe away the sealant with a wet cloth.
 - During operation of the repair kit, a loud operation noise is produced. This does not indicate a malfunction.
 - Do not use to check or to adjust the tire pressure.
- Note for checking the emergency tire puncture repair kit**
- Check the sealant expiry date occasionally. The expiry date is shown on the bottle.
 - Do not use sealant whose expiry date has already passed. Otherwise, repairs conducted using the emergency tire puncture repair kit may not be performed properly.
 - The sealant has a limited life span. The expiry date is marked on the bottle. The sealant should

530 8-2. Steps to take in an emergency

be replaced before the expiry date. Contact your Toyota dealer for replacement.

WARNING

■ If you have a flat tire

Driving even a short distance with a flat tire can damage the tire and the wheel beyond repair.

Driving with a flat tire may cause a circumferential groove on the side wall. In such a case, the tire may explode when using a repair kit.

■ Caution while driving

- Store the repair kit in the luggage compartment. Injuries may result in the event of an accident or sudden braking.
- The repair kit is exclusively only for your vehicle. Do not use repair kit on other vehicles, which could lead to an accident causing death or serious injury.
- Do not use repair kit for tires that are different size than the original ones, or for any other purpose. If the tires have not been completely repaired, it could lead to an accident causing death or serious injury.

■ Precautions for use of the sealant

- Ingesting the sealant is hazardous to your health. If you ingest sealant, consume as much water as possible, then immediately consult a doctor.
- If sealant gets in eyes or adheres to skin, immediately wash it off with water. If discomfort persists, consult a doctor.

Taking out the emergency tire puncture repair kit

- 1 Open the deck board.

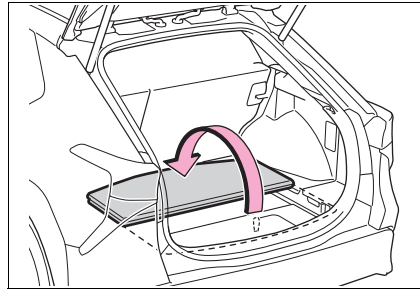

- 2 Remove the cover.

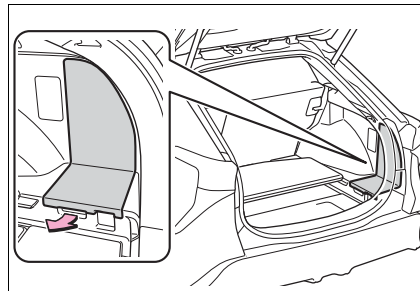

- 3 Take out the emergency tire puncture repair kit.

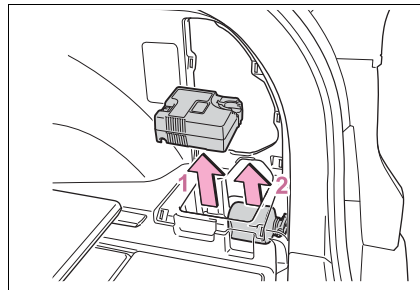

- 1 Compressor
- 2 Bottle

Emergency repair procedure

- 1 Take out the repair kit from the plastic bag.

Attach the sticker enclosed with the bottle on the specified locations. (See step 10.)

- 2 Remove the hose and take out the power plug from the compressor.

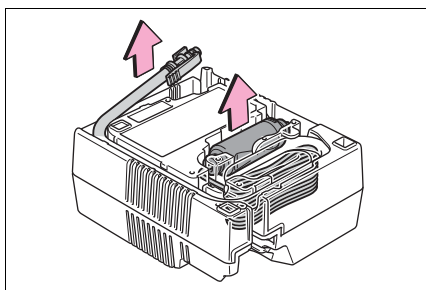

- 3 Connect the bottle to the compressor.

Insert and connect the bottle straight into the compressor as shown in the illustration, and check that the claws of the bottle are con-

cealed in the holes.

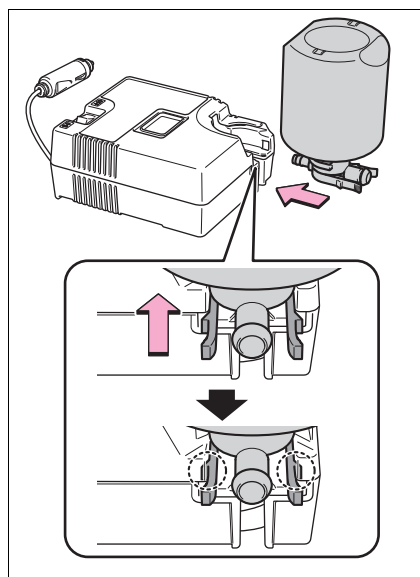

- 4 Connect the hose to the bottle.

As shown in the illustration, make sure the hose is connected securely to the bottle.

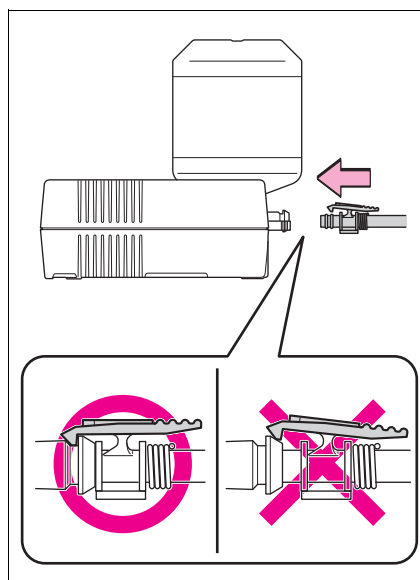

532 8-2. Steps to take in an emergency

- 5 Remove the valve cap from the valve of the punctured tire.

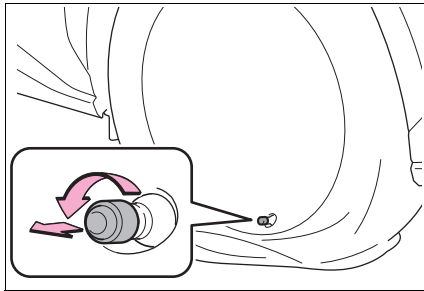

- 6 Extend the hose. Remove the air release cap from the hose.

You will use the air release cap again. Therefore keep it in a safe place.

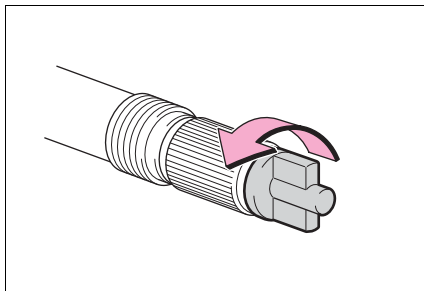

- 7 Connect the hose to the valve.

Screw the end of the hose clockwise as far as possible.

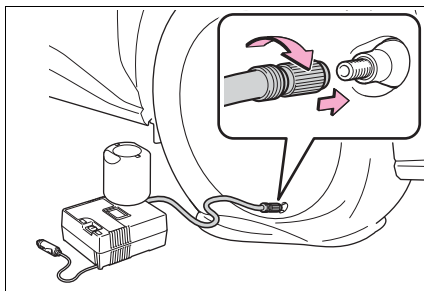

- 8 Make sure that the compressor switch is off.

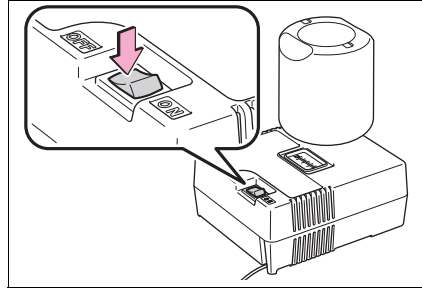

- 9 Connect the power plug to the power outlet socket. (→P.428)

- 10 Attach the sticker provided with the tire puncture repair kit to a position easily seen from the driver's seat.

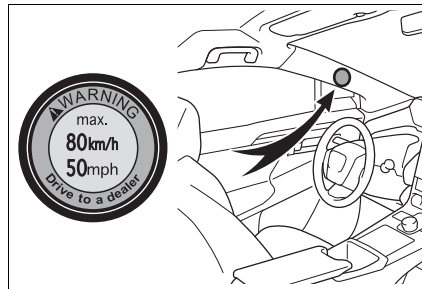

- 11 Check the specified tire inflation pressure.

Tire inflation pressure is specified on the label as shown. (→P.555)

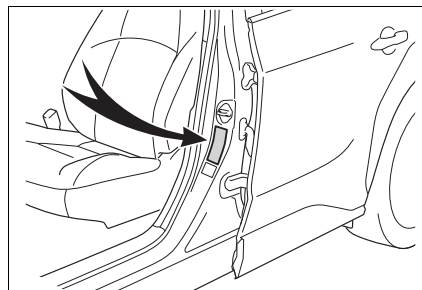

- 12 Start the EV system.
(→P.231)
- 13 To inject the sealant and inflate the tire, turn the compressor switch on.

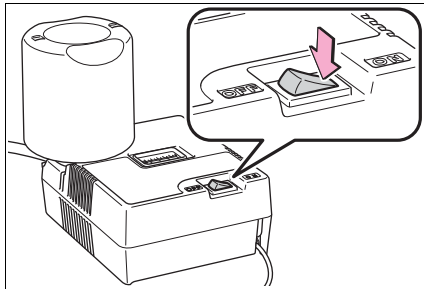

- 14 Inflate the tire until the recommended pressure is reached.

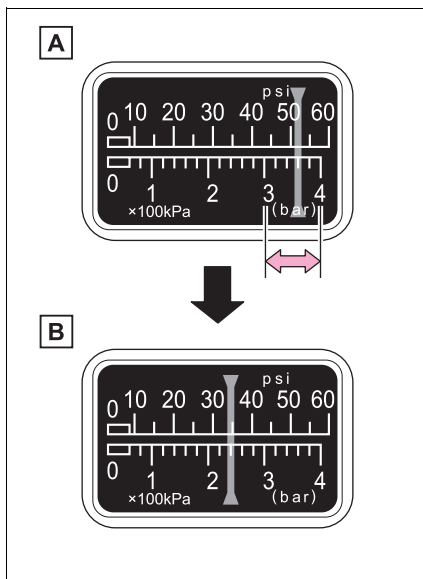

- A The sealant will be injected and the pressure will spike to between 44 psi (300 kPa, 3.0 kgf/cm² or bar) and 58 psi (400 kPa, 4.0 kgf/cm² or bar),

then gradually decrease.

- B The air pressure gauge will display the actual tire inflation pressure about 1 to 5 minutes after the switch is turned on.

- Turn the compressor switch off and then check the tire inflation pressure. Being careful not to over inflate, check and repeat the inflation procedure until the specified tire inflation pressure is reached.
- The tire can be inflated for about 5 to 20 minutes (depending on the outside temperature). If the tire inflation pressure is still lower than the specified point after inflation for 25 minutes, the tire is too damaged to be repaired. Turn the compressor switch off and contact your Toyota dealer.
- If the tire inflation pressure exceeds the specified air pressure, let out some air to adjust the tire inflation pressure. (→P.535)

- 15 With the compressor switch off, pull out the power plug from the power outlet socket and then disconnect the hose from the valve on the tire.

Some sealant may leak when the hose is removed.

- 16 Install the valve cap onto the valve of the emergency repaired tire.

- 17 Attach the air release cap to the end of the hose.

If the air release cap is not attached, the sealant may leak and

the vehicle may get dirty.

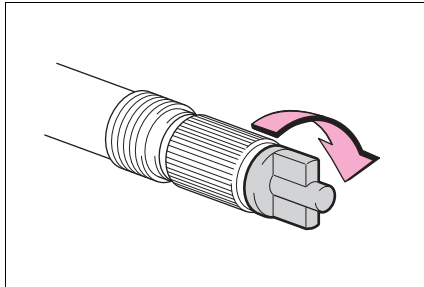

18 Temporarily store the bottle in the luggage compartment while it is connected to the compressor.

19 To spread the liquid sealant evenly within the tire, immediately drive safely for about 3 miles (5 km) below 50 mph (80 km/h).

20 After driving, stop your vehicle in a safe place on a hard, flat surface and reconnect the repair kit.

Remove the air release cap from the hose before reconnecting the hose.

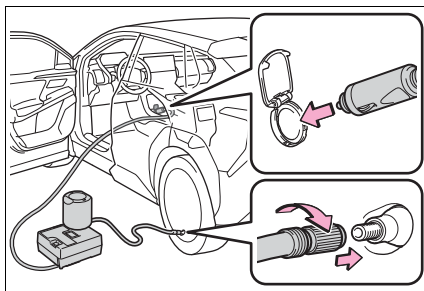

21 Turn the compressor switch on and wait for several seconds,

then turn it off. Check the tire inflation pressure.

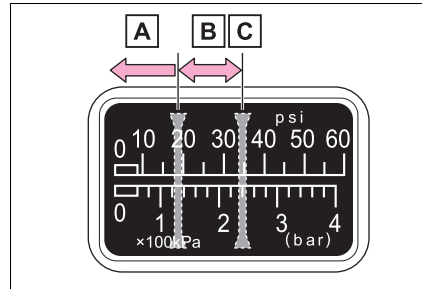

A If the tire inflation pressure is under 19 psi (130 kPa, 1.3 kgf/cm² or bar): The puncture cannot be repaired. Contact your Toyota dealer.

B If the tire inflation pressure is 19 psi (130 kPa, 1.3 kgf/cm² or bar) or higher, but less than the specified air pressure: Proceed to step 22.

C If the tire inflation pressure is the specified air pressure (→P.555): Proceed to step 23.

22 Turn the compressor switch on to inflate the tire until the specified air pressure is reached. Drive for about 3 miles (5 km) and then perform step 20.

23 Attach the air release cap to the end of the hose.

If the air release cap is not attached, the sealant may leak and

the vehicle may get dirty.

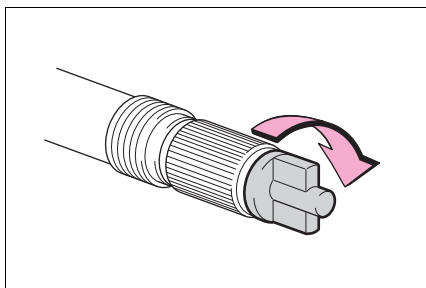

- 24** Store the bottle in the luggage compartment while it is connected to the compressor.
- 25** Taking precautions to avoid sudden braking, sudden acceleration and sharp turns, drive carefully at under 50 mph (80 km/h) to the nearest Toyota dealer that is less than 62 miles (100 km) away for tire repair or replacement.

For repair and replacement of a tire or disposal of the tire puncture repair kit, contact your Toyota dealer.

When having the tire repaired or replaced, make sure to tell the Toyota dealer that the sealant is injected.

■ **If the tire is inflated to more than the specified air pressure**

- 1** Disconnect the hose from the valve.
- 2** Install the air release cap to the end of the hose and push the protrusion on the air release cap into the valve to let some air out.

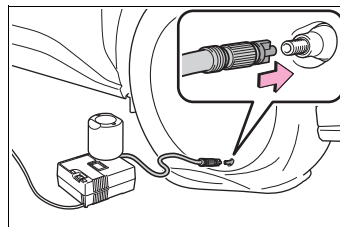

- 3** Disconnect the hose from the valve, remove the air release cap from the hose and then reconnect the hose.
- 4** Turn the compressor switch on and wait for several seconds, then turn it off. Check that the air pressure indicator shows the specified air pressure is reached. (→P.555)
If the air pressure is under the designated pressure, turn the compressor switch on again and repeat the inflation procedure until the specified air pressure is reached.

■ **After a tire is repaired with the emergency tire puncture repair kit**

- The tire pressure warning valve and transmitter should be replaced.
- Even if the tire inflation pressure is at the recommended level, the tire pressure warning light may come on/flash.

⚠ WARNING

■ **When fixing the flat tire**

- Stop your vehicle in a safe and flat area.
- Do not touch the wheels or the area around the brakes immediately after the vehicle has been driven. After the vehicle has been driven, the wheels and the area around the brakes may be extremely hot. Touching these areas with hands, feet or other body parts may result in burns.

 **WARNING**

- Connect the valve and hose securely with the tire installed on the vehicle.
If the hose is not properly connected to the valve, air leakage may occur as sealant may be sprayed out.
- If the hose comes off the valve while inflating the tire, there is a risk that the hose will move abruptly due to air pressure.
- After inflation of the tire has completed, the sealant may splatter when the hose is disconnected or some air is let out of the tire.
- Follow the operation procedure to repair the tire. If the procedure is not followed, the sealant may spray out.
- Keep back from the tire while it is being repaired, as there is a chance of it bursting while the repair operation is being performed. If you notice any cracks or deformation of the tire, turn off the compressor switch and stop the repair operation immediately.
- The repair kit may overheat if operated for a long period of time. Do not operate the compressor continuously for more than 40 minutes.
- Parts of the repair kit become hot during operation. Be careful handling the repair kit during and after operation. Do not touch the metal part connecting the bottle and the compressor. It will be extremely hot.

- Do not attach the vehicle speed warning sticker to an area other than the one indicated. If the sticker is attached to an area where an SRS airbag is located, such as the pad of the steering wheel, it may prevent the SRS air bag from operating properly.

■ **Driving to spread the liquid sealant evenly**

Observe the following precautions to reduce the risk of accidents.

Failing to do so may result in a loss of vehicle control and cause death or serious injury.

- Drive the vehicle carefully at a low speed. Be especially careful when turning and cornering.
- If the vehicle does not drive straight or you feel a pull through the steering wheel, stop the vehicle and check the following:
 - Tire condition. The tire may have separated from the wheel.
 - Tire inflation pressure. If the tire inflation pressure is 19 psi (130 kPa, 1.3 kgf/cm² or bar) or less, the tire may be severely damaged.

 **NOTICE**

■ **When performing an emergency repair**

- Perform the emergency repair without removing the nail or screw that has punctured the tread of the tire. If the object that has punctured the tire is removed, repair by the emergency tire puncture repair kit may not be possible.
- The repair kit is not waterproof. Make sure that the repair kit is not exposed to water, such as when it is being used in the rain.

 NOTICE

- Do not put the repair kit directly onto dusty ground such as sand at the side of the road. If the repair kit vacuums up dust, etc., a malfunction may occur.
 - Make sure the sealant bottle of the repair kit is in a vertical position. The repair kit does not operate properly when it is laid.
- **Precautions for the emergency tire puncture repair kit**
- The repair kit power source should be 12 V DC suitable for vehicle use. Do not connect the repair kit to any other source.
 - Place the repair kit in a storage to prevent it from being exposed to dirt or water.
 - Store the repair kit in the luggage compartment out of reach of children.
 - Do not disassemble or modify the repair kit. Do not subject parts such as the air pressure indicator to impacts. This may cause a malfunction.
- **To avoid damage to the tire pressure warning valves and transmitters**
- When a tire is repaired with liquid sealants, the tire pressure warning valve and transmitter may not operate properly. If a liquid sealant is used, contact your Toyota dealer or other qualified service shop as soon as possible. After use of liquid sealant, make sure to replace the tire pressure warning valve and transmitter when repairing or replacing the tire. (→P.476)

If the EV system will not start

Reasons for the EV system not starting vary depending on the situation. Check the following and perform the appropriate procedure:

The EV system will not start even though the correct starting procedure is being followed (→P.231)

One of the following may be the cause of the problem:

- The charging cable may be connected to the vehicle. (→P.102)
- The electronic key may not be functioning properly.* (→P.539)
- The traction battery may be completely discharged. Charge the traction battery. (→P.98)
- There may be a malfunction in the immobilizer system.* (→P.68)
- There may be a malfunction in the shift control system.* (→P.233, 525)
- The EV system may be malfunctioning due to an electrical problem such as electronic key battery depletion or a blown fuse. However,

depending on the type of malfunction, an interim measure is available to start the EV system. (→P.538)

- There is a possibility that the temperature of the traction battery is extremely low (approximately below -22°F [-30°C]). (→P.77, 232)

*: It may not be possible to shift the shift position from P

The interior lights and headlights are dim, or the horn does not sound or sounds at a low volume

One of the following may be the cause of the problem:

- The 12-volt battery may be discharged. (→P.541)
- The 12-volt battery terminal connections may be loose or corroded. (→P.468)

The interior lights and headlights do not turn on, or the horn does not sound

One of the following may be the cause of the problem:

- The 12-volt battery may be discharged. (→P.541)
- One or both of the 12-volt battery terminals may be disconnected. (→P.468)

Contact your Toyota dealer if the

problem cannot be repaired, or if repair procedures are unknown.

Starting the EV system in an emergency

When the EV system does not start, the following steps can be used as an interim measure to start the EV system if the power switch is functioning normally.

Do not use this starting procedure except in cases of emergency.

- 1 Set the parking brake.
- 2 Turn the power switch to ACC.*
- 3 Press and hold the power switch for about 15 seconds while depressing the brake pedal firmly.

After pressing the power switch for a while, a message regarding 12-volt battery control will be displayed, however continuing pressing the switch.

Even if the EV system can be started using the above steps, the system may be malfunctioning. Have the vehicle inspected by your Toyota dealer.

*: Setting can be customized. (→P.571)

If you lose your keys

New genuine keys can be made by your Toyota dealer using the other key and the key number stamped on your key number plate. Keep the plate in a safe place such as your wallet, not in the vehicle.

 NOTICE

■ **When an electronic key is lost**

If the electronic key remains lost, the risk of vehicle theft increases significantly. Visit your Toyota dealer immediately with all remaining electronic keys that were provided with your vehicle.

If the electronic key does not operate properly

If communication between the electronic key and vehicle is interrupted (→P.188) or the electronic key cannot be used because the battery is depleted, the smart key system and wireless remote control cannot be used. In such cases, the doors can be opened and the EV system can be started by following the procedure below.

■ **When the electronic key does not work properly**

- Make sure that the smart key system has not been deactivated in the customization setting. If it is off, turn the function on. (Customizable features: →P.569)
- Check if battery-saving mode is set. If it is set, cancel the function. (→P.188)

 NOTICE

■ **In case of a smart key system malfunction, or other key related problems**

Take your vehicle with all the electronic keys provided with your vehicle to your Toyota dealer.

Locking and unlocking the doors

Use the mechanical key (→P.164) in order to perform the following operations.

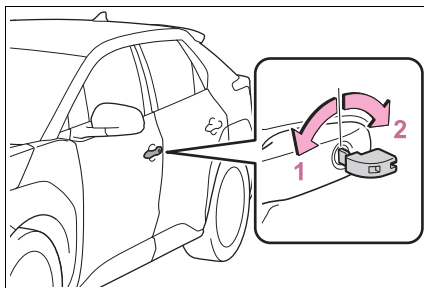

- 1 Locks all the doors
- 2 Unlocks the door

Turning the key rearward unlocks the driver's door. Turning the key once again within 5 seconds unlocks the other doors.

■ Key linked functions

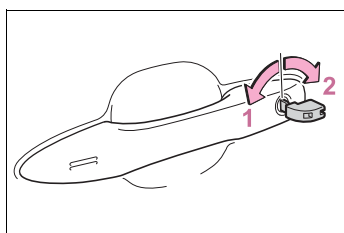

- 1 Closes the windows (turn and hold)*
- 2 Opens the windows (turn and hold)*

*: These settings must be customized at your Toyota dealer.

! WARNING

■ When using the mechanical key and operating the power windows

Operate the power window after checking to make sure that there is no possibility of any passenger having any of their body parts caught in the window. Also, do not allow children to operate the mechanical key. It is possible for children and other passengers to get caught in the power window.

Starting the EV system

- 1 Depress the brake pedal.
- 2 Touch the electronic key to the power switch.

When the electronic key is detected, a buzzer sounds and the power switch will turn to ON.

When the smart key system is deactivated in customization setting, the power switch will turn to ACC.

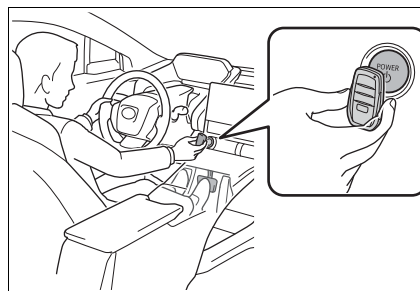

- 3 Firmly depress the brake pedal and check that  is displayed on the multi-information display.
- 4 Press the power switch shortly and firmly.

In the event that the EV system still

cannot be started, contact your Toyota dealer.

■ Stopping the EV system

Shift the shift position to P, set the parking brake and press the power switch as you normally do when stopping the EV system.

■ Replacing the key battery

As the above procedure is a temporary measure, it is recommended that the electronic key battery be replaced immediately when the battery is depleted. (→P.497)

■ Alarm

If a door is unlocked using the mechanical key when the alarm system is set, the alarm may be triggered. (→P.69)

■ Changing power switch modes

Release the brake pedal and press the power switch in step 3 above. The EV system does not start and modes will be changed each time the switch is pressed. (→P.234)

If the 12-volt battery is discharged

The following procedures may be used to start the EV system if the vehicle's 12-volt battery is discharged. You can also call your Toyota dealer or a qualified repair shop.

Restarting the EV system

If you have a set of jumper (or booster) cables and a second vehicle with a 12-volt battery, you can jump start your vehicle by following the steps below.

- 1 Confirm that the electronic key is being carried.

When connecting the jumper (or booster) cables, depending on the situation, the alarm may activate and the doors locked. (→P.70)

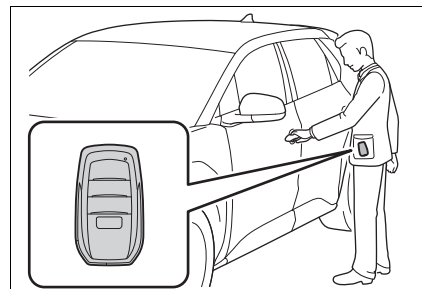

- 2 Open the hood (→P.462).
- 3 Open the positive (+) battery terminal cover.

While pressing on the claw, open the cover as shown in the illustra-

tion.

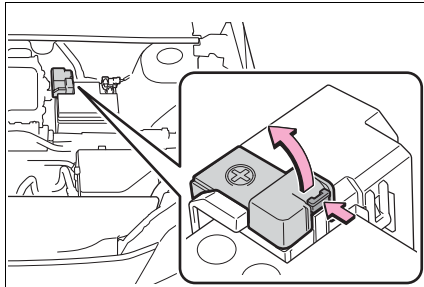

- 4 Connect a positive jumper cable clamp to **A** on your vehicle and connect the clamp on the other end of the positive cable to **B** on the second vehicle. Then, connect a negative cable clamp to **C** on the second vehicle and connect the clamp at the other end of the negative cable to **D**.

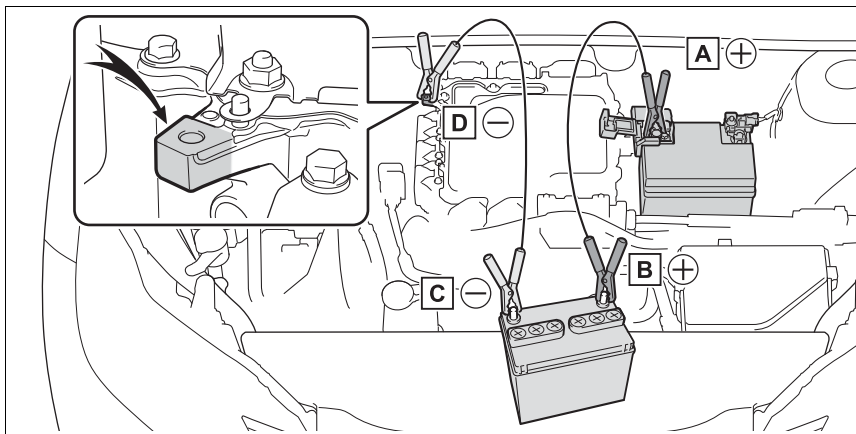

- A** Positive (+) battery terminal (your vehicle)
 - B** Positive (+) battery terminal (second vehicle)
 - C** Negative (-) battery terminal (second vehicle)
 - D** Solid, stationary, unpainted metallic point away from the battery and any moving parts as shown in the illustration
- 5 Start the engine of the second vehicle. Increase the engine speed slightly and maintain at that level for approximately 5 minutes to recharge the 12-volt battery of your vehicle.

- 6 Open and close any of the doors of your vehicle with the power switch OFF.
- 7 Maintain the engine speed of the second vehicle and start the EV system of your vehicle by turning the power switch to ON.
- 8 Make sure the “READY” indicator comes on. If the indicator light does not come on, contact your Toyota dealer.
- 9 Once the EV system has started, remove the jumper cables in the exact reverse order from which they were connected.
- 10 Close the positive (+) battery terminal cover.

Once the EV system starts, have the vehicle inspected at your Toyota dealer as soon as possible.

■ Starting the EV system when the 12-volt battery is discharged

The EV system cannot be started by push-starting.

■ To prevent 12-volt battery discharge

- Turn off the headlights, the air conditioning system, the audio system, etc. while the EV system is off.
- Turn off any unnecessary electrical components when the vehicle is running at a low speed for an extended period, such as in heavy traffic.

■ Charging the 12-volt battery

The electricity stored in the 12-volt battery will discharge gradually even when the vehicle is not in use, due to natural discharge and the draining effects of certain electrical appliances. If the vehicle is left for a long time, the 12-volt battery may discharge, and the EV system may be unable to start. (The 12-volt battery recharges automatically while the EV system is operating.)

■ When the 12-volt battery is removed or discharged

- Information stored in the ECU is cleared. When the 12-volt battery is depleted, have the vehicle inspected at your Toyota dealer.
- In some cases, it may not be possible to unlock the doors using the smart key system when the 12-volt battery is discharged. Use the wireless remote control or the mechanical key to lock or unlock the doors.
- The EV system may not start on the first attempt after the 12-volt battery has recharged but will start normally after the second attempt. This is not a malfunction.
- The power switch mode is memorized by the vehicle. When the 12-volt battery is reconnected, the system will return to the mode it was in before the 12-volt battery was discharged. Before disconnecting the 12-volt battery, turn the power switch off. If you are unsure what mode the power switch was in before the 12-volt battery discharged, be especially careful when reconnecting the 12-volt battery.
- If the 12-volt battery discharges, it may not be possible to shift the shift position to other positions. In this case, the vehicle cannot be towed without lifting both front wheels because the front wheels will be locked.
- The power back door (if equipped)

544 8-2. Steps to take in an emergency

must be initialized. (→P.181)

■ When replacing the 12-volt battery

- Use a 12-volt battery that conforms to European regulations.
- Use a 12-volt battery that the case size is same as the previous one (LN1), 20 hour rate capacity (20HR) is equivalent (45Ah) or greater, and performance rating (CCA) is equivalent (286A) or greater.
- If the sizes differ, the 12-volt battery cannot be properly secured.
- If an improper 12-volt battery is used, battery performance may decrease and the EV system may not be able to restart.
- If the 20 hour rate capacity is low, even if the time period where the vehicle is not used is a short time, the 12-volt battery may discharge and EV system may not be able to start.

For details, consult your Toyota dealer.



WARNING

■ When removing the 12-volt battery terminals

Always remove the negative (-) terminal first. If the positive (+) terminal contacts any metal in the surrounding area when the positive (+) terminal is removed, a spark may occur, leading to a fire in addition to electrical shocks and death or serious injury.

■ Avoiding 12-volt battery fires or explosions

Observe the following precautions to prevent accidentally igniting the flammable gas that may be emitted from the 12-volt battery:

- Make sure each jumper cable is connected to the correct terminal and that it is not unintentionally in contact with any other than the intended terminal.

- Do not allow the other end of the jumper cable connected to the "+" terminal to come into contact with any other parts or metal surfaces in the area, such as brackets or unpainted metal.

- Do not allow the + and - clamps of the jumper cables to come into contact with each other.

- Do not smoke, use matches, cigarette lighters or allow open flame near the 12-volt battery.

■ 12-volt battery precautions

The 12-volt battery contains poisonous and corrosive acidic electrolyte, while related parts contain lead and lead compounds.

Observe the following precautions when handling the 12-volt battery:

- When working with the 12-volt battery, always wear safety glasses and take care not to allow any battery fluids (acid) to come into contact with skin, clothing or the vehicle body.

- Do not lean over the 12-volt battery.

- In the event that battery fluid (acid) comes into contact with the skin or eyes, immediately wash the affected area with water and seek medical attention.

Place a wet sponge or cloth over the affected area until medical attention can be received.

- Always wash your hands after handling the 12-volt battery and other battery-related parts.

- Do not allow children near the 12-volt battery.

⚠ WARNING**■ When replacing the 12-volt battery**

- When the vent plug is close to the hold down clamp, the battery fluid (acid) may leak.
- For information regarding battery replacement, contact your Toyota dealer.

⚠ NOTICE**■ When handling jumper cables**

When connecting the jumper cables, ensure that they do not become entangled in the cooling fan.

If your vehicle overheats

When “EV System overheated Output power reduced” is shown on the multi-information display, your vehicle may be overheating.

⚠ NOTICE**■ Cooling system coolant**

The radiator coolant is exclusive for radiator usage. Damage may occur when water or any other type of coolant is used, so never use any other fluid. When there is no “Toyota Genuine Traction Battery Coolant”, immediately contact your Toyota dealer.

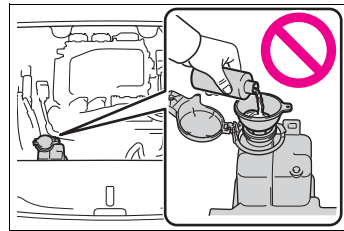
**Correction procedures**

- 1 Stop the vehicle in a safe place and turn off the air conditioning system.
- 2 Leave the EV system operating and carefully lift the hood.
- 3 Check if the cooling fan is operating.
If the fan is operating:
Wait until the “EV System overheated Output power reduced” message disap-

8

When trouble arises

546 8-2. Steps to take in an emergency

appears and then stop the EV system. If the message does not disappear, call your Toyota dealer.

If the fan is not operating: Stop the EV system immediately and call your Toyota dealer.

- 4 After the EV system has cooled down, inspect the hoses and radiator core (radiator) for any leaks.

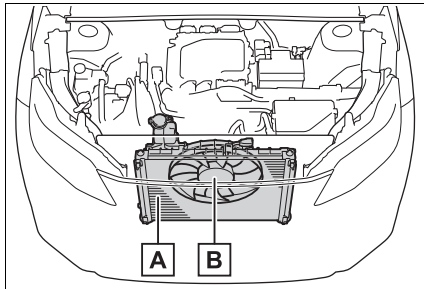

- A Radiator
- B Cooling fan

If a large amount of coolant leaks, immediately contact your Toyota dealer.

- 5 The coolant level is satisfactory if it is between the "MAX" and "MIN" lines on the reservoir.

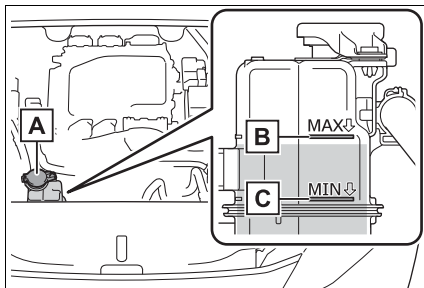

- A Reservoir
- B "MAX" line
- C "MIN" line

- 6 If the coolant is insufficient, replenish with "Toyota Genuine Traction Battery Coolant".

If you don't have "Toyota Genuine Traction Battery Coolant", contact your Toyota dealer.

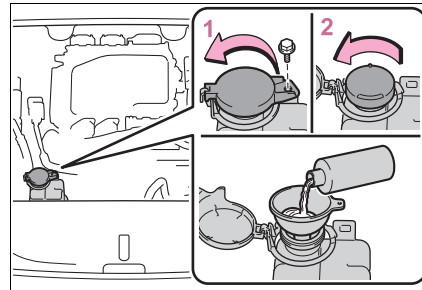

- 1 Remove the bolt.
- 2 Open the reservoir cap

Have the vehicle inspected at the nearest your Toyota dealer.

⚠ WARNING

- To prevent an accident or injury when inspecting under the hood of your vehicle

Observe the following precautions.

Failure to do so may result in serious injury such as burns.

- If steam is seen coming from under the hood, do not open the hood until the steam has subsided. The motor compartment may be very hot.

⚠ WARNING

- Keep hands and clothing (especially a tie, a scarf or a muffler) away from the fan. Failure to do so may cause the hands or clothing to be caught, resulting in serious injury.
- Do not loosen the coolant reservoir cap while the EV system and radiator are hot. High temperature steam or coolant could spray out.

⚠ NOTICE**■ When adding coolant**

Add coolant slowly after the EV system has cooled down sufficiently. Adding cool coolant to a hot EV system too quickly can cause damage to the EV system.

■ To prevent damage to the cooling system

Observe the following precautions:

- Avoid contaminating the coolant with foreign matter (such as sand or dust, etc.).
- Do not use water or any other coolant when refilling coolant. Also, do not use any additive agents for the coolant.

If the vehicle becomes stuck

Carry out the following procedures if the tires spin or the vehicle becomes stuck in mud, dirt or snow:

Recovering procedure

- 1 Stop the EV system. Set the parking brake and shift the shift position to P.
- 2 Remove the mud, snow or sand from around the stuck tire.
- 3 Place wood, stones or some other material under the front wheels to help provide traction.
- 4 Restart the EV system
- 5 Shift the shift position to D or R and release the parking brake. Then, while exercising caution, depress the accelerator pedal.

■ When it is difficult to free the vehicle

Press  to turn off TRAC.
(→P.388)

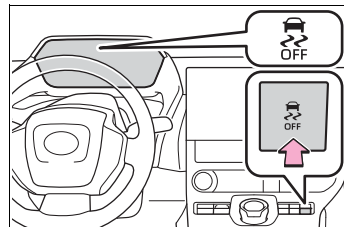

 **WARNING**

■ **When attempting to free a stuck vehicle**

If you choose to push the vehicle back and forth to free it, make sure the surrounding area is clear to avoid striking other vehicles, objects or people. The vehicle may also lunge forward or lunge back suddenly as it becomes free. Use extreme caution.

■ **When shifting the shift position**

Be careful not to shift the shift position with the accelerator pedal depressed.

This may lead to unexpected rapid acceleration of the vehicle that may cause an accident resulting in death or serious injury.

 **NOTICE**

■ **To avoid damaging the transmission and other components**

- Avoid spinning the tires and depressing the accelerator pedal more than necessary.
- If the vehicle remains stuck even after these procedures are performed, the vehicle may require towing to be freed.

Vehicle specifications

9

549

9-1. Specifications

Maintenance data 550

Tire information 556

9-2. Customization

Customizable features 566

9-3. Initialization

Items to initialize 577

9

Vehicle specifications

Maintenance data

Dimensions and weights

| | | |
|---|---------------------|--------------------|
| Overall length | 184.6 in. (4690 mm) | |
| Overall width | 73.2 in. (1860 mm) | |
| Overall height* | 65.0 in. (1650 mm) | |
| Wheelbase | 112.2 in. (2850 mm) | |
| Tread | Front | 63.0 in. (1600 mm) |
| | Rear | 63.4 in. (1610 mm) |
| Vehicle capacity weight (Occupants + luggage) | 1045 lb. (475 kg) | |

*: Unladen vehicle

Seating capacity

| | |
|------------------|---------------------|
| Seating capacity | 5 (Front 2, Rear 3) |
|------------------|---------------------|

Vehicle identification

■ Vehicle identification number

The vehicle identification number (VIN) is the legal identifier for your vehicle. This is the primary identification number for your Toyota. It is used in registering the ownership of your vehicle.

This number is on the top left of the instrument panel.

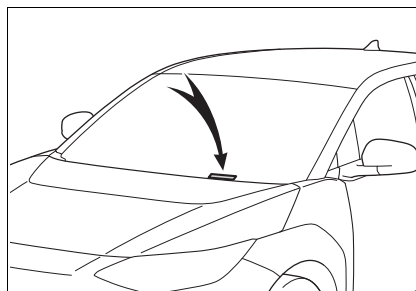

This number is also stamped under the right-hand front seat.

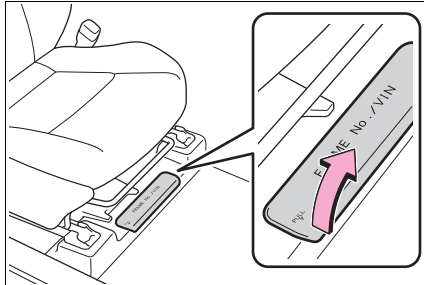

This number is also on the Certification Regulation Label.

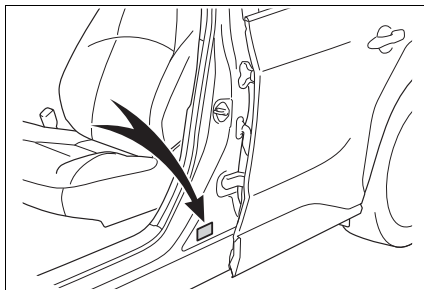

■ **Motor model type and motor number**

The motor model type and the motor number are stamped on

the motor as shown.

- ▶ Front electric motor (traction motor)

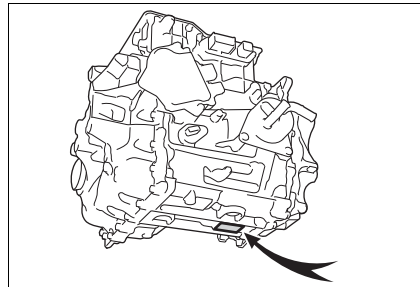

- ▶ Rear electric motor (traction motor) (AWD models)

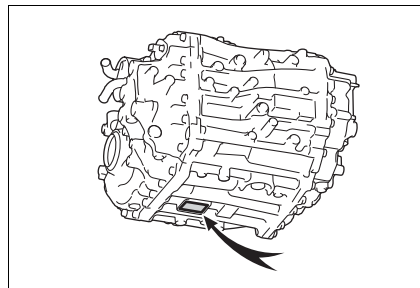

Front electric motor (traction motor)

| | | |
|----------------|------------------------------------|--------------------------------------|
| Model | 2WD | 1XM |
| | AWD | 1YM |
| Type | Permanent magnet synchronous motor | |
| Maximum output | 2WD | 150 kW |
| | AWD | 80 kW |
| Maximum torque | 2WD | 196.4 ft•lbf (266.3 N•m, 27.2 kgf•m) |
| | AWD | 124.3 ft•lbf (168.5 N•m, 17.2 kgf•m) |

Rear electric motor (traction motor) (AWD models)

| | |
|----------------|--------------------------------------|
| Model | 1YM |
| Type | Permanent magnet synchronous motor |
| Maximum output | 80 kW |
| Maximum torque | 124.3 ft•lbf (168.5 N•m, 17.2 kgf•m) |

Traction battery

| | |
|-----------------|--|
| Type | Lithium-ion battery |
| Voltage | 3.7 V/cell |
| Capacity | 201 Ah ^{*1} 205 Ah ^{*2} |
| Quantity | 96 cells |
| Nominal voltage | 355.2 V |

*1: 2WD models

*2: AWD models

Cooling system

| | |
|------------------------|--|
| Capacity ^{*1} | 6.2 qt. (5.9 L, 5.2 Imp. qt.) ^{*2} 7.8 qt. (7.4 L, 6.5 Imp. qt.) ^{*3} |
| Coolant type | Use either of the following: <ul style="list-style-type: none"> • “Toyota Genuine Traction Battery Coolant” • Similar high-quality ethylene glycol-based, low electric conductivity coolant, non-amine and non-borate coolant withazole additives. Do not use plain water alone. |

*1: The coolant capacity is the quantity of reference.
If replacement is necessary, contact your Toyota dealer.

*2: 2WD models

*3: AWD models

 NOTICE

■ **Cooling system coolant**

In order to ensure maximum performance of the traction battery cooling system and limit risks of battery short-circuit and other damage to your vehicle, Toyota recommends using “Toyota Genuine Traction Battery Coolant” or similar high-quality ethylene glycol-based, low electric conductivity coolant, non-amine and non-borate coolant withazole additives.

Toyota cannot guarantee that the use of a product other than “Toyota Genuine Traction Battery Coolant” will prevent risks of battery short-circuit or other damage.

Never use water as it will cause damage.

Do not reuse coolant that has been removed from the radiator.

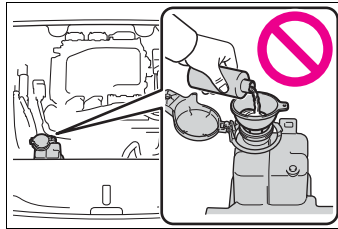

Heater system

| | |
|--------------|--|
| Capacity | 4.2 qt. (4.0 L, 3.5 Imp. qt.) |
| Coolant type | Use either of the following: <ul style="list-style-type: none"> • “Toyota Super Long Life Coolant” • Similar high-quality ethylene glycol-based non-silicate, non-amine, non-nitrite, and non-borate coolant with long-life hybrid organic acid technology Do not use plain water alone. |

Electrical system (12-volt battery)

| | |
|--|--|
| Specific voltage reading at 68°F (20°C): | 12.0 V or More In the case the voltage is less than standard, charge battery. (Voltage is checked 20 minutes after the motor and all lights turned off.) |
| Charging rates | 5 A max. |

Front eAxle

| | |
|------------------|------------------------------|
| Fluid capacity * | 4.1 qt. (3.9 L, 3.4 Imp.qt.) |
| Fluid type | e-Transaxle Fluid TE |

*: The fluid capacity is a reference quantity.
If replacement is necessary, contact your Toyota dealer.

 NOTICE

Front eAxle fluid type

Using transaxle fluid other than the above type may cause abnormal noise or vibration, or ultimately damage the front eAxle of your vehicle.

Rear eAxle (AWD models)

| | |
|------------------|------------------------------|
| Fluid capacity * | 3.3 qt. (3.1 L, 2.7 Imp.qt.) |
| Fluid type | e-Transaxle Fluid TE |

*: The fluid capacity is the quantity of reference.
If replacement is necessary, contact your Toyota dealer.

 NOTICE

Rear eAxle fluid type

Using transaxle fluid other than the above type may cause abnormal noise or vibration, or ultimately damage the rear eAxle of your vehicle.

Brakes

| | |
|---------------------------------------|---|
| Pedal clearance ^{*1} | 2.28 in. (58 mm) Min. |
| Pedal free play | 0.04 - 0.24 in. (1.0 - 6.0 mm) |
| Parking brake indicator ^{*2} | When pushing the parking brake switch for 1 to 4 seconds: turns off When pulling the parking brake switch for 1 to 4 seconds: comes on |
| Fluid type | FMVSS No.116 DOT 3 or SAE J1703 FMVSS No.116 DOT 4 or SAE J1704 |

*1: Minimum pedal clearance when depressed with a force of 66 lbf (300 N, 31 kgf) while the EV system is operating.

*2: Make sure to confirm that the brake system warning light (yellow) does not illuminate. (If the brake system warning light illuminates, refer to P.513)

Steering

| | |
|-----------|---------------------------|
| Free play | Less than 1.2 in. (30 mm) |
|-----------|---------------------------|

Tires and wheels

► Vehicles with 18-inch wheels

| | |
|---|---|
| Tire size | 235/60R18 103V |
| Tire inflation pressure (Recommended cold tire inflation pressure) | Front: 38 psi (260 kPa, 2.6 kgf/cm ² or bar) Rear: 38 psi (260 kPa, 2.6 kgf/cm ² or bar) |
| Wheel size | 18 x 7 1/2J |
| Wheel bolt torque | 103 ft•lbf (140 N•m, 14.3 kgf•m) |

► Vehicles with 20-inch wheels

| | |
|---|---|
| Tire size | 235/50R20 100V |
| Tire inflation pressure (Recommended cold tire inflation pressure) | Front: 38 psi (260 kPa, 2.6 kgf/cm ² or bar) Rear: 38 psi (260 kPa, 2.6 kgf/cm ² or bar) |
| Wheel size | 20 x 7 1/2J |
| Wheel bolt torque | 103 ft•lbf (140 N•m, 14.3 kgf•m) |

Tire information

Typical tire symbols

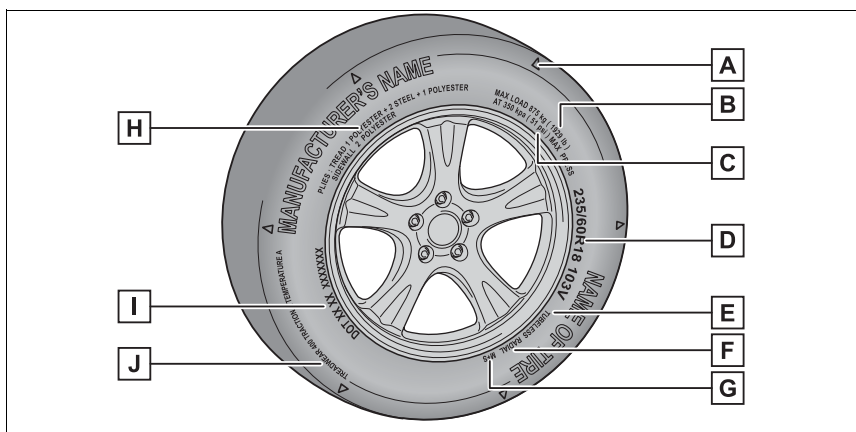

A Location of treadwear indicators (→P.472)

B Load limit at maximum cold tire inflation pressure (→P.560)

C Maximum cold tire inflation pressure (→P.560)

This means the pressure to which a tire may be inflated.

D Tire size (→P.557)

E TUBELESS or TUBE TYPE

A tubeless tire does not have a tube and air is directly put into the tire. A tube type tire has a tube inside the tire and the tube maintains the air pressure.

F Radial tires or bias-ply tires

A radial tire has "RADIAL" on the sidewall. A tire not marked "RADIAL" is a bias-ply tire.

G Summer tires or all season tires (→P.472)

An all season tire has "M+S" on the sidewall. A tire not marked "M+S" is a summer tire.

H Tire ply composition and materials

Ply is layers of rubber-coated parallel cords. Cords are the strands which form the plies in a tire.

I DOT and Tire Identification Number (TIN) (→P.557)

J Uniform tire quality grading

For details, see “Uniform Tire Quality Grading” that follows.

Typical DOT and Tire Identification Number (TIN)

► Type A

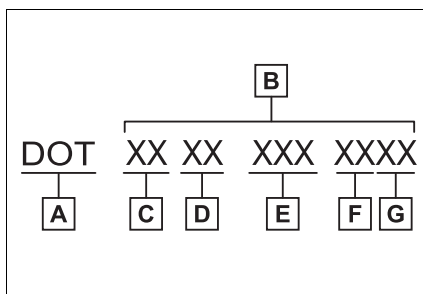

- A** DOT symbol*
- B** Tire Identification Number (TIN)
- C** Tire manufacturer’s identification mark
- D** Tire size code
- E** Manufacturer’s optional tire type code (3 or 4 letters)
- F** Manufacturing week
- G** Manufacturing year

*: The DOT symbol certifies that the tire conforms to applicable Federal Motor Vehicle Safety Standards.

► Type B

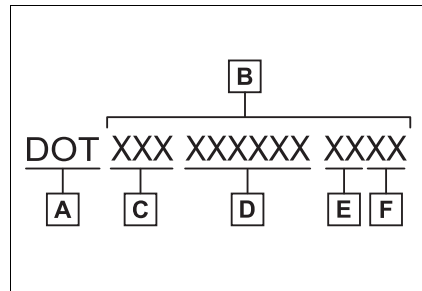

- A** DOT symbol*
- B** Tire Identification Number (TIN)
- C** Tire manufacturer’s identification mark
- D** Manufacturer’s code
- E** Manufacturing week
- F** Manufacturing year

*: The DOT symbol certifies that the tire conforms to applicable Federal Motor Vehicle Safety Standards.

Tire size

■ **Typical tire size information**

The illustration indicates typical tire size.

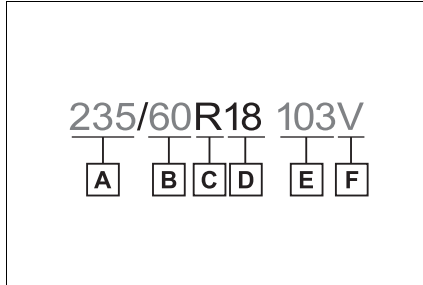

- A** Section width (millimeters)
- B** Aspect ratio (tire height to section width)
- C** Tire construction code (R = Radial, D = Diagonal)
- D** Wheel diameter (inches)
- E** Load index (2 digits or 3 digits)
- F** Speed symbol (alphabet with one letter)

■ **Tire dimensions**

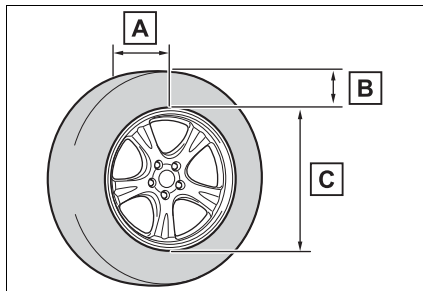

- A** Section width
- B** Tire height
- C** Wheel diameter

Tire section names

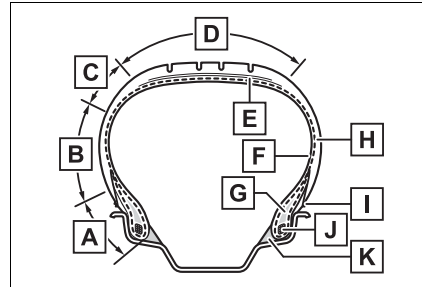

- A** Bead
- B** Sidewall
- C** Shoulder
- D** Tread
- E** Belt
- F** Inner liner
- G** Reinforcing rubber
- H** Carcass
- I** Rim lines
- J** Bead wires
- K** Chafer

Uniform Tire Quality Grading

This information has been prepared in accordance with regulations issued by the National Highway Traffic Safety Administration of the U.S. Department of Transportation.

It provides the purchasers and/or prospective purchasers of Toyota vehicles with informa-

tion on uniform tire quality grading.

Your Toyota dealer will help answer any questions you may have as you read this information.

■ DOT quality grades

All passenger vehicle tires must conform to Federal Safety Requirements in addition to these grades. Quality grades can be found where applicable on the tire sidewall between tread shoulder and maximum section width.

For example: Treadwear 200 Traction AA Temperature A

■ Treadwear

The treadwear grade is a comparative rating based on the wear rate of the tire when tested under controlled conditions on a specified government test course.

For example, a tire graded 150 would wear one and a half (1 - 1/2) times as well on the government course as a tire graded 100.

The relative performance of tires depends upon the actual conditions of their use. Performance may differ significantly from the norm due to variations in driving habits, service practices and differences in road characteristics and climate.

■ Traction AA, A, B, C

The traction grades, from highest to lowest, are AA, A, B and C, and they represent the tire's ability to stop on wet pavement

as measured under controlled conditions on specified government test surfaces of asphalt and concrete.

A tire marked C may have poor traction performance.

Warning: The traction grade assigned to this tire is based on braking (straight ahead) traction tests and does not include cornering (turning) traction.

■ Temperature A, B, C

The temperature grades are A (the highest), B, and C, representing the tire's resistance to the generation of heat and its ability to dissipate heat when tested under controlled conditions on a specified indoor laboratory test wheel.

Sustained high temperature can cause the material of the tire to degenerate and reduce tire life, and excessive temperature can lead to sudden tire failure.

Grade C corresponds to a level of performance which all passenger car tires must meet under the Federal Motor Vehicle Safety Standard No. 109.

Grades B and A represent higher levels of performance on the laboratory test wheel than the minimum required by law.

Warning: The temperature grades of a tire assume that it is properly inflated and not overloaded.

Excessive speed, underinflation, or excessive loading, either separately or in combination, can cause

heat buildup and possible tire failure.

Glossary of tire terminology

| Tire related term | Meaning |
|--------------------------------|---|
| Cold tire inflation pressure | Tire pressure when the vehicle has been parked for three hours or more, or has not been driven more than 1 mile or 1.5 km under that condition |
| Maximum inflation pressure | The maximum cold inflated pressure to which a tire may be inflated, shown on the sidewall of the tire |
| Recommended inflation pressure | Cold tire inflation pressure recommended by a manufacturer |
| Accessory weight | The combined weight (in excess of those standard items which may be replaced) of transmission, power steering, power brakes, power windows, power seats, radio and heater, to the extent that these items are available as factory-installed equipment (whether installed or not) |
| Curb weight | The weight of a motor vehicle with standard equipment, including the maximum capacity of traction battery and coolant, and if so equipped, air conditioning and additional weight optional traction motor |
| Maximum loaded vehicle weight | The sum of: (a) Curb weight (b) Accessory weight (c) Vehicle capacity weight (d) Production options weight |
| Normal occupant weight | 150 lb. (68 kg) times the number of occupants specified in the second column of Table 1* that follows |
| Occupant distribution | Distribution of occupants in a vehicle as specified in the third column of Table 1* below |

| Tire related term | Meaning |
|---|--|
| Production options weight | The combined weight of installed regular production options weighing over 5 lb. (2.3 kg) in excess of the standard items which they replace, not previously considered in curb weight or accessory weight, including heavy duty brakes, ride levelers, roof rack, heavy duty battery, and special trim |
| Rim | A metal support for a tire or a tire and tube assembly upon which the tire beads are seated |
| Rim diameter (Wheel diameter) | Nominal diameter of the bead seat |
| Rim size designation | Rim diameter and width |
| Rim type designation | The industry manufacturer's designation for a rim by style or code |
| Rim width | Nominal distance between rim flanges |
| Vehicle capacity weight (Total load capacity) | The rated cargo and luggage load plus 150 lb. (68 kg) times the vehicle's designated seating capacity |
| Vehicle maximum load on the tire | The load on an individual tire that is determined by distributing to each axle its share of the maximum loaded vehicle weight, and dividing by two |
| Vehicle normal load on the tire | The load on an individual tire that is determined by distributing to each axle its share of curb weight, accessory weight, and normal occupant weight (distributed in accordance with Table 1* below), and dividing by two |
| Weather side | The surface area of the rim not covered by the inflated tire |
| Bead | The part of the tire that is made of steel wires, wrapped or reinforced by ply cords and that is shaped to fit the rim |
| Bead separation | A breakdown of the bond between components in the bead |
| Bias ply tire | A pneumatic tire in which the ply cords that extend to the beads are laid at alternate angles substantially less than 90 degrees to the center-line of the tread |

| Tire related term | Meaning |
|----------------------------|---|
| Carcass | The tire structure, except tread and sidewall rubber which, when inflated, bears the load |
| Chunking | The breaking away of pieces of the tread or sidewall |
| Cord | The strands forming the plies in the tire |
| Cord separation | The parting of cords from adjacent rubber compounds |
| Cracking | Any parting within the tread, sidewall, or innerliner of the tire extending to cord material |
| CT | A pneumatic tire with an inverted flange tire and rim system in which the rim is designed with rim flanges pointed radially inward and the tire is designed to fit on the underside of the rim in a manner that encloses the rim flanges inside the air cavity of the tire |
| Extra load tire | A tire designed to operate at higher loads and at higher inflation pressures than the corresponding standard tire |
| Groove | The space between two adjacent tread ribs |
| Innerliner | The layer(s) forming the inside surface of a tubeless tire that contains the inflating medium within the tire |
| Innerliner separation | The parting of the innerliner from cord material in the carcass |
| Intended outboard sidewall | (a)The sidewall that contains a whitewall, bears white lettering, or bears manufacturer, brand, and/or model name molding that is higher or deeper than the same molding on the other sidewall of the tire, or (b)The outward facing sidewall of an asymmetrical tire that has a particular side that must always face outward when mounted on a vehicle |
| Light truck (LT) tire | A tire designated by its manufacturer as primarily intended for use on lightweight trucks or multipurpose passenger vehicles |

| Tire related term | Meaning |
|--|---|
| Load rating | The maximum load that a tire is rated to carry for a given inflation pressure |
| Maximum load rating | The load rating for a tire at the maximum permissible inflation pressure for that tire |
| Maximum permissible inflation pressure | The maximum cold inflation pressure to which a tire may be inflated |
| Measuring rim | The rim on which a tire is fitted for physical dimension requirements |
| Open splice | Any parting at any junction of tread, sidewall, or innerliner that extends to cord material |
| Outer diameter | The overall diameter of an inflated new tire |
| Overall width | The linear distance between the exteriors of the sidewalls of an inflated tire, including elevations due to labeling, decorations, or protective bands or ribs |
| Passenger car tire | A tire intended for use on passenger cars, multi-purpose passenger vehicles, and trucks, that have a gross vehicle weight rating (GVWR) of 10,000 lb. or less. |
| Ply | A layer of rubber-coated parallel cords |
| Ply separation | A parting of rubber compound between adjacent plies |
| Pneumatic tire | A mechanical device made of rubber, chemicals, fabric and steel or other materials, that, when mounted on an automotive wheel, provides the traction and contains the gas or fluid that sustains the load |
| Radial ply tire | A pneumatic tire in which the ply cords that extend to the beads are laid at substantially 90 degrees to the centerline of the tread |
| Reinforced tire | A tire designed to operate at higher loads and at higher inflation pressures than the corresponding standard tire |
| Section width | The linear distance between the exteriors of the sidewalls of an inflated tire, excluding elevations due to labeling, decoration, or protective bands |

| Tire related term | Meaning |
|----------------------------|---|
| Sidewall | That portion of a tire between the tread and bead |
| Sidewall separation | The parting of the rubber compound from the cord material in the sidewall |
| Snow tire | A tire that attains a traction index equal to or greater than 110, compared to the ASTM E-1136 Standard Reference Test Tire, when using the snow traction test as described in ASTM F-1805-00, Standard Test Method for Single Wheel Driving Traction in a Straight Line on Snow-and Ice-Covered Surfaces, and which is marked with an Alpine Symbol () on at least one sidewall |
| Test rim | The rim on which a tire is fitted for testing, and may be any rim listed as appropriate for use with that tire |
| Tread | That portion of a tire that comes into contact with the road |
| Tread rib | A tread section running circumferentially around a tire |
| Tread separation | Pulling away of the tread from the tire carcass |
| Treadwear indicators (TWI) | The projections within the principal grooves designed to give a visual indication of the degrees of wear of the tread |
| Wheel-holding fixture | The fixture used to hold the wheel and tire assembly securely during testing |

* : Table 1 — Occupant loading and distribution for vehicle normal load for various designated seating capacities

| Designated seating capacity, Number of occupants | Vehicle normal load, Number of occupants | Occupant distribution in a normally loaded vehicle |
|--|--|--|
| 2 through 4 | 2 | 2 in front |
| 5 through 10 | 3 | 2 in front, 1 in second seat |





| Designated seating capacity, Number of occupants | Vehicle normal load, Number of occupants | Occupant distribution in a normally loaded vehicle |
|--|--|---|
| 11 through 15 | 5 | 2 in front, 1 in second seat, 1 in third seat, 1 in fourth seat |
| 16 through 20 | 7 | 2 in front, 2 in second seat, 2 in third seat, 1 in fourth seat |

Customizable features

Your vehicle includes a variety of electronic features that can be personalized to suit your preferences. The settings of these features can be changed using the multi-information display, multimedia system, or at your Toyota dealer.

Customizing vehicle features

■ Changing using the multi-information display

- 1 Press  or  of the meter control switches and select .
- 2 Press  or  of the meter control switches, select the item.
- 3 To switch the function on and off, press OK icon to switch to the desired setting.
- 4 To perform detailed setting of the function, press and hold

OK and display the setting screen.

The method of detailed setting differs for each screen. Please refer to the advice sentence displayed on the screen.

To go back to the previous screen or exit the customize mode, press .

■ Changing by using the multimedia system

- 1 Select  on the main menu.
- 2 Select "Vehicle customize".
- 3 According to the display, select the desired setting.

Various setting can be changed.

Refer to the list of settings that can be changed for details.

■ When customizing using the multimedia system or multi-information display

Stop the vehicle in a safe place, apply the parking brake, and shift the shift lever to P. Also, to prevent 12-volt battery discharge, leave the EV system operating while customizing the features.

NOTICE

■ During customization

To prevent 12-volt battery discharge, ensure that the EV system is operating while customizing features.

Customizable Features

Some function settings are changed simultaneously with other functions being customized. Contact your Toyota dealer for further details.

- A** Settings that can be changed using the multimedia system
- B** Settings that can be changed using the multi-information display
- C** Settings that can be changed by your Toyota dealer

Definition of symbols: O = Available, – =Not available

■ **Charging system (→P.105, 113)**

| Function | Default setting | Customized setting | A | B | C |
|-------------------|-----------------|--------------------|---|---|---|
| Charging current | MAX | 8A | O | O | – |
| | | 16A | | | |
| Charging limit | Full | 90% | O | O | – |
| | | 80% | | | |
| | | 70% | | | |
| | | 60% | | | |
| | | 50% | | | |
| DC charging power | MAX | 125 kW | O | O | – |
| | | 100 kW | | | |
| | | 75 kW | | | |
| | | 50 kW | | | |
| Connector lock | Auto Lock | Off | O | O | – |
| | | Auto Lock & Unlock | | | |
| Battery cooler | On | Off | O | O | – |

■ **Gauges, meters and multi-information display (→P.152, 155)**

| Function *1 | Default setting | Customized setting | A | B | C |
|-------------|----------------------|----------------------------------|---|---|---|
| Language | English | French | – | O | – |
| | | Spanish | | | |
| Units | miles (miles/kWh) | km (kWh/100km) km (km/kWh) | – | O | – |

| Function* ¹ | Default setting | Customized setting | A | B | C |
|-----------------------------|---|--|---|---|---|
| | | | | | |
| Power Consumption | Total average (Average power consumption [after reset]) | Trip average (Average power consumption [after start]) | — | O | — |
| Audio system linked display | On | Off | — | O | — |
| AWD* ² | On | Off | — | O | — |
| Drive Info Type | After Start | After Reset | — | O | — |
| Drive Info Items | Distance | Average Speed | — | O | — |
| | | Total Time | | | |
| Pop-up display | On | Off | — | O | — |
| Closing display | Drive Info | Charging Schedule | — | O | — |
| Suggestion function | On | On (when the vehicle is stopped) | O | — | O |
| | | Off | | | |

*1: For details about each function: →P.158

*2: If equipped

■ **Rear seat reminder (→P.169)**

| Function | Default setting | Customized setting | A | B | C |
|---|-----------------|--------------------|---|---|---|
| | | | | | |
| Indication to prevent misplacement in the rear seat | On | Off | — | O | — |

■ Door lock (→P.167, 539)

| Function | Default setting | Customized setting | A | B | C |
|-----------------------------------|---|---|---|---|---|
| Unlocking using a mechanical key | Driver's door unlocked in first step, all doors unlocked in second step | All doors unlocked in first step | - | - | O |
| Automatic door locking function | Shift position linked door locking operation | Off | O | - | O |
| | | Speed linked door locking operation | O | - | O |
| Automatic door unlocking function | Shift position linked door unlocking operation | Off | O | - | O |
| | | Driver's door linked door unlocking operation | O | - | O |

■ Smart key system and wireless remote control (→P.164, 187)

| Function | Default setting | Customized setting | A | B | C |
|--|-----------------|--------------------|---|---|---|
| Operation signal (emergency flashers) | On | Off | O | - | O |
| Operation buzzer volume | 5 | Off | O | - | O |
| | | 1 to 7 | O | - | O |
| Time elapsed before the automatic door lock function is activated if a door is not opened after being unlocked | 60 seconds | Off | O | - | O |
| | | 30 seconds | O | - | O |
| | | 120 seconds | O | - | O |
| Open door reminder buzzer | On | Off | - | - | O |

■ Smart key system (→P.187)

| Function | Default setting | Customized setting | A | B | C |
|----------------------|-----------------|--------------------|---|---|---|
| Smart key system | On | Off | - | - | O |
| Smart door unlocking | Driver's door | All the doors | O | - | O |

| Function | Default setting | Customized setting | A | B | C |
|--|-----------------|--------------------|---|---|---|
| Number of consecutive door lock operations | 2 times | As many as desired | - | - | O |
| Time elapsed before unlocking all the door when gripping and holding the driver's door handle* | 2 seconds | Off | | | |
| | | 1.5 seconds | - | - | O |
| | | 2.5 seconds | | | |

*: This setting can be changed when the smart door unlocking setting is set to Driver's door.

■ Wireless remote control (→P.164)

| Function | Default setting | Customized setting | A | B | C |
|---|---|----------------------------------|---|---|---|
| Wireless remote control | On | Off | - | - | O |
| Unlocking operation | Driver's door unlocked in first step, all doors unlocked in second step | All doors unlocked in first step | O | - | O |
| Theft deterrent panic mode | On | Off | - | - | O |
| Locking operation when door opened | On | Off | O | - | O |
| The function that activates the  switch of the wireless remote control when locking the door* (→P.175) | On (Unlocking all the door) | Off | | | |
| | | On (Unlocking back door only) | - | - | O |

*: If equipped

■ Power back door* (→P.175)

| Function | Default setting | Customized setting | A | B | C |
|----------------------------------|-----------------|--------------------|---|---|---|
| Power back door opening position | 5 | 1 to 4 | - | O | - |
| Power back door operation | On | Off | - | O | - |

| Function | Default setting | Customized setting | A | B | C |
|--|-----------------|--------------------|---|---|---|
| | | | | | |
| Buzzer volume | Level 3 | Level 1 | - | O | - |
| | | Level 2 | | | |
| Operation buzzer | Off | On | - | - | O |
| Hands Free Power Back Door (kick sensor)* | On | Off | - | O | O |
| Kick in buzzer (kick sensor)* | On | Off | - | - | O |
| Hands Free Power Back Door (kick sensor) when the power switch is OFF* | On | Off | - | - | O |

*: If equipped

■ Power windows (→P.212)

| Function | Default setting | Customized setting | A | B | C |
|--|-----------------|--------------------|---|---|---|
| | | | | | |
| Key linked operation (open) | Off | On | - | - | O |
| Key linked operation (close) | Off | On | - | - | O |
| Wireless remote control linked operation (open) | Off | On | - | - | O |
| Wireless remote control linked operation signal (buzzer) | On | Off | - | - | O |

■ Power switch (→P.234)

| Function | Customized setting | A | B | C |
|----------|--------------------|---|---|---|
| ACC mode | ON/OFF | O | - | O |

■ Lights (→P.248)

| Function | Default setting | Customized setting | A | B | C |
|------------------------|-----------------|--------------------|---|---|---|
| | | | | | |
| Daytime Running Lights | On | Off* | O | - | O |
| Light reminder buzzer | On | Off | - | - | O |

*: Except for Canada

■ Reverse warning buzzer

| Function | Default setting | Customized setting | A | B | C |
|---|-----------------|--------------------|---|---|---|
| Signal (buzzer) when the shift position is in R | Continual | Mute | – | – | O |

■ Automatic light control system (→P.248)

| Function | Default setting | Customized setting | A | B | C |
|--|-----------------|--------------------|---|---|---|
| Light sensor sensitivity | Standard | –2 to 2 | O | – | O |
| Time elapsed before headlights automatically turn off after doors are closed | 30 seconds | Off | O | – | O |
| | | 60 seconds | | | |
| | | 90 seconds | | | |
| Windshield wiper linked headlight illumination | On | Off | – | – | O |

■ PCS (Pre-Collision System) (→P.265)

| Function | Customized setting | A | B | C |
|----------------------|-----------------------|---|---|---|
| Pre-Collision System | ON/OFF | – | O | – |
| Warning timing | Later/Default/Earlier | – | O | – |

■ LDA (Lane Departure Alert) (→P.281)

| Function | Customized setting | A | B | C |
|-----------------------------|--------------------|---|---|---|
| Lane Departure Alert system | ON/OFF | – | O | – |
| Alert timing | Default/Earlier | – | O | – |
| Alert options | Vibration/Beep | – | O | – |

■ Dynamic radar cruise control (→P.288)

| Function | Customized setting | A | B | C |
|-----------------------|--------------------|---|---|---|
| Extended Resume Time | ON/OFF | – | O | – |
| Acceleration setting | High/Mid/Low | – | O | – |
| Guide message | ON/OFF | – | O | – |
| Curve speed reduction | OFF/High/Mid/Low | – | O | – |

■ **RSA (Road Sign Assist) (→P.286)**

| Function | Customized setting | A | B | C |
|----------------------------------|---|---|---|---|
| Road Sign Assist | ON/OFF | – | O | – |
| Excess speed notification method | None/Visual/Visual & Audible | – | O | – |
| Other notifications method | None/Visual/Visual & Audible | – | O | – |
| Excess speed notification level | 5 mph (10 km/h)/3 mph (5 km/h)/1 mph (2 km/h) | – | O | – |

■ **Driver break suggestion (→P.281)**

| Function | Customized setting | A | B | C |
|-------------------------|--------------------|---|---|---|
| Driver break suggestion | ON/OFF | – | O | – |

■ **BSM (Blind Spot Monitor)* (→P.302)**

| Function | Default setting | Customized setting | A | B | C |
|--|-----------------|--------------------|---|---|---|
| BSM (Blind Spot Monitor) | On | Off | – | O | – |
| Outside rear view mirror indicator brightness | Bright | Dim | – | O | – |
| Alert timing for presence of approaching vehicle (sensitivity) | Intermediate | Early | – | O | – |
| | | Late | | | |

*: If equipped

■ **RCTA (Rear Cross Traffic Alert) function*¹ (→P.322)**

| Function | Default setting | Customized setting | A | B | C |
|--|-----------------|--------------------|---|---|---|
| RCTA (Rear Cross Traffic Alert) function | On | Off | – | O | – |
| Buzzer volume* ² | Level 2 | Level 1 | – | O | – |
| | | Level 3 | | | |

*¹: If equipped

*²: This setting is linked with the buzzer volume of the Intuitive parking assist function.

■ Intuitive parking assist^{*1} (→P.311)

| Function | Default setting | Customized setting | A | B | C |
|-----------------------------|-----------------|--------------------|---|---|---|
| Intuitive parking assist | On | Off | – | O | – |
| Buzzer volume ^{*2} | Level 2 | Level 1 | – | O | – |
| | | Level 3 | | | |

^{*1}: If equipped

^{*2}: This setting is linked with the buzzer volume of the RCTA (Rear Cross Traffic Alert) function.

■ RCD (Rear Camera Detection)^{*} (→P.328)

| Function | Default setting | Customized setting | A | B | C |
|--------------------------------------|-----------------|--------------------|---|---|---|
| RCD (Rear Camera Detection) function | On | Off | – | O | – |

^{*}: If equipped

■ PKSB (Parking Support Brake)^{*} (→P.331)

| Function | Default setting | Customized setting | A | B | C |
|---------------------------------------|-----------------|--------------------|---|---|---|
| PKSB (Parking Support Brake) function | On | Off | – | O | – |

^{*}: If equipped

■ SEA (Safe Exit Assist)^{*1} (→P.307)

| Function | Default setting | Customized setting | A | B | C |
|---|-----------------|--------------------|---|---|---|
| Safe Exit Assist | On | Off | – | O | – |
| Detection sensitivity ^{*2} | Middle | High | – | O | – |
| | | Low | | | |
| Outside rear view mirrors display ^{*2} | On | Off | – | O | – |

^{*1}: If equipped

^{*2}: This setting changes in accordance with My Settings

■ Automatic air conditioning system (→P.402)

| Function | Default setting | Customized setting | A | B | C |
|---------------------------|-----------------|--------------------|---|---|---|
| A/C Auto switch operation | On | Off | O | - | O |

■ Remote Air Conditioning System (→P.409)

| Function | Default setting | Customized setting | A | B | C |
|--|------------------------|------------------------|---|---|---|
| Operation using the "A/C" button on the wireless remote control | Press and hold (short) | Press once | - | - | O |
| | | Press twice | | | |
| | | Press and hold (long) | | | |
| | | Off | | | |
| Stopping operation using the "A/C" button on the wireless remote control | Press twice | Press once | - | - | O |
| | | Press and hold (short) | | | |
| | | Press and hold (long) | | | |
| | | Off | | | |

■ Illumination (→P.415)

| Function | Default setting | Customized setting | A | B | C |
|--|-----------------|--------------------|---|---|---|
| Time elapsed before the interior lights turn off | 15 seconds | Off | O | - | O |
| | | 7.5 seconds | | | |
| | | 30 seconds | | | |
| Operation after the power switch is turned off | On | Off | - | - | O |
| Operation when the doors are unlocked | On | Off | - | - | O |

| Function | Default setting | Customized setting | A | B | C |
|--|-----------------|--------------------|---|---|---|
| Operation when you approach the vehicle with the electronic key on your person | On | Off | - | - | O |
| Rear interior light and footwell lights* | On | Off | - | - | O |

*: If equipped

■ Vehicle customization

- When the speed linked door locking function and shift position linked door locking function are both on, the door lock operates as follows.
 - If the vehicle is started with all the doors locked, the speed linked door locking function would not operate.
 - If the vehicle is started with any door unlocked, the speed linked door locking function will operate.
 - When shifting the shift position to any position other than P, all the doors will be locked.
- When the smart key system is off, the selecting door to unlock cannot be customized.
- When the doors remain closed after unlocking the doors and the automatic door lock function is activated, the signals will be generated in accordance with the Operation signal (buzzer) and the Operation signal (emergency flashers) settings.

Items to initialize

The following items must be initialized for normal system operation after such cases as the battery being reconnected, or maintenance being performed on the vehicle:

List of the items to initialize

| Item | When to initialize | Reference |
|-------------------------------|---|---------------------------------------|
| Power back door* | <ul style="list-style-type: none"> • After reconnecting or changing the 12-volt battery • After changing a fuse | P.181 |
| Power window | <ul style="list-style-type: none"> • When functioning abnormally | P.212 |
| PKSB (Parking Support Brake)* | <ul style="list-style-type: none"> • After reconnecting or changing the 12-volt battery | P.335 |
| Tire pressure warning system | <ul style="list-style-type: none"> • When the specified tire inflation pressure has changed, such as due to carried load, etc. • When the tire inflation pressure is changed such as when the tire size is changed. | P.477 |
| Panoramic view monitor* | <ul style="list-style-type: none"> • 12-volt battery has been reinstalled • The steering wheel has been moved while the 12-volt battery was being reinstalled • 12-volt battery power is low | Refer to "MULTIMEDIA OWNER'S MANUAL". |

*: If equipped

For owners**10****10-1. For owners**

- Reporting safety defects for U.S. owners..... 580
- Reporting safety defects for Canadian owners 581
- Seat belt instructions for Canadian owners (in French)..... 581
- SRS airbag instructions for Canadian owners (in French)..... 583
- Headlight aim instructions for Canadian owners (in French)..... 590

Reporting safety defects for U.S. owners

If you believe that your vehicle has a defect which could cause a crash or could cause injury or death, you should immediately inform the National Highway Traffic Safety Administration (NHTSA) in addition to notifying Toyota Motor Sales, U.S.A., Inc. (Toll-free: 1-800-331-4331).

If NHTSA receives similar complaints, it may open an investigation, and if it finds that a safety defect exists in a group of vehicles, it may order a recall and remedy campaign. However, NHTSA cannot become involved in individual problems between you, your dealer, or Toyota Motor Sales, U.S.A., Inc.

To contact NHTSA, you may call the Vehicle Safety Hotline toll-free at 1-888-327-4236 (TTY: 1-800-424-9153); go to <http://www.safercar.gov>; or write to: Administrator, NHTSA, 1200 New Jersey Ave. S.E., Washington, DC 20590. You can also obtain other information about motor vehicle safety from <http://www.safercar.gov>.

Reporting safety defects for Canadian owners

Canadian customers who wish to report a safety-related defect to Transport Canada, Defects Investigations and Recalls, may telephone the toll-free hotline 1-800-333-0510, mail Transport Canada - ASFAD, 330 Sparks Street, Ottawa, ON, K1A 0N5, or complete the online form at <https://www.tc.gc.ca/recalls>.

Les clients canadiens désireux de rendre compte d'un défaut lié à la sécurité auprès de Transport Canada, Enquêtes sur les défauts et rappels, peuvent appeler gratuitement l'assistance téléphonique au 1-800-333-0510, écrire un courriel à Transports Canada - ASFAD, 330 Sparks Street, Ottawa, ON, K1A 0N5, ou remplir la déclaration en ligne à l'adresse <https://www.tc.gc.ca/rappels>.

Seat belt instructions for Canadian owners (in French)

The following is a French explanation of seat belt instructions extracted from the seat belt section in this manual.

See the seat belt section for more detailed seat belt instructions in English.

Utilisation correcte des ceintures de sécurité

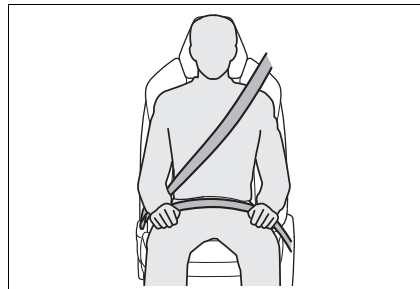

- Déroulez la sangle diagonale de telle sorte qu'elle passe bien sur l'épaule, sans pour autant être en contact avec le cou ou glisser de l'épaule.
- Placez la sangle abdominale le plus bas possible sur les hanches.
- Réglez la position du dossier de siège. Asseyez-vous le dos le plus droit possible et calez-vous bien dans le siège.
- Ne pas vriller la ceinture de

sécurité.

Entretien et nettoyage

■ Manipulation des ceintures de sécurité

Avec un chiffon ou une éponge, nettoyez à l'aide d'un savon doux et de l'eau tiède. Vérifiez aussi les ceintures régulièrement pour vous assurer qu'elles ne présentent pas d'usure excessive, d'effilochage ou de coupures.

AVERTISSEMENT

■ État et usure des ceintures de sécurité

Inspectez les ceintures de sécurité périodiquement. Contrôlez qu'elles ne sont pas entaillées, effilochées, et que leurs ancrages ne sont pas desserrés. Ne pas utiliser une ceinture de sécurité défectueuse avant qu'elle ne soit remplacée. Une ceinture de sécurité défectueuse n'apporte aucune garantie de protection de l'occupant contre des blessures graves, voire mortelles.

SRS airbag instructions for Canadian owners (in French)

The following is a French explanation of SRS airbag instructions extracted from the SRS airbag section in this manual.

See the SRS airbag section for more detailed SRS airbag instructions in English.

Système de coussins gonflables SRS

■ Emplacement des coussins gonflables SRS

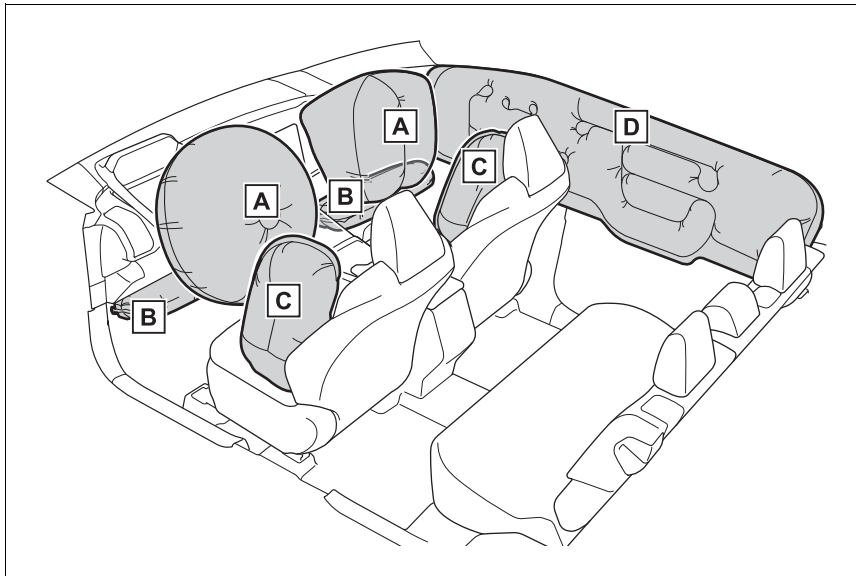

► Coussins gonflables SRS frontaux

A Coussin gonflable SRS conducteur/passager avant

Participent à la protection de la tête et du thorax du conducteur et du passager avant contre les chocs avec les éléments de l'habitacle

B Coussins gonflables SRS de genoux

Participe à la protection du conducteur et du passager avant

► Coussins gonflables SRS latéraux et rideau

C Coussins gonflables SRS latéraux avant

Participent à la protection du haut du corps des occupants aux places avant

D Coussins gonflables SRS rideau

- Participent principalement à la protection de la tête des occupants assis dans les sièges des places latérales
- Participent à empêcher les occupants d'être éjectés du véhicule en cas de retournement de celui-ci

■ **Composition du système de coussins gonflables SRS**

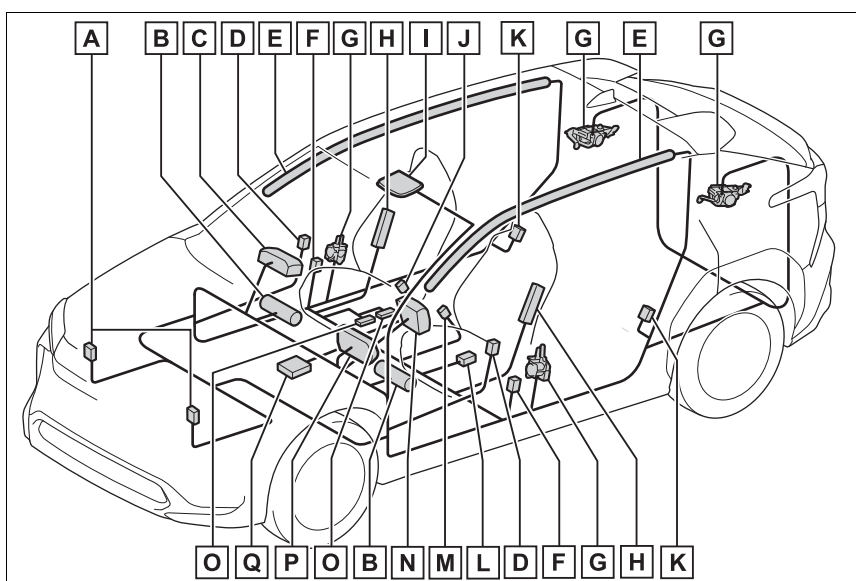

- A** Capteurs d'impact avant
- B** Coussin gonflable de genoux
- C** Coussin gonflable passager avant
- D** Capteurs d'impact latéral (porte avant)
- E** Coussins gonflables rideau
- F** Capteurs d'impact latéral (avant)
- G** Prétensionneurs et limiteurs d'effort de ceinture de sécurité
- H** Coussins gonflables latéraux
- I** Témoins indicateurs "AIR BAG ON" et "AIR BAG OFF"
- J** Contacteur de boucle de ceinture de sécurité passager avant
- K** Capteurs d'impact latéral (arrière)
- L** Capteur de position du siège conducteur

- M** Contacteur de boucle de ceinture de sécurité conducteur
- N** Coussin gonflable conducteur
- O** Capteurs de classification d'occupant du siège passager avant
- P** Témoin d'alerte SRS
- Q** Boîtier électronique de coussins gonflables

Votre véhicule est équipé de COUSSINS GONFLABLES INTELLIGENTS (ADVANCED AIRBAGS) conçus selon les normes de sécurité américaines applicables aux véhicules à moteur (FMVSS208). Le boîtier électronique de coussins gonflables (ECU) utilise les informations reçues des capteurs, etc. détaillés dans le schéma ci-dessus de composition du système pour commander le déploiement des coussins gonflables. Ces informations comprennent des informations sur la gravité de la collision et les occupants. Le déploiement rapide des coussins gonflables est obtenu au moyen d'une réaction chimique dans les dispositifs pyrotechniques, qui produit un gaz inoffensif permettant d'amortir le mouvement des occupants.



AVERTISSEMENT

■ Précautions avec les coussins gonflables SRS

Respectez les précautions suivantes concernant les coussins gonflables SRS.

À défaut, des blessures graves, voire mortelles, pourraient s'ensuivre.

- Le conducteur et tous les passagers à bord du véhicule doivent porter leur ceinture de sécurité correctement. Les coussins gonflables SRS sont des dispositifs de protection complémentaires aux ceintures de sécurité.

 **AVERTISSEMENT**

- Le coussin gonflable SRS conducteur se déploie avec une puissance considérable et peut occasionner des blessures graves, voire mortelles, notamment lorsque le conducteur se trouve très près du coussin gonflable. L'autorité fédérale chargée de la sécurité routière aux États-Unis, la NHTSA (National Highway Traffic Safety Administration) conseille:

Sachant que la zone de danger pour le coussin gonflable conducteur se trouve dans les premiers 2 à 3 in. (50 à 75 mm) du déploiement, placez-vous à 10 in. (250 mm) du coussin gonflable conducteur pour garantir une marge de sécurité suffisante. Cette distance est à mesurer entre le moyeu du volant de direction et le sternum. Si vous êtes assis à moins de 10 in. (250 mm), vous pouvez changer votre position de conduite de plusieurs façons:

- Reculez votre siège le plus possible, tout en continuant à pouvoir atteindre confortablement les pédales.

- Inclinez légèrement le dossier du siège.

Bien que les véhicules soient différents les uns des autres, la plupart des conducteurs peuvent s'asseoir à une distance de 10 in. (250 mm), même avec le siège conducteur complètement avancé, simplement en inclinant un peu le dossier de siège. Si vous avez des difficultés à voir la route après avoir incliné votre siège, utilisez un coussin ferme et antidérapant pour vous rehausser ou, si votre véhicule est équipé du réglage en hauteur du siège, remontez-le.

- Si votre volant de direction est réglable, inclinez-le vers le bas. Cela vous permet d'orienter le coussin gonflable vers votre buste plutôt que vers la tête et le cou.

Le siège doit être réglé selon les recommandations de la NHTSA ci-dessus, tout en conservant le contrôle des pédales et du volant, et la vue des commandes au tableau de bord.

⚠ AVERTISSEMENT

- Si vous attachez une rallonge de ceinture de sécurité aux boucles des ceintures de sièges avant, mais pas au pêne de la ceinture de sécurité proprement dite, les coussins gonflables SRS frontaux déterminent que le conducteur et le passager avant portent leur ceinture de sécurité, alors même qu'elle n'est pas attachée. Dans ce cas, les coussins gonflables SRS frontaux risquent de ne pas se déployer correctement en cas de collision, causant des blessures graves, voire mortelles. Veillez à porter la ceinture de sécurité avec la rallonge de ceinture de sécurité.

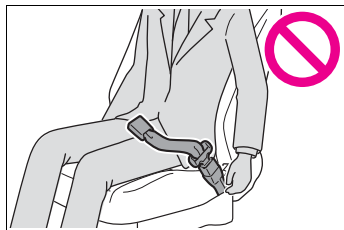

- Le coussin gonflable SRS passager avant se déploie également avec une puissance considérable et peut occasionner des blessures graves, voire mortelles, notamment lorsque le passager avant se trouve très près du coussin gonflable. Le siège du passager avant doit se trouver le plus loin possible du coussin gonflable et le dossier doit être réglé de manière à ce que le passager avant soit assis bien droit.

- Le déploiement d'un coussin gonflable peut infliger des blessures graves, voire mortelles, aux nourrissons et aux enfants mal assis et/ou mal attachés. Installez dans un siège de sécurité enfant les enfants trop jeunes pour pouvoir utiliser la ceinture de sécurité. Toyota recommande vivement que tous les nourrissons et enfants soient installés dans les sièges arrière du véhicule et convenablement attachés. Les sièges arrière sont plus sûrs pour les nourrissons et les enfants que le siège passager avant.
- Ne jamais installer un siège de sécurité enfant type dos à la route sur le siège passager avant, même si le témoin indicateur "AIR BAG OFF" est allumé. En cas d'accident, la force exercée par le déploiement rapide du coussin gonflable passager avant peut causer des blessures graves, voire mortelles à un enfant, si le siège de sécurité enfant type dos à la route est installé sur le siège passager avant.
- Ne pas s'asseoir sur le bord du siège et ne pas s'appuyer contre la planche de bord.

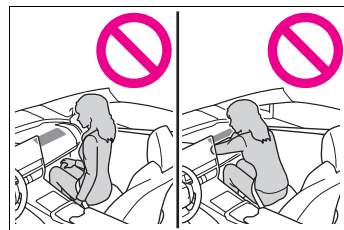

⚠ AVERTISSEMENT

- Ne pas laisser un enfant rester debout devant le coussin gonflable SRS passager avant ni assis sur les genoux du passager avant.

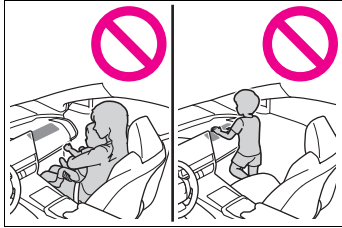

- Ne pas laisser les occupants des sièges avant voyager avec un objet sur les genoux.
- Ne pas s'appuyer contre la porte, contre le rail latéral de toit ou contre les montants avant, latéraux et arrière.



- Interdisez à quiconque de s'agenouiller sur le siège passager en appui contre la porte ou de sortir la tête ou les mains à l'extérieur du véhicule.

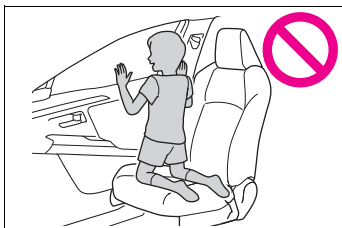

- Ne rien fixer ou disposer sur la planche de bord, la garniture centrale du moyeu de volant de direction et la partie inférieure du tableau de bord. Lors du déploiement des coussins gonflables SRS conducteur, passager avant et de genoux, tout objet risque de se transformer en projectile.

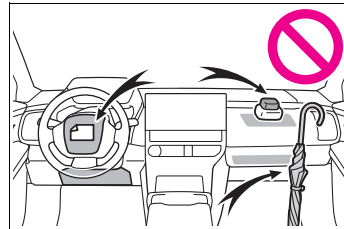

- Ne rien fixer sur les parties telles que les portes, la vitre de pare-brise, les vitres latérales, les montants avant et arrière, les rails latéraux de toit et les poignées de maintien.

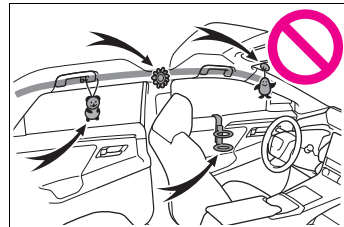

- Ne pas suspendre aux crochets à vêtements un cintre nu ni aucun objet dur ou tranchant. En cas de déploiement des coussins gonflables SRS rideau, tous ces objets pourraient se transformer en projectiles et causer des blessures graves, voire mortelles.
- Si une housse en vinyle recouvre la partie où le coussin gonflable SRS de genoux se déploie, veuillez à l'enlever.

 **AVERTISSEMENT**

- N'utilisez pour les sièges aucun accessoire venant recouvrir les parties où se déploient les coussins gonflables SRS latéraux, car il risquerait d'en gêner le déploiement. De tels accessoires peuvent empêcher les coussins gonflables SRS latéraux de s'activer correctement, neutraliser le système ou provoquer le déploiement accidentel des coussins gonflables SRS latéraux, provoquant ainsi des blessures graves, voire mortelles.
- Ne pas faire subir de chocs violents ni des pressions excessives aux parties renfermant les composants des coussins gonflables SRS, ni aux portes avant.
En effet, cela pourrait entraîner un mauvais fonctionnement des coussins gonflables SRS.
- Ne touchez aucun composant du système immédiatement après le déclenchement (déploiement) des coussins gonflables SRS, car ils sont alors encore très chauds.
- Si vous avez des difficultés à respirer après le déploiement des coussins gonflables SRS, ouvrez une porte ou une vitre pour faire entrer de l'air frais, ou bien descendez du véhicule si cela ne présente pas de danger. Retirez tout résidu dès que possible afin d'éviter d'éventuelles irritations de la peau.

● Si les parties renfermant les coussins gonflables SRS, par exemple la garniture centrale du volant de direction et les garnitures des montants avant et arrière, sont abîmées ou craquelées, faites-les remplacer par votre concessionnaire Toyota.

● Ne rien poser sur le siège du passager avant, comme un coussin par exemple. Cela a pour conséquence de répartir le poids du passager sur toute la surface du siège, ce qui empêche le capteur de détecter normalement le poids du passager. En conséquence, les coussins gonflables SRS frontaux du passager avant peuvent ne pas se déployer en cas de collision.

■ **Modification et élimination en fin de vie des éléments du système de coussins gonflables SRS**

Ne mettez pas à la casse votre véhicule et ne lui apportez aucune des modifications suivantes sans consulter votre concessionnaire Toyota. Les coussins gonflables SRS peuvent ne pas fonctionner correctement ou se déployer (se gonfler) accidentellement, provoquant ainsi des blessures graves, voire mortelles.

- Installation, dépose, démontage et réparations des coussins gonflables SRS
- Réparations, modifications, démontage ou remplacement du volant de direction, du tableau de bord, de la planche de bord, des sièges ou de leur garnissage, des montants avant, latéraux et arrière, des rails latéraux de toit, des panneaux de portes avant, des garnitures de portes avant ou des haut-parleurs de portes avant

⚠ AVERTISSEMENT

- Modifications du panneau de porte avant (percer un trou dedans, par exemple)
- Réparation ou modification des ailes avant, du bouclier avant, ou des flancs de l'habitacle
- Installation d'un équipement de protection sur la calandre (pare-buflle, pare-kangourou, etc.), d'un chasse-neige, de treuils ou d'une galerie de toit
- Modification des suspensions du véhicule
- Installation d'appareils électroniques, tels qu'un émetteur/récepteur radio ou lecteur de CD
- Aménagements du véhicule visant à permettre sa conduite par une personne atteinte d'un handicap physique

Headlight aim instructions for Canadian owners (in French)

The following is a French explanation of headlight aim instructions from the headlight aim section in this manual.

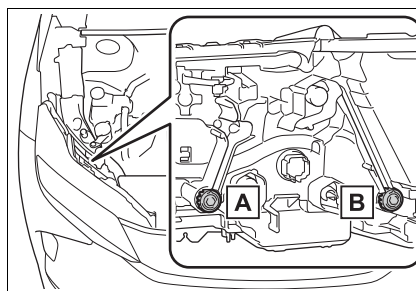
Boulons de réglage vertical

A Boulon de réglage A

B Boulon de réglage B

Avant de vérifier la portée des phares

- Assurez-vous que le réservoir de carburant du véhicule est plein et que la partie de carrosserie située autour des phares n'est pas déformée.
- Garez le véhicule sur un sol parfaitement horizontal.
- Assurez-vous que la pression de gonflage des pneus est au niveau prescrit.

- Demandez à quelqu'un de s'asseoir sur le siège du conducteur.
- Faites rebondir le véhicule à plusieurs reprises.

Réglage de la portée des phares

- 1 Tournez le boulon A vers la droite ou vers la gauche à l'aide d'un tournevis cruciforme.
Retenez le sens de rotation et le nombre de tours.

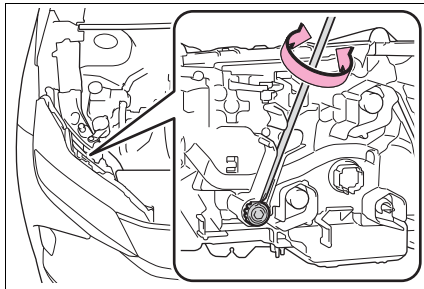

- 2 Tournez le boulon B du même nombre de tours et dans le même sens qu'à l'étape 1.

Si vous n'arrivez pas à régler vos phares en suivant cette procédure, apportez le véhicule chez votre concessionnaire Toyota afin qu'il

règle la portée des phares.

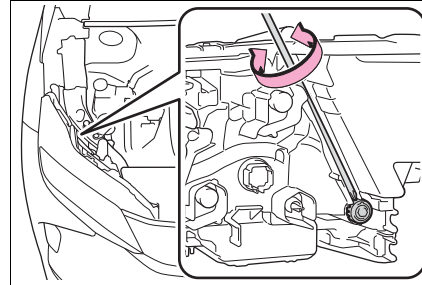

Index

593

What to do if... (Trouble-
shooting) 594
Alphabetical Index..... 597

What to do if... (Troubleshooting)

If you have a problem, check the following before contacting your Toyota dealer.

The doors cannot be locked, unlocked, opened or closed



You lose your keys

- If you lose your keys or mechanical keys, new genuine keys or mechanical keys can be made by your Toyota dealer. (→P.539)
- If you lose your electronic keys, the risk of vehicle theft increases significantly. Contact your Toyota dealer immediately. (→P.539)



The doors cannot be locked or unlocked

- Is the key battery weak or depleted? (→P.497)
- Is the power switch in ON? When locking the doors, turn the power switch off. (→P.234)
- Is the electronic key left inside the vehicle? When locking the doors, make sure that you have the

electronic key on your person.

- The function may not operate properly due to the condition of the radio wave. (→P.188)



The rear door cannot be opened

- Is the child-protector lock set? The rear door cannot be opened from inside the vehicle when the lock is set. Open the rear door from outside and then unlock the child-protector lock. (→P.171)

If you think something is wrong



The EV system does not start

- Is the charging cable connected to the vehicle? (→P.102)
- Did you press the power switch while firmly depressing the brake pedal? (→P.231)
- Is the electronic key anywhere detectable inside the vehicle? (→P.187)
- Is the electronic key battery weak or depleted? In this case, the EV system can be started in a temporary way. (→P.540)

- Is the 12-volt battery discharged? (→P.541)



The windows do not open or close by operating the power window switches

- Is the window lock switch pressed?
The power window except for the one at the driver's seat cannot be operated if the window lock switch is pressed. (→P.214)



The power switch is turned off automatically

- The auto power off function will be operated if the vehicle is left in ACC or ON (the EV system is not operating) for a period of time. (→P.235)



A warning buzzer sounds during driving

- The seat belt reminder light is flashing

Are the driver and the passengers wearing the seat belts? (→P.515, 516)

- The parking brake indicator is on

Is the parking brake released? (→P.245)

Depending on the situation, other types of warning buzzer may also sound. (→P.513, 522)



An alarm is activated and the horn sounds (if equipped)

- Did anyone inside the vehicle open a door during setting the alarm?
The sensor detects it and the alarm sounds. (→P.69)

To stop the alarm, turn the power switch to ON or start the EV system.



A warning buzzer sounds when leaving the vehicle

- Is the message displayed on the multi-information display?
Check the message on the multi-information display. (→P.522)



A warning light turns on or a warning message is displayed

- When a warning light turns on or a warning message is displayed, refer to P.513, 522.

When a problem has occurred



If you have a flat tire

- Stop the vehicle in a safe place and replace the flat tire with the spare tire. (→P.527)



The vehicle becomes stuck

- Try the procedure for when the vehicle becomes stuck in mud, dirt, or snow. (→P.547)

Alphabetical Index

A

- A/C** **402**
 - Air conditioning filter 494
 - Automatic air conditioning system 402
 - Front seat concentrated airflow mode (S-FLOW) 408
 - My Room Mode 129
 - Remote Air Conditioning System 409
 - “SYNC” mode 406
- ABS (Anti-lock Brake System)** **387**
 - Function 387
 - Warning light 514
- AC charging** **105**
- AC charging cable** **87**
 - CCID (Charging Circuit Interrupting Device) 89
 - If the AC charging connector cannot be unlocked 95
 - Indicator 90
 - Maintenance 92
 - Safety functions 89
- ACA (Active Cornering Assist)** **387**
- Acoustic Vehicle Alerting System** **74**
- Active Cornering Assist (ACA)** **387**
- Air conditioning filter** **494**
- Air conditioning system**
 - Air conditioning filter 494
 - Automatic air conditioning system 402
 - Front seat concentrated airflow mode (S-FLOW) 408
 - Remote Air Conditioning System 409
 - “SYNC” mode 406
- Airbags** **34**
 - Airbag operating conditions 36
 - Airbag precautions for your child 39
 - Correct driving posture 27
 - Curtain shield airbag operating conditions 37
 - Curtain shield airbag precautions 39
 - Front passenger occupant classification system 44
 - General airbag precautions 39
 - Locations of airbags 34
 - Modification and disposal of airbags 42
 - Side airbag operating conditions 37
 - Side airbag precautions 39
 - Side and curtain shield airbags operating conditions 37
 - Side and curtain shield airbags precautions 39
 - SRS airbag instructions for
 - Canadian owners 583
 - SRS airbags 34
 - SRS warning light 514
- Alarm** **69**
 - Alarm 69
 - Warning buzzer 513
- ALL AUTO (“ECO”) control** **400**
- Anchor brackets** **52, 61**
- Antenna (smart key system)** **187**
- Anti-lock Brake System (ABS)**
 - Warning light 514
- Anti-lock brake system (ABS)** **387**
 - Function 387
- Approach warning** **294**
- Armrest** **437**
- Assist grips** **438**
- Audio system-linked display** **157**
- Automatic air conditioning system** **402**
 - Air conditioning filter 494

Front seat concentrated airflow mode (S-FLOW)..... 408
 Remote Air Conditioning System 409
 “SYNC” mode 406
Automatic door locking and unlocking systems 171
Automatic High Beam (AHB). 250
Automatic light control system 248
Auxiliary box lights 415
Auxiliary boxes 420
Average power consumption 157
Average vehicle speed 158

B

Back door 172
 Hands Free Power Back Door 177
 Power back door 175
 Wireless remote control 164, 175
Back-up lights
 Replacing light bulbs 502
Battery (12-volt battery)
 If the 12-volt battery is discharged 541
 Preparing and checking before winter 393
 Replacing 544
 Warning light 513
Battery (traction battery) 72
 Charging 105, 113
 Location 72
 Specification 552
 Traction battery cooler 99
 Traction battery heater 99
 Warning messages 140
Battery Electric Vehicle driving tips 81
Blind Spot Monitor (BSM) 302
 Enabling/disabling the system 303

Bottle holders 420
Brake
 Brake Hold 246
 Fluid 554
 Parking brake 243
 Regenerative braking 73
 Warning light 513
Brake assist 387
 Brake Hold 246
Brake Override System 220
Break-in tips 220
Brightness control
 Instrument panel light control 155
BSM (Blind Spot Monitor) 302
 Enabling/disabling the system 303

C

Camera
 Digital Rear-view Mirror 206
 Front camera 260
 Toyota Teammate Advanced Park 352
Card holders 420
Care
 Aluminum wheels 449
 Brake calipers 449
 Exterior 448
 Interior 451
 Seat belts 451
Cargo and luggage 225
Cargo capacity 225, 228
Cargo hooks 421
CCID (Charging Circuit Interrupting Device) 89
 Indicator 90
 Operation 90
Ceintures de sécurité
 Comment porter votre ceinture de sécurité 581
Center console light 415
Chains 395

| | |
|---|-------------------------|
| Charging | 105, 113 |
| AC charging | 105 |
| AC charging cable | 87 |
| Charging components | 85 |
| Charging indicator | 90 |
| Charging methods | 98 |
| Charging procedure | 105, 113 |
| Charging schedule function.. | 118 |
| Charging time may increase | 104 |
| Charging tips | 100 |
| DC charging | 113 |
| Display . | 101, 121, 129, 131, 140 |
| Information related to charging display | 101, 121, 129, 131, 140 |
| Locking and unlocking the AC charging connector..... | 93 |
| My Room Mode | 129 |
| Opening and closing the charging port lids..... | 85 |
| Power sources precautions.... | 97 |
| Power sources that can be used | 96 |
| Safety functions..... | 89, 102 |
| Things to know before charging | 102 |
| Warning messages..... | 140 |
| When AC charging cannot be performed..... | 133 |
| When charging schedule function cannot be performed ... | 138 |
| When DC charging cannot be performed..... | 135 |
| Charging equipment | 85 |
| Charging methods..... | 98 |
| AC charging | 105 |
| DC charging | 113 |
| Charging ports | |
| Charging port lid..... | 85 |
| Locking and unlocking the AC charging connector..... | 93 |
| Opening and closing | 85 |
| Charging schedule function.. | 118 |
| Setting | 121 |
| Charging tips | 100 |
| Charging-linked functions | |
| My Room Mode | 98 |
| Traction battery cooler | 99 |
| Traction battery heater | 99 |
| Traction battery warming control | 99 |
| Child restraint system..... | 50 |
| Fixed with a LATCH system ... | 59 |
| Fixed with a seat belt..... | 54 |
| Front passenger occupant classification system | 44 |
| Points to remember | 50 |
| Riding with children | 49 |
| Types of child restraint system installation method | 52 |
| Using an anchor bracket | 61 |
| Child safety | 49 |
| 12-volt battery precautions ... | 544 |
| Airbag precautions | 39 |
| Back door precautions..... | 172 |
| Child restraint system..... | 52 |
| Electronic sunshade | 427 |
| How your child should wear the seat belt..... | 30 |
| Power window lock switch ... | 214 |
| Power window precautions... | 213 |
| Rear door child-protectors ... | 171 |
| Seat belt extender precautions | 30 |
| Seat belt precautions..... | 29, 49 |
| Child-protector..... | 171 |
| Cleaning | 448, 451 |
| Aluminum wheels | 449 |
| Brake calipers..... | 449 |
| Digital Rear-view Mirror | 206 |
| Exterior | 448 |
| Interior | 451 |
| Radar sensor | 261 |
| Seat belts | 451 |
| Clock..... | 152, 154 |

- Coat hooks** 437
 - Console box** 419
 - Coolant**
 - Capacity 552
 - Checking 465, 467
 - Preparing and checking before winter 393
 - Cooling system**
 - EV system overheating 545
 - Coussins gonflables**
 - Modification et élimination en fin de vie des coussins gonflables 589
 - Précautions avec les coussins gonflables latéraux 585
 - Précautions avec les coussins gonflables latéraux et rideau 585
 - Précautions avec les coussins gonflables pour votre enfant 585
 - Précautions avec les coussins gonflables rideau 585
 - Précautions générales avec les coussins gonflables 585
 - Cruise control**
 - Dynamic radar cruise control 288, 296
 - Warning lights 517
 - Cup holders** 419
 - Current Power consumption** . 157
 - Curtain shield airbags** 34
 - Customizable features** 566
- D**
- Daytime running light system** 248
 - Daytime running lights**
 - Replacing light bulbs 502
 - DC charging** 113
 - Deck board** 422
 - Deck under tray** 423
 - Defogger**
 - Outside rear view mirrors 404
 - Rear window 404
 - Windshield 403
 - Digital key** 165
 - Digital Rear-view Mirror** 201
 - Dimension** 550
 - Dinghy towing** 230
 - Display**
 - Charging 101, 121, 129, 131, 140
 - Cruise control 297
 - Dynamic radar cruise control 291
 - Intuitive parking assist 312
 - Multi-information display 155
 - Pedestrians Rear of the Vehicle 340
 - RCD (Rear Camera Detection) 328
 - Rear Camera Detection (RCD) 328
 - Warning message 522
 - Do-it-yourself maintenance** . 455, 460
 - Door lock**
 - Back door 172
 - Side doors 167
 - Smart key system 187
 - Wireless remote control 164
 - Door trim ornament lights** 415
 - Doors**
 - Automatic door locking and unlocking system 171
 - Back door 172
 - Door glasses 212
 - Door lock 167
 - Open door warning buzzer ... 170
 - Outside rear view mirrors 210
 - Rear door child-protectors 171
 - Side doors 167
 - Drive distance** 158
 - Drive information** 158
 - Drive-start control** 224
 - Driving** 219

Battery Electric Vehicle driving tips.....81
 Break-in tips220
 Correct posture27
 Procedures.....219
 Winter drive tips393
Driving assist information
 Warning light517
Driving information display...157
Driving range152
Driving support system information display157
Dynamic radar cruise control
288, 296
 Approach warning294
 Curve speed reduction function
295
 Warning lights.....518

E

ECB (Electronically Controlled Brake System)387
 Warning light513
Eco mode241
EDR (Event data recorder).....9
Elapsed time158
Electric motor (traction motor)
 Location.....72
Electric motor(traction motor)
 Identification number551
Electric Power Steering (EPS)
 Function387
 Warning light515
Electric Vehicle system features
72
Electric Vehicle system precautions.....76
Electronic key
 Battery-saving function.....188
 If the electronic key does not
 operate properly539
 Replacing the battery497

Electronic sunshade426
 Operation.....426
Electronically Controlled Brake System (ECB).....387
 Warning light.....513
Emergency Driving Stop System
299
Emergency flashers504
Emergency tire puncture repair kit527
 Storage location528
Emergency, in case of
 If a warning buzzer sounds ..513
 If a warning light turns on513
 If a warning message is displayed.....522
 If the 12-volt battery is discharged541
 If the electronic key does not
 operate properly539
 If the EV system will not start537
 If the vehicle is submerged or
 water on the road is rising ..506
 If you have a flat tire527
 If you lose your keys.....539
 If you think something is wrong
511
 If your vehicle becomes stuck
547
 If your vehicle has to be stopped
 in an emergency.....505
 If your vehicle needs to be towed
507
 If your vehicle overheats545
Engine
 Hood.....462
EPS (Electric Power Steering)
 Function.....387
 Warning light.....515
EV system72
 ACC234
 Acoustic Vehicle Alerting System

| | |
|--|----------|
| | 74 |
| Battery Electric Vehicle driving tips..... | 81 |
| Brake Override System | 220 |
| Drive-start control..... | 224 |
| Driving range | 83 |
| Electric Vehicle system precautions..... | 76 |
| Emergency shut off system.... | 80 |
| Features | 72 |
| How to start the EV system.. | 231 |
| How to use AC charging..... | 105 |
| How to use DC charging | 113 |
| If the EV system will not start | 537 |
| If your vehicle has to be stopped in an emergency..... | 505 |
| Ignition switch (power switch) | 231 |
| Overheating..... | 545 |
| Power meter..... | 152 |
| Power switch | 231 |
| Regenerative braking | 73 |
| Starting the EV system..... | 231 |
| Event data recorder (EDR)..... | 9 |

F

| | |
|--|------------|
| Flat tire | 527 |
| Tire pressure warning system | 474 |
| Floor mats | 26 |
| Fluid | |
| Brake..... | 554 |
| Front eAxle..... | 554 |
| Rear eAxle | 554 |
| Washer | 471 |
| Fog light | |
| Replacing light bulbs | 502 |
| Footwell lights | 415 |
| Front eAxle | |
| Fluid | 554 |
| Front electric motor (traction motor) | |

| | |
|---|------------|
| Specification | 551 |
| Front fog light | |
| Replacing light bulbs | 502 |
| Front interior lights | 416 |
| Front passenger occupant classification system | 44 |
| Front seat concentrated airflow mode (S-FLOW) | 408 |
| Front seats | 192 |
| Adjustment | 192 |
| Cleaning | 451 |
| Correct driving posture | 27 |
| Head restraints | 196 |
| Seat heaters | 411 |
| Seat ventilators..... | 411 |
| Front side marker lights..... | 248 |
| Light switch..... | 248 |
| Front turn signal lights | |
| Replacing light bulbs | 502 |
| Turn signal lever | 242 |
| Fuses | 499 |

G

| | |
|---------------------------------|------------|
| Garage door opener | 439 |
| Gauges | 152 |
| Grip Control | 385 |

H

| | |
|--|------------|
| Head restraints | 196 |
| Headlights | 248 |
| Automatic High Beam (AHB) | 250 |
| Light switch..... | 248 |
| Replacing light bulbs | 502 |
| Headlights aim | 501 |
| Headlight aim instructions for Canadian owners | 590 |
| Heated steering wheel..... | 411 |
| Heater system | |
| Capacity | 553 |

Heaters
 Automatic air conditioning system 402
 Heated steering wheel 412
 Outside rear view mirrors 404
 Seat heaters 411
 Traction battery heater 99
Hill-start assist control 387
Hood 462
Hooks
 Cargo hooks 421
 Coat hooks 437
 Retaining hooks (floor mat) 26
Horn 199

I

I/M test 459
Identification
 Electric motor (traction motor) 551
 Vehicle 550
If your vehicle overheats 545
Ignition switch (power switch) 231
 Auto power off function 235
 Changing the power switch modes 234
 If your vehicle has to be stopped in an emergency 505
 Starting the EV system 231
Illuminated entry system 415
Immobilizer system 68
Indicators 149
 Charging cable 90
 Charging indicator 86
 Charging indicator (CCID) 90
 Error warning indicator 90
 Power indicator 90
Initialization
 Electronic sunshade 426
 Items to initialize 577
 Parking Support Brake 335

Power back door 181
 Power windows 212
Inside door handle lights 415
Inside rear view mirror 200
Interior lights 415
Intuitive parking assist 311
 Enabling/disabling the system 312
 Function 311
 Warning lights 517

J

Jack
 Positioning a floor jack 464
 Vehicle-equipped jack 486
Jack handle 486
Jam protection function
 Power back door 179
 Power windows 212

K

Keyless entry
 Smart key system 187
 Wireless remote control 164
Keys 162
 Battery-saving function 188
 Digital key 165
 Electronic key 162
 If the electronic key does not operate properly 539
 If you lose your keys 539
 Key number plate 162
 Keyless entry 164, 187
 Mechanical key 164
 Power switch 231
 Replacing the battery 497
 Warning buzzer 187
 Wireless remote control key 164
Knee airbags 34

L

- Lane Departure Alert (LDA) ... 281**
 - Operation 281
 - Warning lights..... 516
- Lane Tracing Assist (LTA)..... 276**
 - Operation 276
 - Warning lights..... 516
- Language (multi-information display) 158, 567**
- LATCH anchors 59**
- LDA (Lane Departure Alert) ... 281**
 - Operation 281
 - Warning lights..... 516
- Lever**
 - Auxiliary catch lever 462
 - Hood lock release lever..... 462
 - Turn signal lever..... 242
 - Wiper lever 253
- License plate lights**
 - Light switch 248
 - Replacing light bulbs 502
- Light bulbs**
 - Replacing 502
- Lights**
 - Automatic High Beam (AHB) 250
 - Emergency flasher switch 504
 - Headlight switch 248
 - Interior light list 415
 - Interior lights..... 416
 - Luggage compartment light 174, 178
 - Personal lights..... 417
 - Replacing light bulbs 502
 - Turn signal lever..... 242
 - Vanity lights 428
- Load capacity 228**
- Locking and unlocking the AC charging connector..... 93**
- LTA (Lane Tracing Assist)..... 276**
 - Operation 276
 - Warning lights..... 516

Luggage compartment light 174, 178

Luggage cover 423

M**Maintenance**

- AC charging cable 92
- Do-it-yourself maintenance .. 460
- General maintenance 456
- Maintenance data 550
- Maintenance requirements... 455

Menu icons..... 156

Meter

- Clock 152
- Indicators..... 149
- Instrument panel light control 155
- Meter control switches 156
- Meters 152
- Multi-information display 155
- Settings 158, 566
- Units 567
- Warning lights..... 513
- Warning message..... 522

Mirrors

- Digital Rear-view Mirror 201
- Inside rear view mirror 200
- Outside rear view mirror defoggers 404
- Outside rear view mirrors 210
- Vanity mirrors..... 428

Motor

- Compartment..... 465

Multi-information display 155

- Audio system-linked display . 157
- Charging 101, 121, 129, 131, 140
- Clock 154
- Convenience Services (Suggestion function)..... 567
- Cruise control 297
- Driving information display ... 157
- Driving support system information display 157

Dynamic radar cruise control 291
 Language 567
 LDA (Lane Departure Alert) .. 285
 LTA (Lane Tracing Assist) 280
 Menu icons 156
 Meter control switches 156
 Navigation system-linked display
 157
 Power consumption 157
 Settings 158, 566
 Suggestion function 159
 Tire pressure 474
 Units 567
 Vehicle information display ... 158
 Warning message 522
My Room Mode 129
 Display 129
 Starting My Room Mode 129
 Warning messages 131

N

Navigation system-linked display
 157

O

Odometer 154
Odometer and trip meter display
 Display items 154
Open tray 420
Opener
 Back door 174, 176
 Garage door 439
Outer foot lights 415
Outside rear view mirrors 210
 Adjusting and folding 210
 BSM (Blind Spot Monitor) 302
 Outside rear view mirror defog-
 gers 404
 RCTA (Rear Cross Traffic Alert)
 322
 SEA (Safe Exit Assist) 307

Outside temperature 152

P

Panic mode 164
**Parking assist sensors (intuitive
 parking assist) 311**
Parking brake 243
 Operation 243
 Parking brake engaged warning
 buzzer 245
 Warning light 518
 Warning message 245
Parking lights
 Light switch 248
Parking Support Brake (PKSB)
 331
 Enabling/disabling the system
 333
PCS (Pre-Collision System) ... 265
 Enabling/disabling the system
 275
 Function 265
 Warning light 518
Personal lights 415, 417
 Switch 417
PKSB (Parking Support Brake)
 331
 Enabling/disabling the system
 333
 Moving Vehicle Rear of the Vehi-
 cle 339
 Pedestrians Rear of the Vehicle
 340
 Static Objects Around the Vehi-
 cle 342
 Static Objects Front and Rear of
 the vehicle 336
Power back door 175
Power back door switch 176
Power consumption 157
 Average power consumption 157
 Current power consumption . 157

- Power control unit coolant**
 Checking 465
 Preparing and checking before
 winter..... 393
 Radiator..... 466
- Power meter..... 152**
- Power outlets..... 428**
- Power sources..... 96**
- Power steering (Electric Power
 Steering system) 387**
- Power steering (Electric power
 steering system)**
 Warning light 515
- Power switch 231**
 Auto power off function 235
 Changing the power switch
 modes 234
 If your vehicle has to be stopped
 in an emergency..... 505
 Starting the EV system..... 231
- Power windows**
 Catch protection function 212
 Door lock linked window opera-
 tion 213
 Jam protection function 212
 Operation 212
 Window lock switch 214
- Pre-Collision System (PCS)... 265**
 Enabling/disabling the system
 275
 Function 265
 Warning light 518
- R**
- Radar cruise control 296**
- Radar cruise control (dynamic
 radar cruise control) 288**
- Radiant heaters 411**
- RCD (Rear Camera Detection)
 328**
 Enabling/disabling the system
 329
- RCTA (Rear Cross Traffic Alert)
 322**
 Enabling/disabling the system
 323
- Rear Camera Detection (RCD)
 328**
 Enabling/disabling the system
 329
- Rear Cross Traffic Alert (RCTA)
 322**
 Enabling/disabling the system
 323
- Rear eAxle**
 Fluid..... 554
- Rear electric motor (traction
 motor)**
 Specification 552
- Rear fog light**
 Replacing light bulbs 502
- Rear interior lights..... 416**
- Rear seat**
 Folding down the rear seatbacks
 194
- Rear seats 193**
 Adjustment 193
 Head restraints 196
 Seat heaters 411
- Rear side marker lights**
 Light switch..... 248
- Rear turn signal lights**
 Replacing light bulbs 502
 Turn signal lever 242
- Rear view mirror**
 Digital Rear-view Mirror 201
 Inside rear view mirror 200
 Outside rear view mirrors 210
- Rear window defogger 404**
- Regeneration Boost Switch... 240**
- Regenerative braking 73**
 Warning lights 513
- Remote Air Conditioning System
 409**

Replacing
 Electronic key battery 497
 Fuses 499
 Light bulbs 502
 Tires 485
Replacing the tire 485
Reporting safety defects for
Canadian owners 581
Reporting safety defects for U.S.
owners 580
Road Sign Assist (RSA) 286
Roof luggage carrier 225
RSA (Road Sign Assist) 286

S

Safe Exit Assist (SEA)
 Enabling/disabling the system
 308
Safety Connect 64
SEA (Safe Exit Assist) 307
 Enabling/disabling the system
 308
Seat belt reminder light . 515, 516
Seat belts 29
 Adjusting the seat belt shoulder
 anchor height 31
 Automatic Locking Retractor
 (ALR) 31
 Child restraint system installation
 54
 Cleaning and maintaining the
 seat belt 451
 Emergency Locking Retractor
 (ELR) 31
 How to wear your seat belt 30
 How your child should wear the
 seat belt 30
 Pregnant women, proper seat
 belt use 29
 Reminder light and buzzer . 515,
 516
 Seat belt extender 30

Seat belt instructions for Cana-
 dian owners 581
 Seat belt pretensioners 32
 SRS warning light 514
Seat heaters 411
Seat ventilators 411
Seating capacity 228, 550
Seats 192, 193
 Adjustment 192, 193
 Adjustment precautions 193
 Child seats/child restraint system
 installation 50
 Cleaning 451
 Folding down the rear seatbacks
 194
 Head restraints 196
 Properly sitting in the seat 27
 Seat heaters 411
 Seat ventilators 411
Secondary Collision Brake 388
Sécurité de l'enfant
 Précautions avec les coussins
 gonflables 585
Sensor
 Automatic headlight system . 248
 Automatic High Beam (AHB) 250
 BSM (Blind Spot Monitor) ... 303,
 308
 Digital Rear-view Mirror 205
 Dynamic radar cruise control 260
 Inside rear view mirror 201
 Intuitive parking assist 311
 LDA (Lane Departure Alert) .. 281
 LTA (Lane Tracing Assist) 276
 Moving Vehicle Rear of the Vehi-
 cle 303, 308
 Parking Support Brake function
 (static objects) 311
 PCS (Pre-Collision System) . 260
 Radar sensor 260
 Rain-sensing windshield wipers
 255

- RCTA (Rear Cross Traffic Alert) 308
- RCTA (Rear Crossing Traffic Alert)..... 303
- SEA (Safe Exit Assist) .. 303, 308
- Toyota Teammate Advanced Park..... 311
- Service plug** 76
- Shift lights**..... 415
- Side airbags** 34
- Side doors**..... 167
- Side marker lights**
 - Light switch 248
- Side mirrors** 210
 - Adjustment 210
 - BSM (Blind Spot Monitor)..... 302
 - Folding 210
 - Heaters..... 404
 - Outside rear view mirror defoggers 404
 - RCTA (Rear Cross Traffic Alert) 322
 - SEA (Safe Exit Assist) 307
- Side turn signal lights**
 - Replacing light bulbs 502
 - Turn signal lever..... 242
- Side windows** 212
- Smart key system**..... 187
 - Antenna location 187
 - Entry functions 167, 173
 - Starting the EV system..... 231
- Snow mode** 382
- Snow tires** 393
- SOC (State of Charge) gauge** 152
- Software update** 257
- “SOS” button**..... 64
- Specifications** 550
- Speedometer** 152
- SRS airbags** 34
- Steering wheel**..... 199
 - Adjustment 199
 - Heated steering wheel 411
 - Meter control switches..... 156
- Stop lights**
 - Replacing light bulbs 502
- Storage feature** 418
- Storage precautions**..... 418
- Stuck**
 - If the vehicle becomes stuck 547
- Suggestion function**..... 159
- Sun visors** 428
- Sunshade** 426
- Switches**
 - Automatic High Beam switch 250
 - Brake hold switch 246
 - Cruise control 297
 - Door lock switch 170
 - Dynamic radar cruise control 291
 - Eco mode 241
 - Electronic sunshade switch . 426
 - Emergency flashers switch... 504
 - Garage door opener switches 439
 - Grip Control 382, 385
 - Heated steering wheel..... 412
 - Ignition switch (power switch) 231
 - Light switch..... 248
 - LTA (Lane Tracing Assist) switch 279
 - Meter control switches..... 156
 - Outside rear view mirror switches..... 210
 - Parking brake switch 243
 - Power back door switch 176
 - Power switch 231
 - Power window switch 212
 - Radiant heaters 413
 - Rear window and outside rear view mirror defoggers switch 404
 - Regeneration Boost switch... 240
 - Seat heater switches 412
 - Snow mode switch 382

“SOS” button 64
 Tire pressure warning reset
 switch 477
 Vehicle-to-vehicle distance
 switch 291
 Ventilators (seat ventilators) .413
 VSC OFF switch..... 388
 Window lock switch 214
 Windshield defogger switch .403
 Windshield wipers and washer
 switch 253
 X-MODE switch 382
Switching the meter display.. 154
“SYNC” mode 406

T

Tail lights
 Light switch 248
 Replacing light bulbs 502
Theft deterrent system
 Alarm 69
 Immobilizer system 68
Tire inflation pressure..... 158
 Maintenance data 555
 Tire inflation pressure display
 function..... 474
 Warning buzzers 516
 Warning light 516
Tire information 556
 Glossary 560
 Size 557
 Tire identification number 557
 Tire section names 558
Tire pressure warning system
 **474**
 Function 474
 Installing tire pressure warning
 valves and transmitters 476
 Registering ID codes 481
 Registration of the position of
 each wheel 477
 Selecting wheel set 483

Setting the tire pressure 478
 Warning buzzers..... 516
 Warning light..... 516
Tires 472
 Chains 395
 Checking 472
 Emergency tire puncture repair
 kit..... 527
 Glossary 560
 If you have a flat tire 527
 Inflation pressure 491
 Information 556
 Replacing 485
 Rotating tires 474
 Size 555
 Snow tires 393
 Tire identification number 557
 Tire inflation pressure display
 function 474
 Tire pressure warning system
 474
 Uniform Tire Quality Grading 558
 Warning buzzers..... 516
 Warning light..... 516
Tools 486, 528
Top tether strap 61
Total load capacity 225, 228
Towing
 Dinghy towing 230
 Emergency towing 507, 509
 Towing eyelet..... 510
 Trailer sway control 387
 Trailer towing 229
Toyota Safety Sense 3.0..... 259
 Automatic High Beam (AHB) 250
 Dynamic radar cruise control 288
 Emergency Driving Stop System
 299
 LDA (Lane Departure Alert) .281
 LTA (Lane Tracing Assist) 276
 PCS (Pre-Collision System) .265
 RSA (Road Sign Assist)..... 286

Software update 257
Toyota Teammate Advanced
Park 344
Memory function 366
Parallel exiting function 364
Parallel parking function 360
Perpendicular exiting (forward/
reverse) function 359
Perpendicular parking (forward/
reverse) function 356
Remote control function 371
TRAC (Traction Control) 387
Traction battery 72
Charging 105, 113
Location 72
Specification 552
Traction battery cooler 99
Traction battery heater 99
Warning messages 140
Traction battery charge
Warning light 515
Traction Control (TRAC) 387
Trailer sway control 387
Trailer towing 229
Transmission 236
Trip meters 154
Turn signal lights
Replacing light bulbs 502
Turn signal lever 242

U

USB charging ports 429
Utility vehicle precautions 396

V

Vanity lights
Vanity lights 428
Vanity mirrors 428
Vanity lights 428
Vehicle data recordings 8
Vehicle identification number 550

Vehicle information display ... 158
Vehicle Stability Control (VSC)
..... 387
Ventilators (seat ventilators) . 411
VSC (Vehicle Stability Control)
..... 387

W

Warning buzzers

Acceleration Suppression at Low
Speed 268
Approach warning 294
Brake hold 519
Brake Override System 514
Brake system 513
Break suggestion function 284
Cruise control 517
Drive-Start Control 514
Dynamic radar cruise control 518
Electric power steering 515
Hands off steering wheel warn-
ing (LDA) 283
Hands off steering wheel warn-
ing (LTA) 278
Intuitive parking assist .. 319, 517
LDA (Lane Departure Alert) 281,
516
LTA (Lane Tracing Assist) ... 276,
516
Open door 170
Open hood 170
Open window 213
PCS (Pre-Collision System) . 518
Pre-collision warning 266
Seat belt 515, 516
SRS airbag 514
Tire pressure 516
Warning lights 513
ABS 514
Brake hold operated indicator
..... 519
Brake Override System 514

Brake system 513
 Charging system 513
 Cruise control indicator 517
 Drive-Start Control 514
 Driving assist information indicator 517
 Dynamic radar cruise control indicator 518
 Electric power steering 515
 Intuitive parking assist OFF indicator 517
 LDA indicator 516
 LTA indicator 516
 Parking brake indicator 518
 Pre-collision system 518
 Seat belt reminder light 515, 516
 Slip indicator 518
 SRS airbag 514
 Tire pressure 516
 Traction battery charge 515
Warning messages..... 522
Washer
 Low washer fluid warning message 471
 Preparing and checking before winter 393
 Switch 253
Washing and waxing 448, 451
Weight
 Cargo capacity 225, 228
 Load limits 228
 Weight 550
Wheel bolt wrench 486, 528
Wheels..... 493
 Replacing wheels 493
 Size 555
Window glasses
 Power windows 212
Window lock switch 214
Windows
 Power windows 212
 Rear window defogger 404

Washer 253
Windshield defogger 403
Windshield wipers
 Intermittent windshield wipers 253
 Position 253
 Rain-sensing windshield wipers 253
Winter driving tips 393
Wireless charger..... 430
Wireless charger tray lights .. 415
Wireless remote control..... 164
 Battery-saving function 188
 Locking/Unlocking 164
 Panic mode 164
 Remote Air Conditioning System 409
 Replacing the battery 497

X

X-MODE 382
 Grip Control 382

For vehicles with Premium Audio with Navigation or Audio Plus, refer to "MULTIMEDIA OWNER'S MANUAL" for information regarding the equipment listed below.

- Navigation system
- Audio system
- Rear view monitor system
- Panoramic view monitor

Certifications

Safety Connect

FCC ID: JOYCW1011

NOTE

This device complies with part 15 of the FCC Rules. Operation is subject to the following two conditions: (1) This device may not cause harmful interference, and (2) this device must accept any interference received, including interference that may cause undesired operation.

FCC WARNING

Changes or modifications not expressly approved by the party responsible for compliance could void the user's authority to operate the equipment.

Co-location: This transmitter must not be co-located or operated in conjunction with any other antenna or transmitter.

CAUTION : Radio Frequency Radiation Exposure

This equipment complies with FCC radiation exposure limits set forth for an uncontrolled environment and meets the FCC radio frequency (RF) Exposure Guidelines. This equipment should be installed and operated keeping the radiator at least 20cm or more away from person's body.

IC: 574B-CW1011

NOTE

This device contains licence-exempt transmitter(s)/receiver(s) that comply with Innovation, Science and Economic Development Canada's licence-exempt RSS(s). Operation is subject to the following two conditions:

(1) This device may not cause interference.

(2) This device must accept any interference, including interference that may cause undesired operation of the device.

The antenna cannot be removed (and changed) by user.

Co-location: This transmitter must not be co-located or operated in conjunction with any other antenna or transmitter.

CAUTION: Radio Frequency Radiation Exposure

This equipment complies with ISED radiation exposure limits set forth for an uncontrolled environment and meets RSS-102 of the ISED radio frequency (RF) Exposure rules. This equipment should be installed and operated keeping the radiator at least 20 cm or more away from person's body.

NOTE

L'émetteur/récepteur exempt de licence contenu dans le présent appareil est conforme aux CNR d'Innovation, Sciences et Développement économique Canada applicables aux appareils radio exempts de licence. L'exploitation est autorisée aux deux conditions suivantes :

- (1) L'appareil ne doit pas produire de brouillage;
- (2) L'appareil doit accepter tout brouillage radioélectrique subi, même si le brouillage est susceptible d'en compromettre le fonctionnement.

L'utilisateur n'est pas autorisé à retirer (ou modifier) l'antenne.

Emplacement: Cet émetteur ne doit pas être installé ou utilisé conjointement avec d'autres antennes ou émetteurs.

ATTENTION : exposition aux radiofréquences

Cet équipement est conforme aux limites d'exposition aux rayonnements ISDE établies pour un environnement non contrôlé et satisfait à la norme CNR-102 de la réglementation ISDE sur l'exposition aux radiofréquences (RF). Cet équipement doit être installé et utilisé avec un minimum de 20 cm de distance entre la source de rayonnement et le corps.

Immobilizer system

- For vehicles sold in the U.S.A. and Hawaii

FCC ID: NI4TMLF19D-3

NOTE

This device complies with part 15 of the FCC Rules. Operation is subject to the following two conditions: (1) This device may not cause harmful interference, and (2) this device must accept any interference received, including interference that may cause undesired operation.

FCC WARNING

Changes or modifications not expressly approved by the party responsible for compliance could void the user's authority to operate the equipment.

► For vehicles sold in Canada

NOTE

This device contains licence-exempt transmitter(s)/receiver(s) that comply with Innovation, Science and Economic Development Canada's licence-exempt RSS(s). Operation is subject to the following two conditions:

- (1) This device may not cause interference.
- (2) This device must accept any interference, including interference that may cause undesired operation of the device.

NOTE

L'émetteur/récepteur exempt de licence contenu dans le présent appareil est conforme aux CNR d'Innovation, Sciences et Développement économique Canada applicables aux appareils radio exempts de licence. L'exploitation est autorisée aux deux conditions suivantes:

- (1) L'appareil ne doit pas produire de brouillage;
- (2) L'appareil doit accepter tout brouillage radioélectrique subi, même si le brouillage est susceptible d'en compromettre le fonctionnement.

Digital key

- ▶ For vehicles sold in the U.S.A. and Hawaii

FCC ID:HYQ17EAA

NOTE

This device complies with part 15 of the FCC Rules. Operation is subject to the following two conditions: (1) This device may not cause harmful interference, and (2) this device must accept any interference received, including interference that may cause undesired operation.

FCC WARNING

Changes or modifications not expressly approved by the party responsible for compliance could void the user's authority to operate the equipment.

CAUTION : Radio Frequency Radiation Exposure

This equipment complies with FCC radiation exposure limits set forth for an uncontrolled environment and meets the FCC radio frequency (RF) Exposure Guidelines. This equipment should be installed and operated keeping the radiator at least 20cm or more away from person's body.

Co-location: This transmitter must not be co-located or operated in conjunction with any other antenna or transmitter.

► For vehicles sold in Canada

This device contains licence-exempt transmitter(s)/receiver(s) that comply with Innovation, Science and Economic Development Canada's licence-exempt RSS(s). Operation is subject to the following two conditions:

- (1) This device may not cause interference.
- (2) This device must accept any interference, including interference that may cause undesired operation of the device.

The antenna cannot be removed (and changed) by user.

Co-location: This transmitter must not be co-located or operated in conjunction with any other antenna or transmitter.

CAUTION: Radio Frequency Radiation Exposure

This equipment complies with ISED radiation exposure limits set forth for an uncontrolled environment and meets RSS-102 of the ISED radio frequency (RF) Exposure rules. This equipment should be installed and operated keeping the radiator at least 20 cm or more away from person's body.

L'émetteur/récepteur exempt de licence contenu dans le présent appareil est conforme aux CNR d'Innovation, Sciences et Développement économique Canada applicables aux appareils radio exempts de licence. L'exploitation est autorisée aux deux conditions suivantes :

- (1) L'appareil ne doit pas produire de brouillage;
- (2) L'appareil doit accepter tout brouillage radioélectrique subi, même si le brouillage est susceptible d'en compromettre le fonctionnement.

L'utilisateur n'est pas autorisé à retirer (ou modifier) l'antenne.

Emplacement : Cet émetteur ne doit pas être installé ou utilisé conjointement avec d'autres antennes ou émetteurs.

ATTENTION : exposition aux radiofréquences

Cet équipement est conforme aux limites d'exposition aux rayonnements d'ISDE établies pour un environnement non contrôlé ainsi que la norme CNR-102 de la réglementation d'ISDE relative à l'exposition aux radiofréquences (RF). Cet équipement doit être installé et utilisé avec un minimum de 20 cm de distance entre la source de rayonnement et le corps.

Smart key system

- ▶ For vehicles sold in the U.S.A. and Hawaii

FCC ID:HYQ23ABN
FCC ID:HYQ14FBX

NOTE:

This device complies with part 15 of the FCC Rules. Operation is subject to the following two conditions: (1) This device may not cause harmful interference, and (2) this device must accept any interference received, including interference that may cause undesired operation.

FCC WARNING:

Changes or modifications not expressly approved by the party responsible for compliance could void the user's authority to operate the equipment.

<For 14FBX>

The FCC ID is affixed inside the equipment. You can find the ID when replacing the battery.

- ▶ For vehicles sold in Canada

NOTE:

This device contains licence-exempt transmitter(s)/receiver(s) that comply with Innovation, Science and Economic Development Canada's licence-exempt RSS(s).

Operation is subject to the following two conditions:

- (1) This device may not cause interference.
- (2) This device must accept any interference, including interference that may cause undesired operation of the device.

<For 14FBX>

The IC Certification number is affixed inside the equipment. You can find the number when replacing the battery.

NOTE:

L'émetteur/récepteur exempt de licence contenu dans le présent appareil est conforme aux CNR d'Innovation, Sciences et Développement économique Canada applicables aux appareils radio exempts de licence.

L'exploitation est autorisée aux deux conditions suivantes :

- (1) L'appareil ne doit pas produire de brouillage;
- (2) L'appareil doit accepter tout brouillage radioélectrique subi, même si le brouillage est susceptible d'en compromettre le fonctionnement.

<Pour 14FBX>

Le numéro d'accréditation IC est apposé à l'intérieur de l'appareil. Ce numéro est visible au remplacement de la pile.

Toyota Safety Sense 3.0

- For vehicles sold in the U.S.A. and Hawaii

FCC ID: HYQDNMWR011

NOTE:

This device complies with part 15 of the FCC Rules. Operation is subject to the following two conditions: (1) This device may not cause harmful interference, and (2) this device must accept any interference received, including interference that may cause undesired operation.

FCC WARNING:

Changes or modifications not expressly approved by the party responsible for compliance could void the user's authority to operate the equipment.

Radiofrequency radiation exposure Information:

This equipment complies with FCC radiation exposure limits set forth for an uncontrolled environment. This equipment should be installed and operated with minimum distance of 20 cm between the radiator (antenna) and your body. This transmitter must not be co-located or operating in conjunction with any other antenna or transmitter.

► For vehicles sold in Canada

NOTE:

This device contains licence-exempt transmitter(s)/receiver(s) that comply with Innovation, Science and Economic Development Canada's licence-exempt RSS(s). Operation is subject to the following two conditions:

- (1) This device may not cause interference.
- (2) This device must accept any interference, including interference that may cause undesired operation of the device.

This equipment complies with ISED radiation exposure limits set forth for an uncontrolled environment and meets RSS-102 of the ISED radio frequency (RF) Exposure rules. This equipment should be installed and operated keeping the radiator at least 20 cm or more away from person's body.

NOTE:

L'émetteur/récepteur exempt de licence contenu dans le présent appareil est conforme aux CNR d'Innovation, Sciences et Développement économique Canada applicables aux appareils radio exempts de licence. L'exploitation est autorisée aux deux conditions suivantes :

- 1) L'appareil ne doit pas produire de brouillage;
- 2) L'appareil doit accepter tout brouillage radioélectrique subi, même si le brouillage est susceptible d'en compromettre le fonctionnement.

Cet équipement est conforme aux limites d'exposition aux rayonnements énoncées pour un environnement non contrôlé et respecte les règles d'exposition aux fréquences radioélectriques (RF) CNR-102 de l'ISDE. Cet équipement doit être installé et utilisé en gardant une distance de 20 cm ou plus entre le dispositif rayonnant et le corps.

BSM (Blind Spot Monitor)

- ▶ For vehicles sold in the U.S.A. and Hawaii

FCC ID : OAYSRR3A

This device complies with part 15 of the FCC Rules. Operation is subject to the following two conditions:

- (1) This device may not cause harmful interference, and
- (2) this device must accept any interference received, including interference that may cause undesired operation.

FCC Warning

Changes or modifications not expressly approved by the party responsible for compliance could void the user's authority to operate the equipment.

C3-002

- ▶ For vehicles sold in Canada

This device contains licence-exempt transmitter(s)/receiver(s) that comply with Innovation, Science and Economic Development Canada's licence-exempt RSS(s). Operation is subject to the following two conditions:

1. This device may not cause interference.
2. This device must accept any interference, including interference that may cause undesired operation of the device.

Radiofrequency radiation exposure information:

This equipment complies with radiation exposure limits set forth for an uncontrolled environment. This equipment should be installed and operated with minimum distance of 20 cm between the radiator and your body.

C3-005

L'émetteur/récepteur exempt de licence contenu dans le présent appareil est conforme aux CNR d'Innovation, Sciences et Développement économique Canada applicables aux appareils radio exempts de licence. L'exploitation est autorisée aux deux conditions suivantes:

1. L'appareil ne doit pas produire de brouillage;
2. L'appareil doit accepter tout brouillage radioélectrique subi, même si le brouillage est susceptible d'en compromettre le fonctionnement.

Informations sur l'exposition aux rayonnements radiofréquences:
Cet équipement est conforme aux limites d'exposition aux rayonnements définies pour un environnement non contrôlé. Cet équipement doit être installé et utilisé avec un minimum de 20 cm de distance entre la source de rayonnement et votre corps.

C3-006

Wireless charger

- ▶ For vehicles sold in the U.S.A. and Hawaii

FCC ID: ACJ932AT2001

NOTE:

This device complies with part 15 and part 18 of the FCC Rules. Operation is subject to the following two conditions: (1) This device may not cause harmful interference, and (2) this device must accept any interference received, including interference that may cause undesired operation.

FCC CAUTION

Changes or modifications not expressly approved by the party responsible for compliance could void the user's authority to operate the equipment.

This equipment has been tested and found to comply with the limits for a wireless power charger, pursuant to part 18 of the FCC Rules.

This equipment generates, uses and can radiate radio frequency energy and, if not installed and used in accordance with the instructions, may cause harmful interference to radio communications.

However, there is no guarantee that interference will not occur in a particular installation.

If this equipment does cause harmful interference to radio communications, which can be determined by turning the equipment off and on, the user is encouraged to try to correct the interference by one or more of the following measures:

- Reorient or relocate the receiving antenna.
- Increase the separation between the equipment and receiver.
- Connect the equipment into an outlet on a circuit different from that to which the receiver is connected.

This equipment complies with FCC radiation exposure limits set forth for an uncontrolled environment and meets the FCC radio frequency (RF) Exposure Guidelines. This equipment should be installed and operated keeping the radiator at least 20cm or more away from person's body.

► For vehicles sold in Canada

This device contains licence-exempt transmitter(s)/receiver(s) that comply with Innovation, Science and Economic Development Canada's licence-exempt RSS(s). Operation is subject to the following two conditions:

- (1) This device may not cause interference.
- (2) This device must accept any interference, including interference that may cause undesired operation of the device.

L'émetteur/récepteur exempt de licence contenu dans le présent appareil est conforme aux CNR d'Innovation, Sciences et Développement économique Canada applicables aux appareils radio exempts de licence. L'exploitation est autorisée aux deux conditions suivantes :

- 1) L'appareil ne doit pas produire de brouillage;
- 2) L'appareil doit accepter tout brouillage radioélectrique subi, même si le brouillage est susceptible d'en compromettre le fonctionnement.

CAUTION

This equipment complies with ISED radiation exposure limits set forth for an uncontrolled environment and meets RSS-102 of the ISED radio frequency (RF) Exposure rules. This equipment should be installed and operated keeping the radiator at least 20cm or more away from person's body.

Cet équipement est conforme aux limites d'exposition aux rayonnements énoncées pour un environnement non contrôlé et respecte les règles d'exposition aux fréquences radioélectriques (RF) CNR-102 de l'ISDE. Cet équipement doit être installé et utilisé en gardant une distance de 20 cm ou plus entre le radiateur et le corps humain.

Garage door opener

► For vehicles sold in the U.S. mainland and Hawaii

This device complies with FCC rules part 15 and Innovation, Science, and Economic Development Canada RSS-210. Operation is subject to the following two conditions: (1) This device may not cause harmful interference, and (2) This device must accept any interference that may be received including interference that may cause undesired operation. **WARNING:** The transmitter has been tested and complies with FCC and ISED rules. Changes or modifications not expressly approved by the party responsible for compliance could void the user's authority to operate the device.

This equipment complies with FCC and ISED radiation exposure limits set forth for an uncontrolled environment. End Users must follow the specific operating instructions for satisfying RF exposure compliance. This transmitter must be at least 20 cm from the user and must not be co-located or operating in conjunction with any other antenna or transmitter.

► For vehicles sold in Canada

This device complies with FCC rules part 15 and Innovation, Science, and Economic Development Canada RSS-210. Operation is subject to the following two conditions: (1) This device may not cause harmful interference, and (2) This device must accept any interference that may be received including interference that may cause undesired operation. **WARNING:** The transmitter has been tested and complies with FCC and ISSED rules. Changes or modifications not expressly approved by the party responsible for compliance could void the user's authority to operate the device.

This equipment complies with FCC and ISSED radiation exposure limits set forth for an uncontrolled environment. End Users must follow the specific operating instructions for satisfying RF exposure compliance. This transmitter must be at least 20 cm from the user and must not be co-located or operating in conjunction with any other antenna or transmitter.

Cet appareil est conforme aux règlements de la FCC, section 15, et au CNR-210 d'Innovation, Sciences et Développement économique Canada. Le fonctionnement est assujéti aux deux conditions suivantes : (1) cet appareil ne doit pas causer d'interférences nuisibles et (2) cet appareil doit accepter toute interférence reçue, y compris celle qui pourrait entraîner un dysfonctionnement. **MISE EN GARDE :** L'émetteur a subi des tests et est conforme aux règlements de la FCC et d'ISDE. Les changements ou modifications non approuvés explicitement par la partie responsable de la conformité pourraient rendre caduque l'autorisation de l'utilisateur de se servir du dispositif.

Cet appareil est conforme aux limites d'exposition aux radiations de la FCC et d'ISDE établies pour un environnement non contrôlé. Les utilisateurs finaux doivent respecter les instructions d'utilisation spécifiques pour satisfaire aux exigences de conformité aux expositions de RF. L'émetteur doit se trouver à 20 cm au minimum de l'utilisateur et ne doit pas être situé au même endroit que tout autre émetteur ou antenne ni fonctionner avec un autre émetteur ou antenne.

Tire pressure warning system

► For vehicles sold in the U.S.A. and Hawaii

FCC ID: PAXPMVE000

NOTE

This device complies with part 15 of the FCC Rules. Operation is subject to the following two conditions:
 (1) This device may not cause harmful interference, and (2) this device must accept any interference received, including interference that may cause undesired operation.

FCC WARNING

Changes or modifications not expressly approved by the party responsible for compliance could void the user's authority to operate the equipment.

FCC ID: PAXPMVE100

NOTE

This device complies with part 15 of the FCC Rules. Operation is subject to the following two conditions:

(1) This device may not cause harmful interference, and (2) this device must accept any interference received, including interference that may cause undesired operation.

FCC WARNING

Changes or modifications not expressly approved by the party responsible for compliance could void the user's authority to operate the equipment.

"Perchlorate Material – special handling may apply, See www.dtsc.ca.gov/hazardouswaste/perchlorate."

- ▶ For vehicles sold in Canada

NOTE

This device complies with Industry Canada licence-exempt RSS standard(s). Operation is subject to the following two conditions: (1) this device may not cause interference, and (2) this device must accept any interference, including interference that may cause undesired operation of the device.

NOTE

Le présent appareil est conforme aux CNR d'Industrie Canada applicables aux appareils radio exempts de licence. L'exploitation est autorisée aux deux conditions suivantes : (1) l'appareil ne doit pas produire de brouillage, et (2) l'utilisateur de l'appareil doit accepter tout brouillage radioélectrique subi, même si le brouillage est susceptible d'en compromettre le fonctionnement.

CHARGING STATION INFORMATION

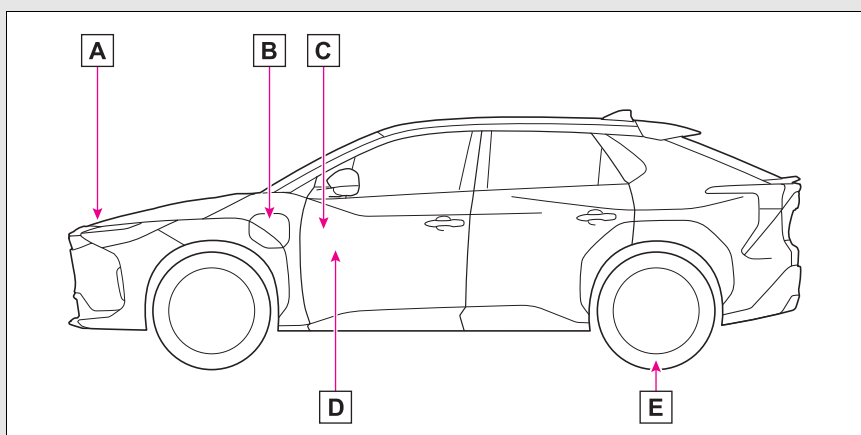

- A** Auxiliary catch lever (→P.462)
- B** Charging port lid (→P.85)
- C** Power back door switch* (→P.176)
- D** Hood lock release lever (→P.462)
- E** Tire inflation pressure (→P.555)

*: If equipped

| | |
|------------------------------|-------|
| External power source | P.98 |
| Time needed for charging | P.101 |
| Traction battery type | P.552 |
| Cold tire inflation pressure | P.555 |